

1 2 3 4 5 6 7 8

# LOW VOLTAGE

# HIGH VOLTAGE

A  
B  
C  
D  
E  
F

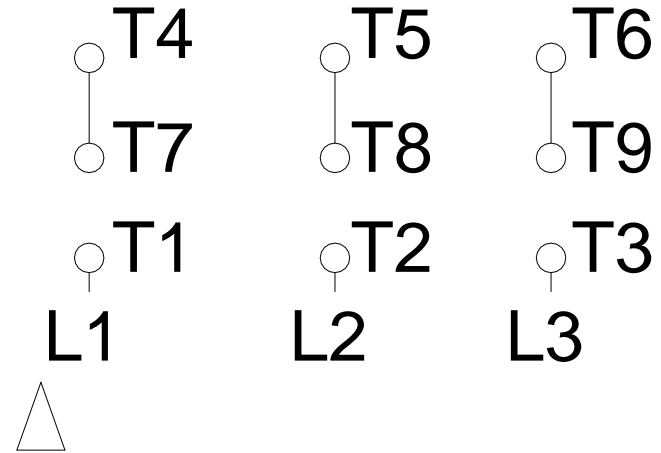
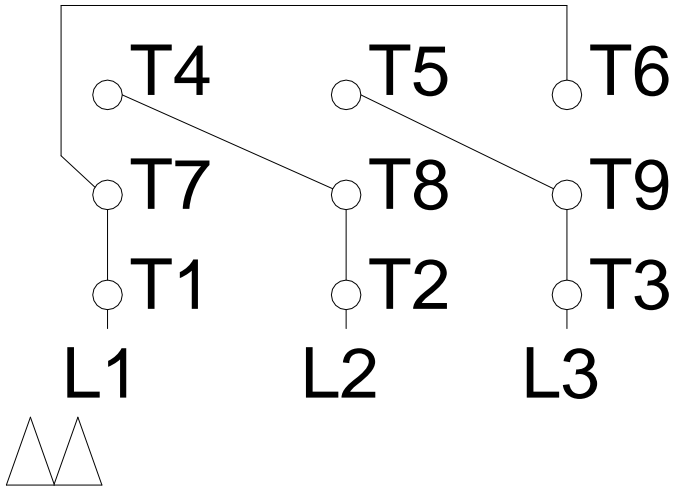

Notes: Downloaded from <http://dealerselectric.com>  
Generated for Model #00736OP3E184JMV

Performed by:

Checked:

Customer:

Close Coupled Pump : Three-Phase - "JM" Type - ODP - High Efficiency -

Three-phase induction motor  
Frame 184JM - IP21

13-SEP-2016

