

# LOW VOLTAGE

# HIGH VOLTAGE

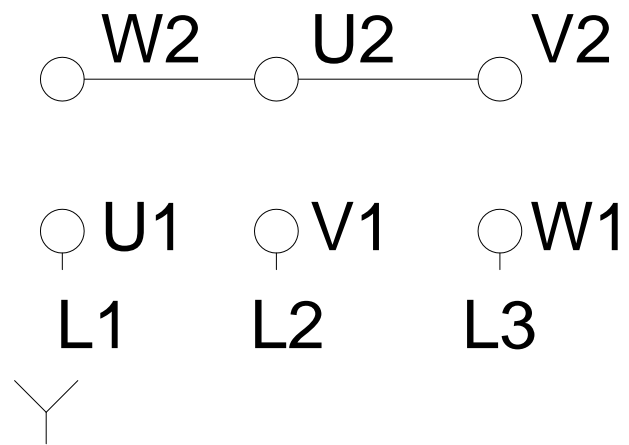
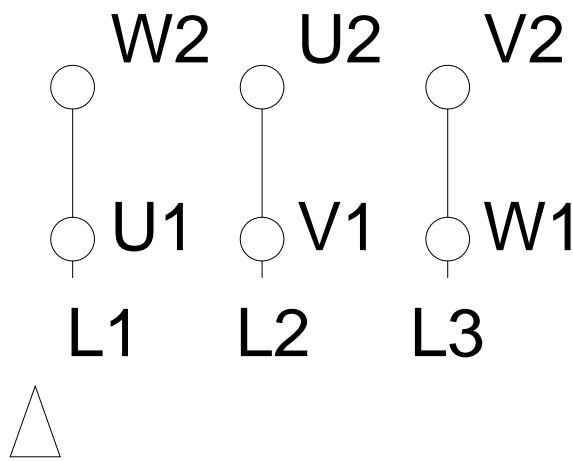

Notes: Downloaded from <http://dealerselectric.com>  
Generated for Model #00718ET3YAL132M

Performed by:

Checked:

Customer:

Three-Phase: W21 IE3 IEC Tru-Metric - TEFC (IP55) Multi-Mounting Aluminum

Three-phase induction motor  
Frame 132M - IP55

13-SEP-2016

