

LOW VOLTAGE

HIGH VOLTAGE

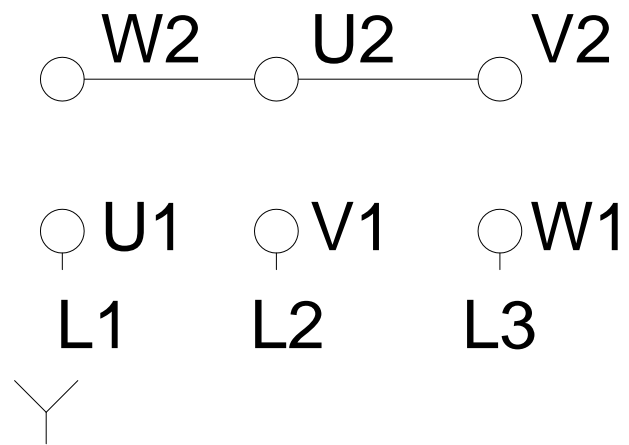
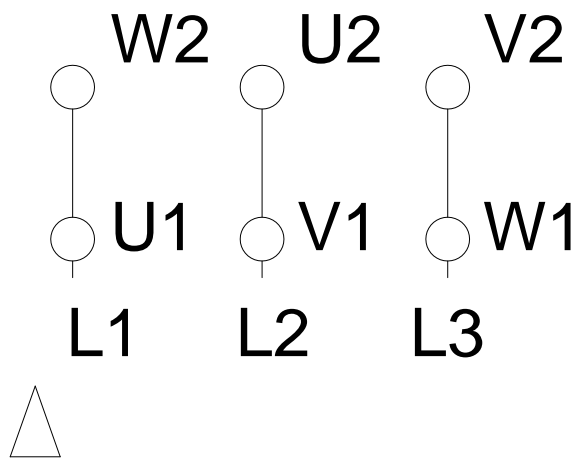

Notes: Downloaded from <http://dealerselectric.com>
Generated for Model #00436ET3YAL112M

Performed by:

Checked:

Customer:

Three-Phase: W21 IE3 IEC Tru-Metric - TEFC (IP55) Multi-Mounting Aluminum

Three-phase induction motor
Frame 112M - IP55

13-SEP-2016

