



Dealers Industrial Equipment

No.:

Date: 29-SEP-2016

Customer :

TECHNICAL PROPOSAL

Single-phase induction motor - Squirrel cage rotor

Product line : Pool & Spa Motors : Square Flange - Start Capacitor - High Service Factor

Catalog Number : PCQ105H

List Price : \$241

Notes:

Downloaded from <http://dealerselectric.com>

Generated for Model #PCQ105H

Performed by:

Checked:



Dealers Industrial Equipment

No.:

Date: 29-SEP-2016

DATA SHEET Single-phase induction motor - Squirrel cage rotor

Customer :
Product line : Pool & Spa Motors : Square Flange - Start Capacitor - High Service Factor

Frame : K48Y
Output : 0.5 HP
Frequency : 60 Hz
Poles : 2
Full load speed : 3515 rpm
Slip : 2.36 %
Voltage : 115/230 V
Rated current : 9.10/4.55 A
Locked rotor current : 53.7/26.8 A
Locked rotor current (I_L/I_n) : 5.9
No-load current : 7.70/3.85 A
Full load torque : 0.737 lb.ft
Locked rotor torque : 210 %
Breakdown torque : 400 %
Design : ---
Insulation class : B
Temperature rise : 80 K
Locked rotor time : 6 s (hot)
Service factor : 1.90
Duty cycle : S1
Ambient temperature : -20°C - +50°C
Altitude : 1000 m
Degree of Protection : IP21
Approximate weight : 24 lb
Moment of inertia : 0.02326 sq.ft.lb
Noise level : ---

	D.E.	N.D.E.	Load	Power factor	Efficiency (%)
Bearings	6203 2RS	6203 ZZ	100%	0.59	60.4
Regreasing interval	---	---	75%	0.52	54.0
Grease amount	---	---	50%	0.43	45.0

Notes:

Downloaded from <http://dealerselectric.com>
Generated for Model #PCQ105H

Performed by

Checked



Dealers Industrial Equipment

No.:

Date: 29-SEP-2016

PERFORMANCE CURVES RELATED TO RATED OUTPUT

Single-phase induction motor - Squirrel cage rotor

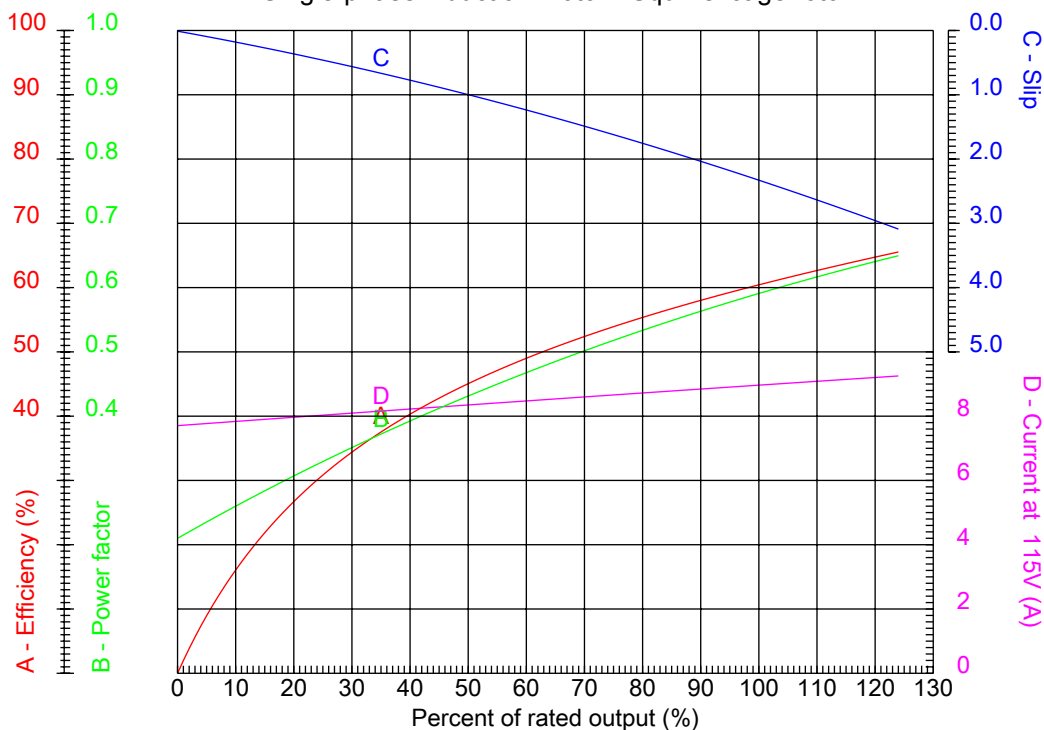

Customer :
 Product line : Pool & Spa Motors : Square Flange - Start Capacitor - High Service Factor

Frame	: K48Y	Locked rotor current (I _l /I _n)	: 5.9
Output	: 0.5 HP	Duty cycle	: S1
Frequency	: 60 Hz	Service factor	: 1.90
Full load speed	: 3515 rpm	Design	: ---
Voltage	: 115/230 V	Locked rotor torque	: 210 %
Rated current	: 9.10/4.55 A	Breakdown torque	: 400 %
Insulation class	: B		

Notes:
 Downloaded from <http://dealerselectric.com>
 Generated for Model #PCQ105H

Performed by

Checked

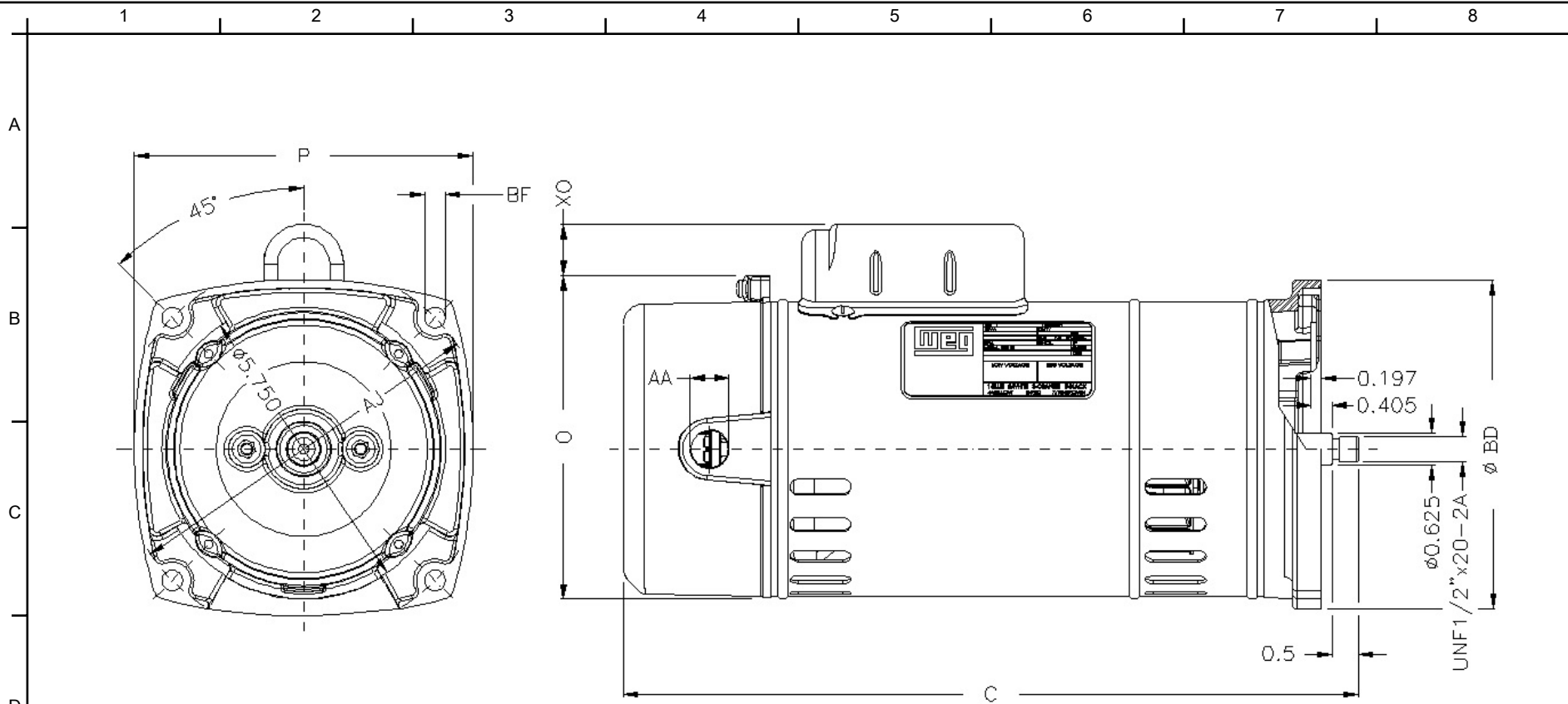

Notes: Downloaded from <http://dealerselectric.com>
 Generated for Model #PCQ105H

Performed by:

Checked:

Customer:

Pool & Spa Motors : Square Flange - Start Capacitor - High Service Factor

P 6.496	C 12.913	XO 1.023	AA NPT 1/2"	Flange FC-149
AJ 7.126	BF 10			

Single-phase induction motor
 Frame K48Y - IP21

29-SEP-2016

