



Dealers Industrial Equipment

No.:

Date: 29-SEP-2016

Customer :

TECHNICAL PROPOSAL

Three-phase induction motor - Squirrel cage rotor

Product line : W22 NEMA Premium - Ball Bearings

Catalog Number : 70018ET3G588/9-W22

List Price : \$71,185

Notes:

Downloaded from <http://dealerselectric.com>

Generated for Model #70018ET3G588/9-W22

Performed by:

Checked:



Dealers Industrial Equipment

No.:

Date: 29-SEP-2016

DATA SHEET Three-phase induction motor - Squirrel cage rotor

Customer :
 Product line : W22 NEMA Premium - Ball Bearings

Frame : 588/9T
 Output : 700 HP
 Frequency : 60 Hz
 Poles : 4
 Full load speed : 1790 rpm
 Slip : 0.56 %
 Voltage : 460 V
 Rated current : 788 A
 Locked rotor current : 5120 A
 Locked rotor current (I_L/I_n) : 6.5
 No-load current : 240 A
 Full load torque : 2026 lb.ft
 Locked rotor torque : 250 %
 Breakdown torque : 220 %
 Design : B
 Insulation class : F
 Temperature rise : 80 K
 Locked rotor time : 23 s (hot)
 Service factor : 1.00
 Duty cycle : S1
 Ambient temperature : -20°C - +40°C
 Altitude : 1000 m
 Degree of Protection : IP55
 Approximate weight : 4584 lb
 Moment of inertia : 334.83 sq.ft.lb
 Noise level : 81 dB(A)

	D.E.	N.D.E.
Bearings	6322 C3	6319 C3
Regreasing interval	6000 h	8000 h
Grease amount	60 g	45 g

Load	Power factor	Efficiency (%)
100%	0.85	96.6
75%	0.81	96.5
50%	0.76	96.2

Notes:
 Downloaded from <http://dealerselectric.com>
 Generated for Model #70018ET3G588/9-W22

Performed by

Checked



Dealers Industrial Equipment

No.:

Date: 29-SEP-2016

PERFORMANCE CURVES RELATED TO RATED OUTPUT

Three-phase induction motor - Squirrel cage rotor

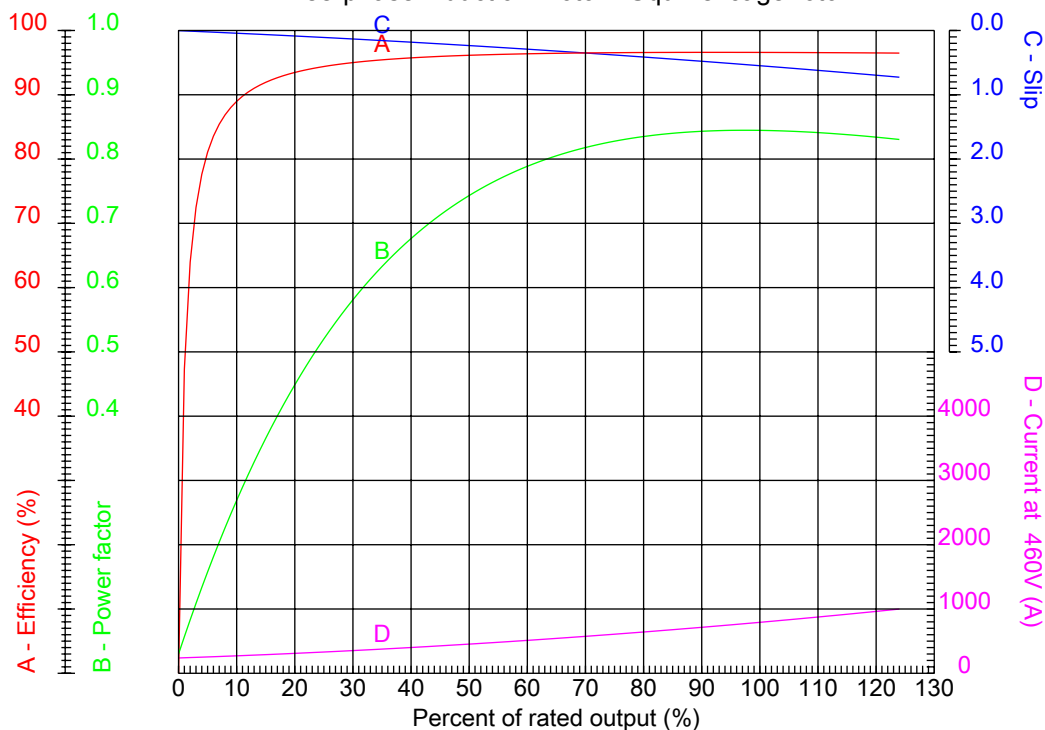

Customer :
Product line : W22 NEMA Premium - Ball Bearings

Frame : 588/9T	Locked rotor current (I _l /I _n) : 6.5
Output : 700 HP	Duty cycle : S1
Frequency : 60 Hz	Service factor : 1.00
Full load speed : 1790 rpm	Design : B
Voltage : 460 V	Locked rotor torque : 250 %
Rated current : 788 A	Breakdown torque : 220 %
Insulation class : F	

Notes:
Downloaded from <http://dealerselectric.com>
Generated for Model #70018ET3G588/9-W22

Performed by

Checked



Dealers Industrial Equipment

No.:

Date: 29-SEP-2016

CHARACTERISTIC CURVES RELATED TO SPEED

Three-phase induction motor - Squirrel cage rotor

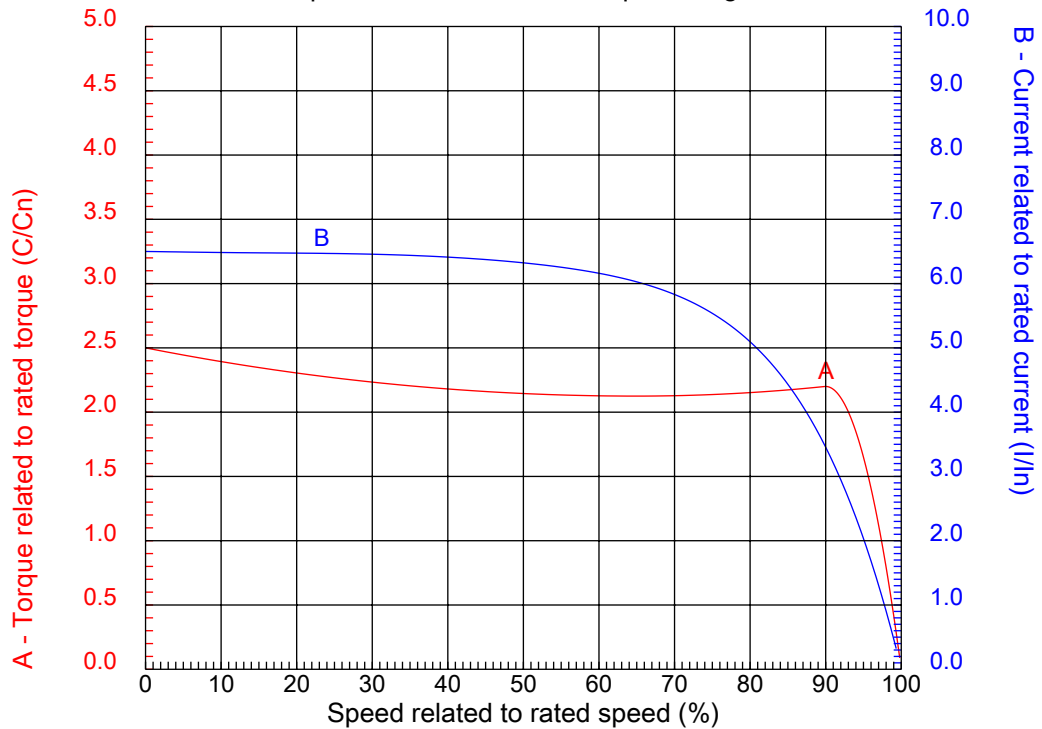

Customer :
Product line : W22 NEMA Premium - Ball Bearings

Frame	: 588/9T	Locked rotor current (I _l /I _n)	: 6.5
Output	: 700 HP	Duty cycle	: S1
Frequency	: 60 Hz	Service factor	: 1.00
Full load speed	: 1790 rpm	Design	: B
Voltage	: 460 V	Locked rotor torque	: 250 %
Rated current	: 788 A	Breakdown torque	: 220 %
Insulation class	: F		

Notes:
Downloaded from <http://dealerselectric.com>
Generated for Model #70018ET3G588/9-W22

Performed by

Checked

1 2 3 4 5 6 7 8

A

B

C

D

E

F

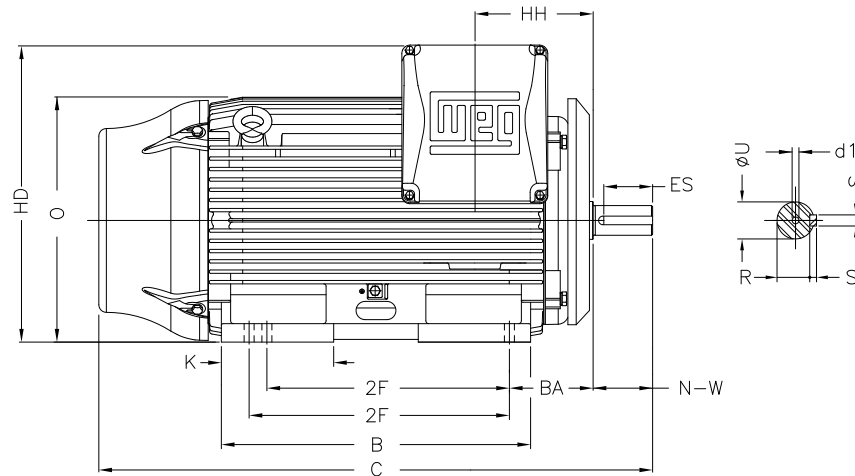
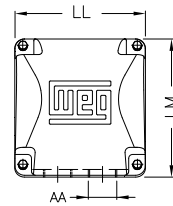
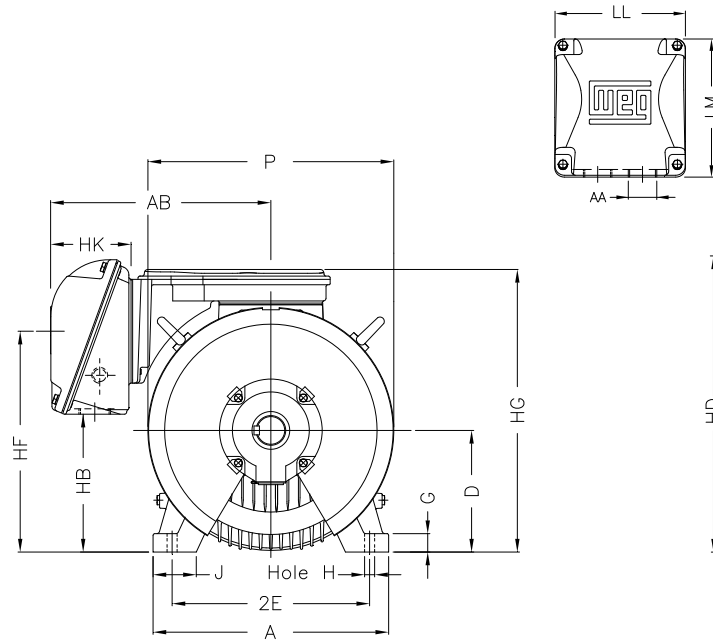

Notes: Downloaded from <http://dealerselectric.com>
Generated for Model #70018ET3G588/9-W22

2E 23.000	J 5.512	A 29.528	P 28.977	AB 27.440
2F 28.000/32.000	K 13.030	B 37.980	BA 10.000	U 3.875
N-W 11.625	ES 8.661	S 1.000	R 3.312	depth 1.000
D 14.500	G 2.492	HB 16.338	O 28.985	HD 37.755
HF 26.182	HG 35.236	HH 13.346	HK 11.417	EV 2.756
H 1.181	C 69.381	LL 18.110	LM 21.417	AA 2xNPT 4"
d1 DUNC 7/8"-9				

Performed by:

Checked:

Customer:

W22 NEMA Premium - Ball Bearings

Three-phase induction motor
Frame 588/9T - IP55

29-SEP-2016



1 2 3 4 5 6 7 8

A

PART-WINDING

WYE-DELTA

START

RUN

START

RUN

B



C

L1 L2 L3

L1 L2 L3

L1 L2 L3

L1 L2 L3

D

E

F

Notes: Downloaded from <http://dealerselectric.com>
 Generated for Model #70018ET3G588/9-W22

Performed by:

Checked:

Customer:

W22 NEMA Premium - Ball Bearings

Three-phase induction motor
 Frame 588/9T - IP55

29-SEP-2016

