



Dealers Industrial Equipment

No.:

Date: 29-SEP-2016

Customer :

TECHNICAL PROPOSAL

Three-phase induction motor - Squirrel cage rotor

Product line : W40 - Open Induction Motors – NEMA Premium Efficiency

Catalog Number : 60036OT3G447/9TS-W40

List Price : \$32,994

Notes:

Downloaded from <http://dealerselectric.com>

Generated for Model #60036OT3G447/9TS-W40

Performed by:

Checked:



Dealers Industrial Equipment

No.:

Date: 29-SEP-2016

DATA SHEET Three-phase induction motor - Squirrel cage rotor

Customer :
 Product line : W40 - Open Induction Motors – NEMA Premium Efficiency

Frame : 447/9TS
 Output : 600 HP
 Frequency : 60 Hz
 Poles : 2
 Full load speed : 3570 rpm
 Slip : 0.83 %
 Voltage : 460 V
 Rated current : 638 A
 Locked rotor current : 5040 A
 Locked rotor current (I_L/I_n) : 7.9
 No-load current : 160 A
 Full load torque : 871 lb.ft
 Locked rotor torque : 200 %
 Breakdown torque : 270 %
 Design : A
 Insulation class : F
 Temperature rise : 80 K
 Locked rotor time : 14 s (hot)
 Service factor : 1.15
 Duty cycle : S1
 Ambient temperature : -20°C - +40°C
 Altitude : 1000 m
 Degree of Protection : IP23
 Approximate weight : 2359 lb
 Moment of inertia : 53.612 sq.ft.lb
 Noise level : 87 dB(A)

	D.E.	N.D.E.
Bearings	6314 C3	6314 C3
Regreasing interval	14418 h	14418 h
Grease amount	27 g	27 g

Load	Power factor	Efficiency (%)
100%	0.90	96.2
75%	0.89	96.2
50%	0.83	95.8

Notes:
 Downloaded from <http://dealerselectric.com>
 Generated for Model #60036OT3G447/9TS-W40

Performed by

Checked



Dealers Industrial Equipment

No.:

Date: 29-SEP-2016

PERFORMANCE CURVES RELATED TO RATED OUTPUT

Three-phase induction motor - Squirrel cage rotor

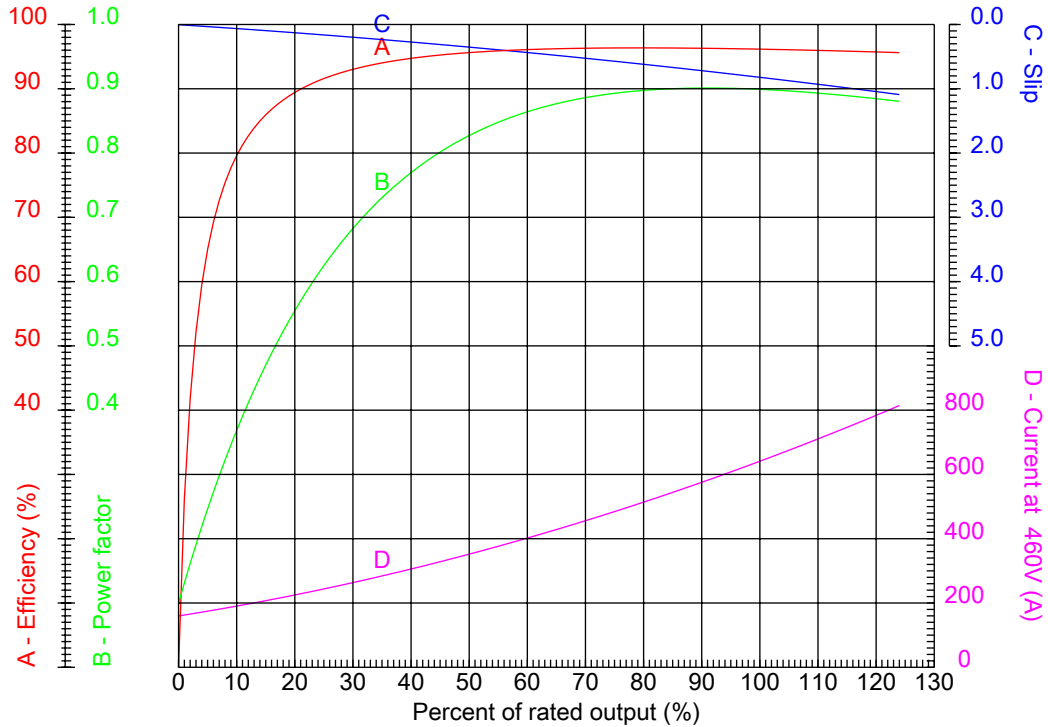

Customer :
Product line : W40 - Open Induction Motors – NEMA Premium Efficiency

Frame : 447/9TS	Locked rotor current (I _l /I _n) : 7.9
Output : 600 HP	Duty cycle : S1
Frequency : 60 Hz	Service factor : 1.15
Full load speed : 3570 rpm	Design : A
Voltage : 460 V	Locked rotor torque : 200 %
Rated current : 638 A	Breakdown torque : 270 %
Insulation class : F	

Notes:
Downloaded from <http://dealerselectric.com>
Generated for Model #60036OT3G447/9TS-W40

Performed by

Checked



Dealers Industrial Equipment

No.:

Date: 29-SEP-2016

CHARACTERISTIC CURVES RELATED TO SPEED

Three-phase induction motor - Squirrel cage rotor

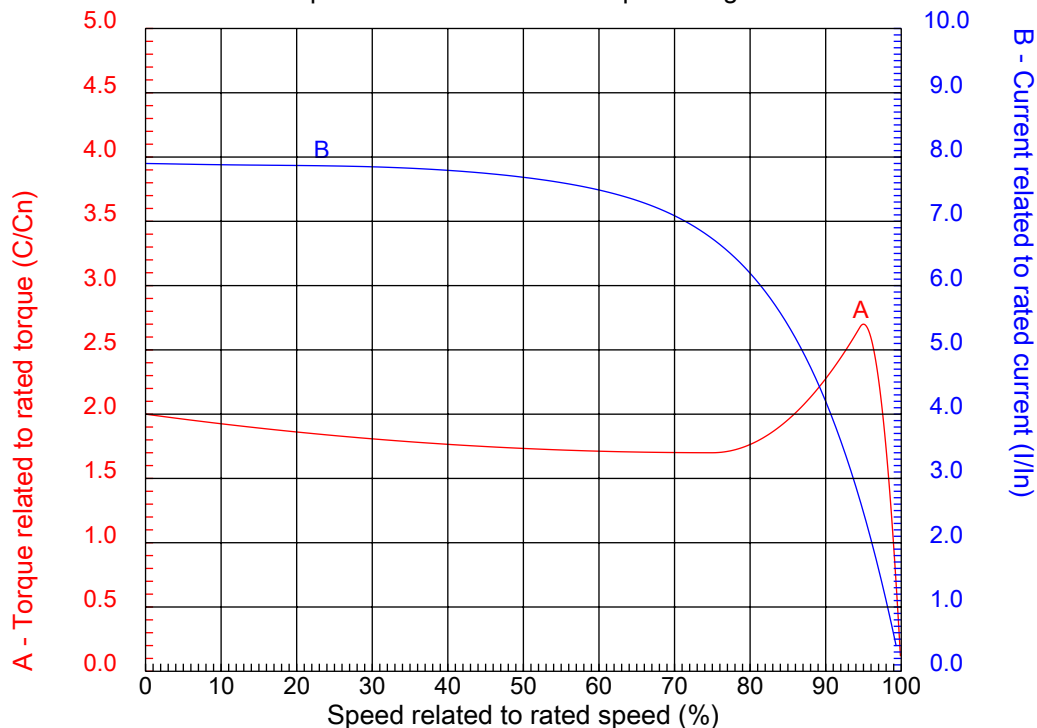

Customer :
Product line : W40 - Open Induction Motors – NEMA Premium Efficiency

Frame	: 447/9TS	Locked rotor current (I _l /I _n)	: 7.9
Output	: 600 HP	Duty cycle	: S1
Frequency	: 60 Hz	Service factor	: 1.15
Full load speed	: 3570 rpm	Design	: A
Voltage	: 460 V	Locked rotor torque	: 200 %
Rated current	: 638 A	Breakdown torque	: 270 %
Insulation class	: F		

Notes:
Downloaded from <http://dealerselectric.com>
Generated for Model #60036OT3G447/9TS-W40

Performed by

Checked

1 2 3 4 5 6 7 8

A

B

C

D

E

F

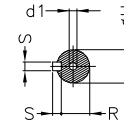
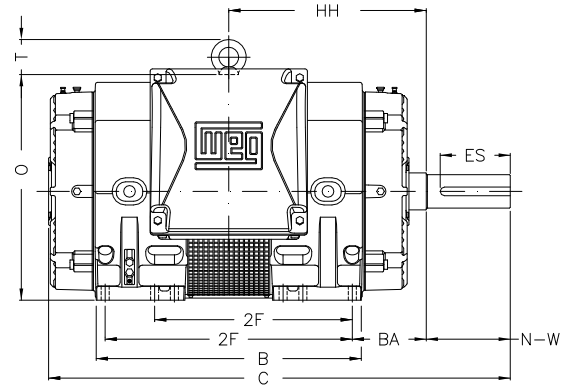
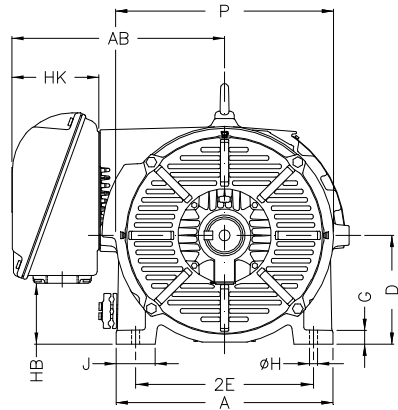
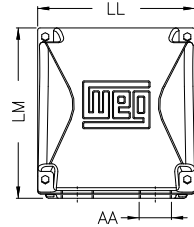

Notes: Downloaded from <http://dealerselectric.com>
Generated for Model #60036OT3G447/9TS-W40

2E 18.000	J 3.983	A 21.929	P 25.197	AB 21.505
2F 20.000/25.000	K 8.971	B 26.820	FK 8.971	EV 0.910
BA 7.480	U 2.375	d1 DUNC 3/4"-10	N-W 4.750	ES 3.000
S 0.625	R 2.021	depth 0.625	D 11.000	G 1.397
O 22.811	T 3.543	HH 19.980	H 0.810	C 42.959
AA 2xNPT 3"	DM NPT 3/4"	LL 15.904	LM 17.225	HK 8.907
HB 6.158				

Performed by:

Checked:

Customer:

W40 - Open Induction Motors – NEMA Premium Efficiency

Three-phase induction motor
Frame 447/9TS - IP23

29-SEP-2016

