



Dealers Industrial Equipment

No.:

Date: 29-SEP-2016

Customer :

TECHNICAL PROPOSAL

Three-phase induction motor - Squirrel cage rotor

Product line : ODP – Open Induction Motors – NEMA Premium Efficiency

Catalog Number : 50036OT3G447/9TS

List Price : \$>(discontinued)

Notes:

Downloaded from <http://dealerselectric.com>

Generated for Model #50036OT3G447/9TS

Performed by:

Checked:



Dealers Industrial Equipment

No.:

Date: 29-SEP-2016

DATA SHEET

Three-phase induction motor - Squirrel cage rotor

Customer :
 Product line : ODP – Open Induction Motors – NEMA Premium Efficiency

Frame : 447/9TS
 Output : 500 HP
 Frequency : 60 Hz
 Poles : 2
 Full load speed : 3570 rpm
 Slip : 0.83 %
 Voltage : 460 V
 Rated current : 536 A
 Locked rotor current : 3810 A
 Locked rotor current (I_L/I_n) : 7.1
 No-load current : 120 A
 Full load torque : 726 lb.ft
 Locked rotor torque : 190 %
 Breakdown torque : 250 %
 Design : A
 Insulation class : F
 Temperature rise : 80 K
 Locked rotor time : 14 s (hot)
 Service factor : 1.15
 Duty cycle : S1
 Ambient temperature : -20°C - +40°C
 Altitude : 1000 m
 Degree of Protection : IP23
 Approximate weight : 2139 lb
 Moment of inertia : 46.911 sq.ft.lb
 Noise level : 87 dB(A)

	D.E.	N.D.E.
Bearings	6314 C3	6314 C3
Regreasing interval	14418 h	14418 h
Grease amount	27 g	27 g

Load	Power factor	Efficiency (%)
100%	0.90	96.2
75%	0.89	96.2
50%	0.84	95.8

Notes:
 Downloaded from <http://dealerselectric.com>
 Generated for Model #50036OT3G447/9TS

Performed by

Checked



Dealers Industrial Equipment

No.:

Date: 29-SEP-2016

PERFORMANCE CURVES RELATED TO RATED OUTPUT

Three-phase induction motor - Squirrel cage rotor

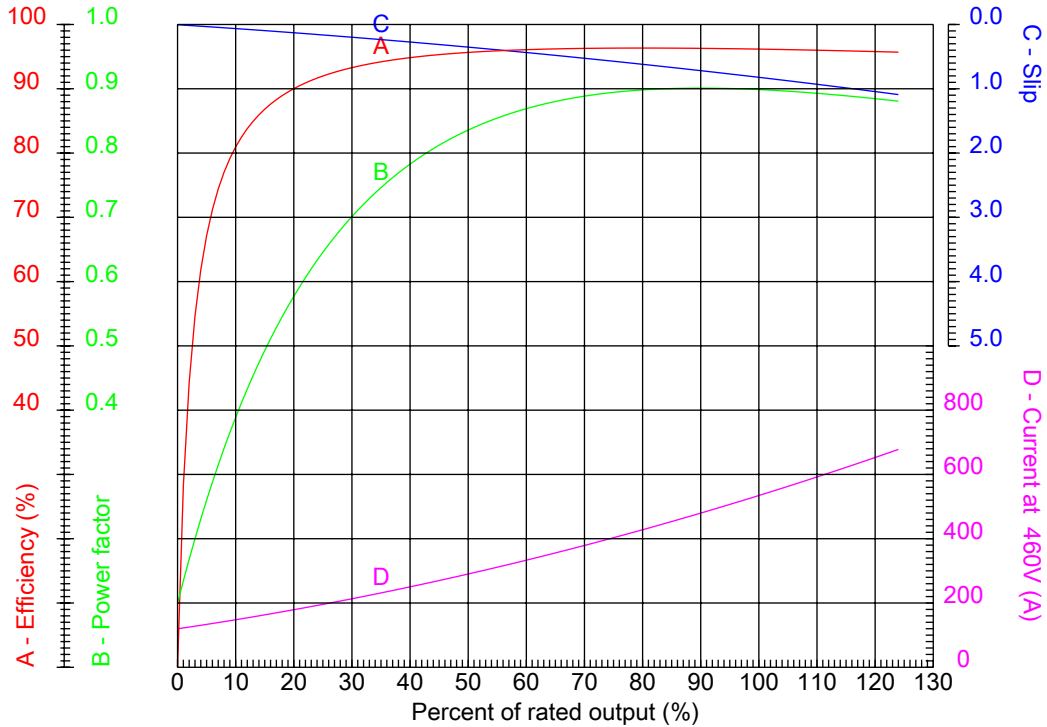

Customer :
Product line : ODP – Open Induction Motors – NEMA Premium Efficiency

Frame : 447/9TS	Locked rotor current (I _l /I _n) : 7.1
Output : 500 HP	Duty cycle : S1
Frequency : 60 Hz	Service factor : 1.15
Full load speed : 3570 rpm	Design : A
Voltage : 460 V	Locked rotor torque : 190 %
Rated current : 536 A	Breakdown torque : 250 %
Insulation class : F	

Notes:
Downloaded from <http://dealerselectric.com>
Generated for Model #50036OT3G447/9TS

Performed by

Checked



Dealers Industrial Equipment

No.:

Date: 29-SEP-2016

CHARACTERISTIC CURVES RELATED TO SPEED

Three-phase induction motor - Squirrel cage rotor

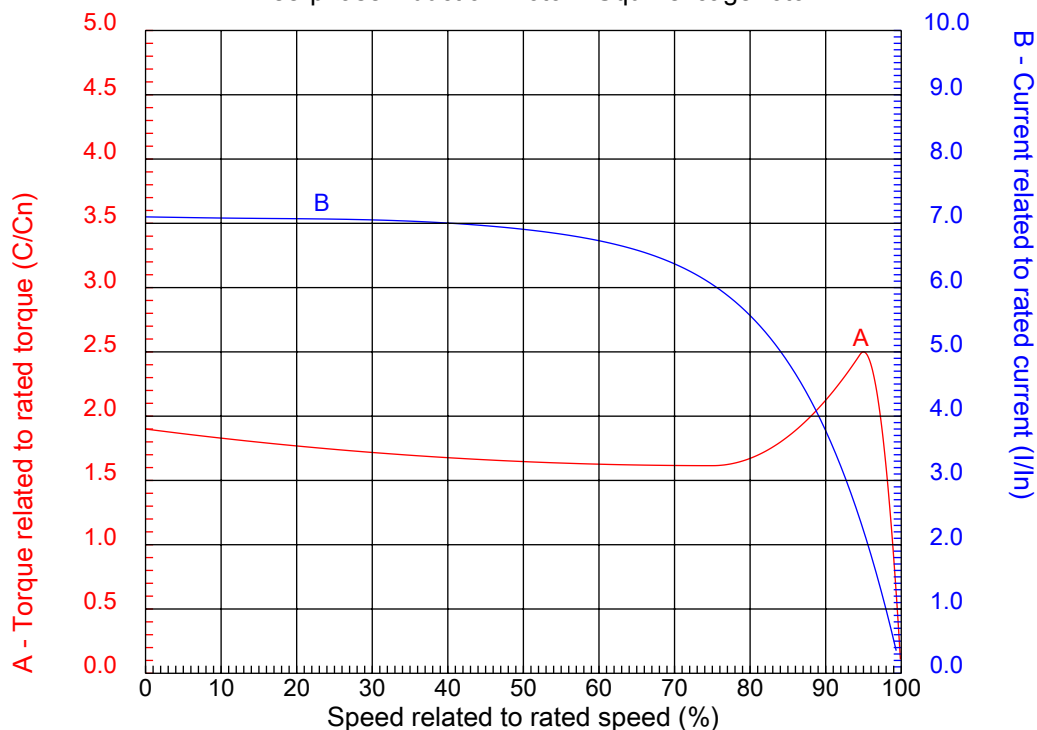

Customer :
Product line : ODP – Open Induction Motors – NEMA Premium Efficiency

Frame	: 447/9TS	Locked rotor current (I _l /I _h)	: 7.1
Output	: 500 HP	Duty cycle	: S1
Frequency	: 60 Hz	Service factor	: 1.15
Full load speed	: 3570 rpm	Design	: A
Voltage	: 460 V	Locked rotor torque	: 190 %
Rated current	: 536 A	Breakdown torque	: 250 %
Insulation class	: F		

Notes:
Downloaded from <http://dealerselectric.com>
Generated for Model #50036OT3G447/9TS

Performed by

Checked

1 2 3 4 5 6 7 8

A

B

C

D

E

F

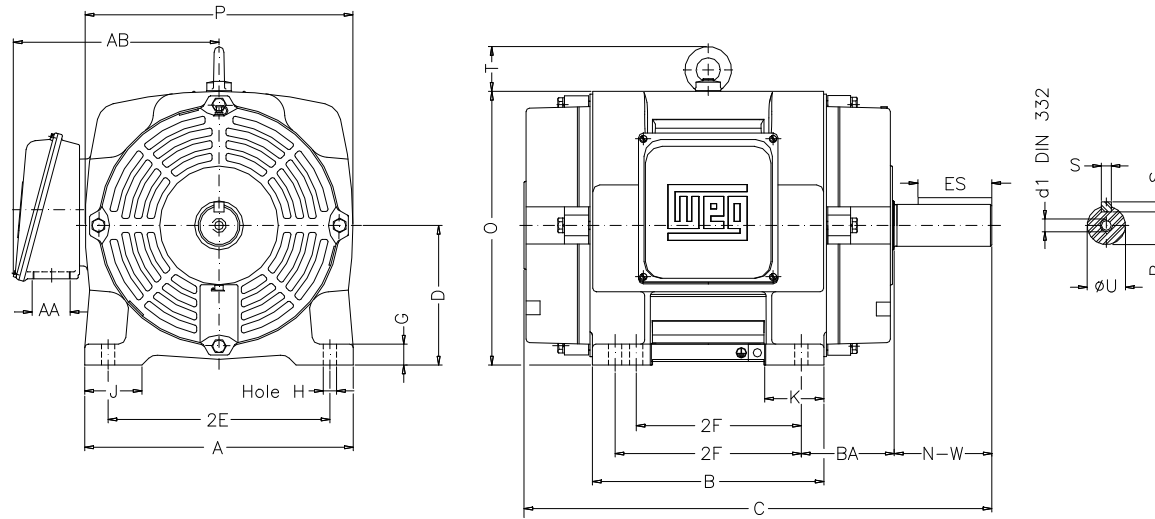

Notes: Downloaded from <http://dealerselectric.com>
Generated for Model #50036OT3G447/9TS

Performed by:

Checked:

Customer:

ODP – Open Induction Motors – NEMA Premium Efficiency

Three-phase induction motor
Frame 447/9TS - IP23

29-SEP-2016



2E 18.000	J 3.937	A 21.929	P 22.126	AB 23.464
2F 20.000/25.000	K 10.47	B 28.898	BA 7.500	U 2.375
d1 DUNC 3/4"-10	N-W 4.750	ES 3.000	S 0.625	R 2.019
depth 0.625	D 11.000	G 1.811	O 22.441	T 3.543
H 0.807	C 44.567	AA 2xNPT 3"	DM NPT 3/4"	

1 2 3 4 5 6 7 8

A

PART-WINDING

WYE-DELTA

START

RUN

START

RUN

B

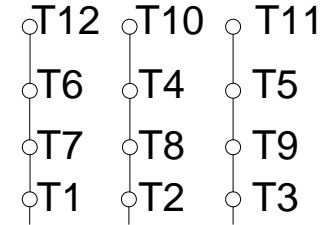
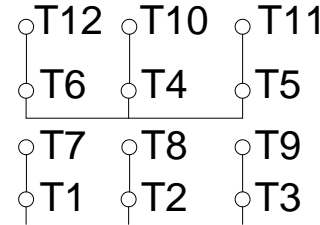
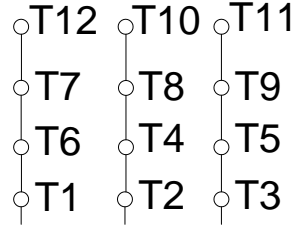
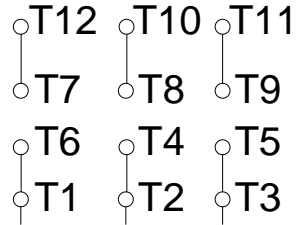

C

L1 L2 L3

L1 L2 L3

L1 L2 L3

L1 L2 L3

D

E

F

Notes: Downloaded from <http://dealerselectric.com>
 Generated for Model #50036OT3G447/9TS

Performed by:

Checked:

Customer:

ODP – Open Induction Motors – NEMA Premium Efficiency

Three-phase induction motor
 Frame 447/9TS - IP23

29-SEP-2016

