



Dealers Industrial Equipment

No.:

Date: 29-SEP-2016

Customer :

TECHNICAL PROPOSAL

Three-phase induction motor - Squirrel cage rotor

Product line : W22 NEMA Premium - Ball Bearings

Catalog Number : 40018ET3G449T-W22

List Price : \$43,805

Notes:

Downloaded from <http://dealerselectric.com>

Generated for Model #40018ET3G449T-W22

Performed by:

Checked:



# Dealers Industrial Equipment

No.:

Date: 29-SEP-2016

## DATA SHEET Three-phase induction motor - Squirrel cage rotor

Customer :  
 Product line : W22 NEMA Premium - Ball Bearings

Frame : L447/9T  
 Output : 400 HP  
 Frequency : 60 Hz  
 Poles : 4  
 Full load speed : 1785 rpm  
 Slip : 0.83 %  
 Voltage : 460 V  
 Rated current : 445 A  
 Locked rotor current : 2890 A  
 Locked rotor current (I<sub>L</sub>/I<sub>n</sub>) : 6.5  
 No-load current : 125 A  
 Full load torque : 1161 lb.ft  
 Locked rotor torque : 250 %  
 Breakdown torque : 260 %  
 Design : B  
 Insulation class : F  
 Temperature rise : 80 K  
 Locked rotor time : 21 s (hot)  
 Service factor : 1.15  
 Duty cycle : S1  
 Ambient temperature : -20°C - +40°C  
 Altitude : 1000 m  
 Degree of Protection : IP55  
 Approximate weight : 3285 lb  
 Moment of inertia : 136.37 sq.ft.lb  
 Noise level : 79 dB(A)

	D.E.	N.D.E.
Bearings	6322 C3	6319 C3
Regreasing interval	6000 h	8000 h
Grease amount	60 g	45 g

Load	Power factor	Efficiency (%)
100%	0.88	96.2
75%	0.85	95.8
50%	0.80	95.4

Notes:  
 Downloaded from <http://dealerselectric.com>  
 Generated for Model #40018ET3G449T-W22

Performed by

Checked



# Dealers Industrial Equipment

No.:

Date: 29-SEP-2016

## PERFORMANCE CURVES RELATED TO RATED OUTPUT

Three-phase induction motor - Squirrel cage rotor

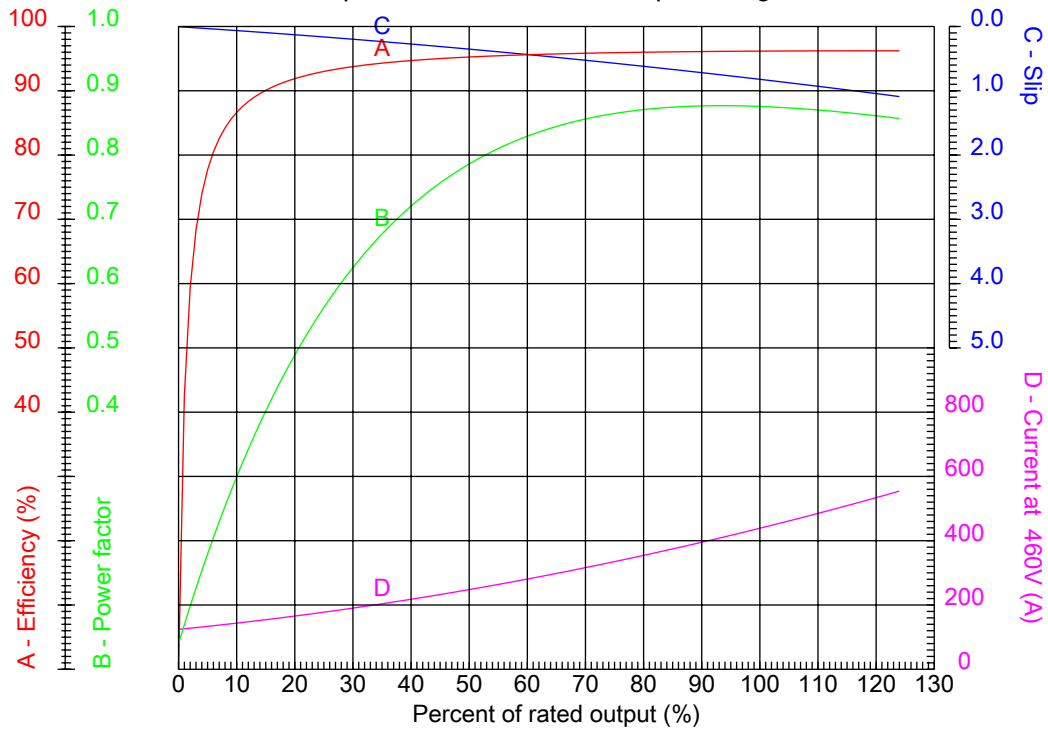

Customer :  
Product line : W22 NEMA Premium - Ball Bearings

Frame : L447/9T	Locked rotor current (I <sub>l</sub> /I <sub>n</sub> ) : 6.5
Output : 400 HP	Duty cycle : S1
Frequency : 60 Hz	Service factor : 1.15
Full load speed : 1785 rpm	Design : B
Voltage : 460 V	Locked rotor torque : 250 %
Rated current : 445 A	Breakdown torque : 260 %
Insulation class : F	

Notes:  
Downloaded from <http://dealerselectric.com>  
Generated for Model #40018ET3G449T-W22

Performed by

Checked



# Dealers Industrial Equipment

No.:

Date: 29-SEP-2016

## CHARACTERISTIC CURVES RELATED TO SPEED

Three-phase induction motor - Squirrel cage rotor

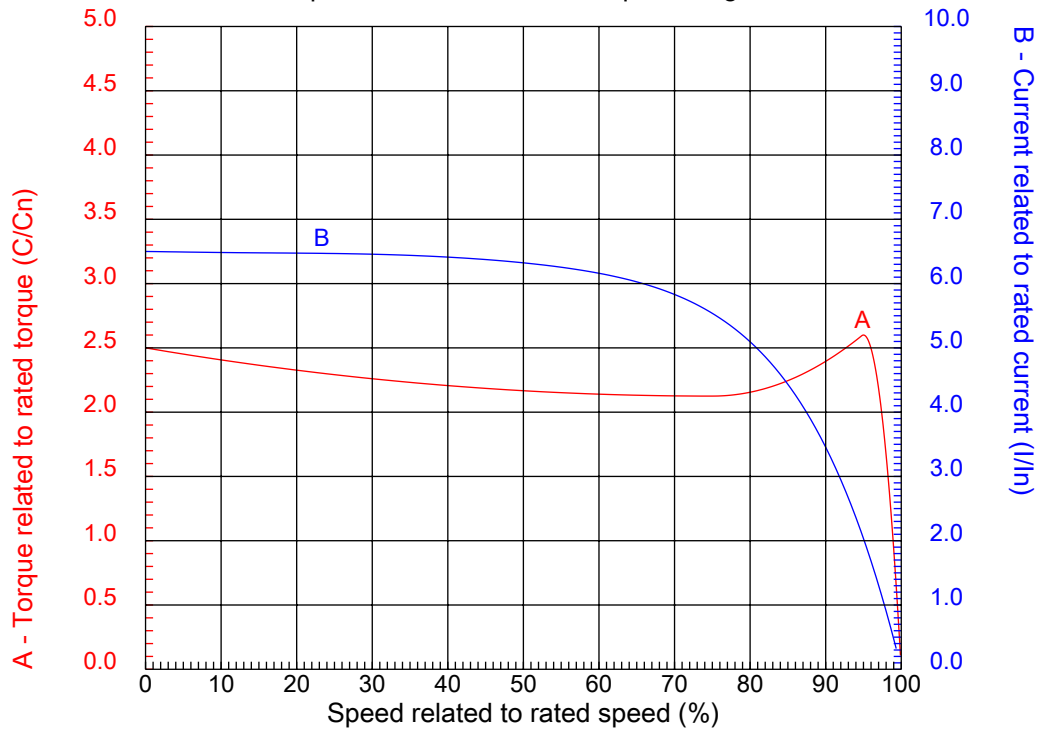

Customer :  
Product line : W22 NEMA Premium - Ball Bearings

Frame	: L447/9T	Locked rotor current (I <sub>l</sub> /I <sub>n</sub> )	: 6.5
Output	: 400 HP	Duty cycle	: S1
Frequency	: 60 Hz	Service factor	: 1.15
Full load speed	: 1785 rpm	Design	: B
Voltage	: 460 V	Locked rotor torque	: 250 %
Rated current	: 445 A	Breakdown torque	: 260 %
Insulation class	: F		

Notes:  
Downloaded from <http://dealerselectric.com>  
Generated for Model #40018ET3G449T-W22

Performed by

Checked

1 2 3 4 5 6 7 8

A

B

C

D

E

F

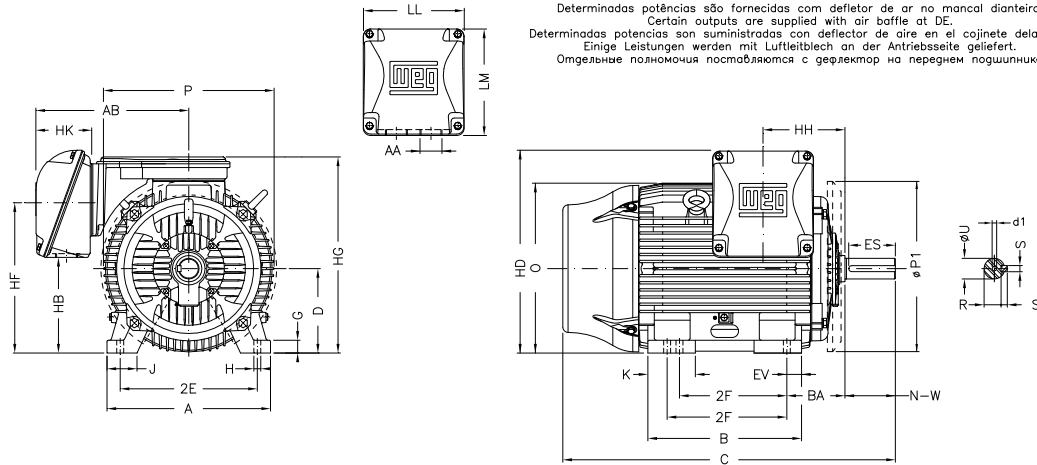

Determinadas potências são fornecidas com defletor de ar no mancal dianteiro.  
 Certain outputs are supplied with air baffle at DE.  
 Determinadas potencias son suministradas con deflector de aire en el cojinete delantero.  
 Einige Leistungen werden mit Luftblech an der Antriebsseite geliefert.  
 Отдельные полнomoчия поставляются с дефлектор на переднем подшипнике.

Notes: Downloaded from <http://dealerselectric.com>  
 Generated for Model #40018ET3G449T-W22

2E 18.000	J 3.937	A 21.929	P 25.866	AB 23.720
2F 20.000/25.000	K 11.688	B 31.535	BA 7.500	U 3.375
N-W 8.500	ES 7.087	S 0.875	R 2.880	depth 0.875
D 11.000	G 1.630	HB 11.535	O 23.874	HD 30.708
HF 20.551	HG 28.185	HH 11.870	HK 8.661	EV 2.638
H 0.810	C 57.181	LL 15.906	LM 17.165	AA 2xNPT 3"
d1 DUNC 3/4"-10				

Performed by:	
Checked:	
Customer:	
W22 NEMA Premium - Ball Bearings	
Three-phase induction motor Frame L447/9T - IP55	29-SEP-2016



1 2 3 4 5 6 7 8

A

### PART-WINDING

### WYE-DELTA

#### START

#### RUN

#### START

#### RUN

B

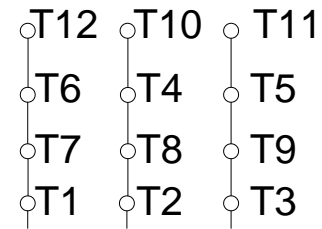
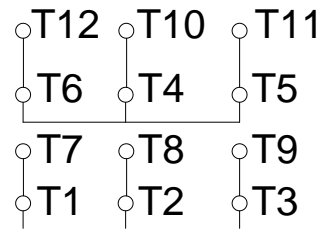
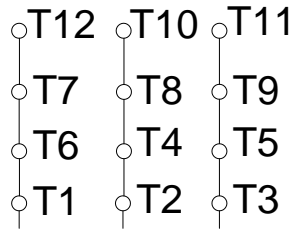
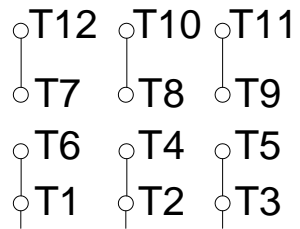

C

L1 L2 L3

L1 L2 L3

L1 L2 L3

L1 L2 L3

D

E

F

Notes: Downloaded from <http://dealerselectric.com>  
 Generated for Model #40018ET3G449T-W22

Performed by:

Checked:

Customer:

W22 NEMA Premium - Ball Bearings

Three-phase induction motor  
 Frame L447/9T - IP55

29-SEP-2016

