



Dealers Industrial Equipment

No.:

Date: 29-SEP-2016

Customer :

TECHNICAL PROPOSAL

Three-phase induction motor - Squirrel cage rotor

Product line : Three-Phase: W22 Crusher Duty TEFC (IP55)

Catalog Number : 40018EP3GKD580Z-W22

List Price : \$43,272

Notes:

Downloaded from <http://dealerselectric.com>

Generated for Model #40018EP3GKD580Z-W22

Performed by:

Checked:



Dealers Industrial Equipment

No.:

Date: 29-SEP-2016

DATA SHEET Three-phase induction motor - Squirrel cage rotor

Customer :
 Product line : Three-Phase: W22 Crusher Duty TEFC (IP55)

Frame : 586/7Z
 Output : 400 HP
 Frequency : 60 Hz
 Poles : 4
 Full load speed : 1790 rpm
 Slip : 0.56 %
 Voltage : 460 V
 Rated current : 452 A
 Locked rotor current : 3250 A
 Locked rotor current (I_L/I_n) : 7.2
 No-load current : 138 A
 Full load torque : 1158 lb.ft
 Locked rotor torque : 210 %
 Breakdown torque : 240 %
 Design : A
 Insulation class : F
 Temperature rise : 80 K
 Locked rotor time : 12 s (hot)
 Service factor : 1.15
 Duty cycle : S1
 Ambient temperature : -20°C - +40°C
 Altitude : 1000 m
 Degree of Protection : IP55
 Approximate weight : 3771 lb
 Moment of inertia : 192.69 sq.ft.lb
 Noise level : 81 dB(A)

	D.E.	N.D.E.
Bearings	NU-324 C3	6319 C3
Regreasing interval	3000 h	8000 h
Grease amount	72 g	45 g

Load	Power factor	Efficiency (%)
100%	0.87	95.8
75%	0.84	95.8
50%	0.77	95.4

Notes:
 Downloaded from <http://dealerselectric.com>
 Generated for Model #40018EP3GKD580Z-W22

Performed by

Checked



Dealers Industrial Equipment

No.:

Date: 29-SEP-2016

PERFORMANCE CURVES RELATED TO RATED OUTPUT

Three-phase induction motor - Squirrel cage rotor

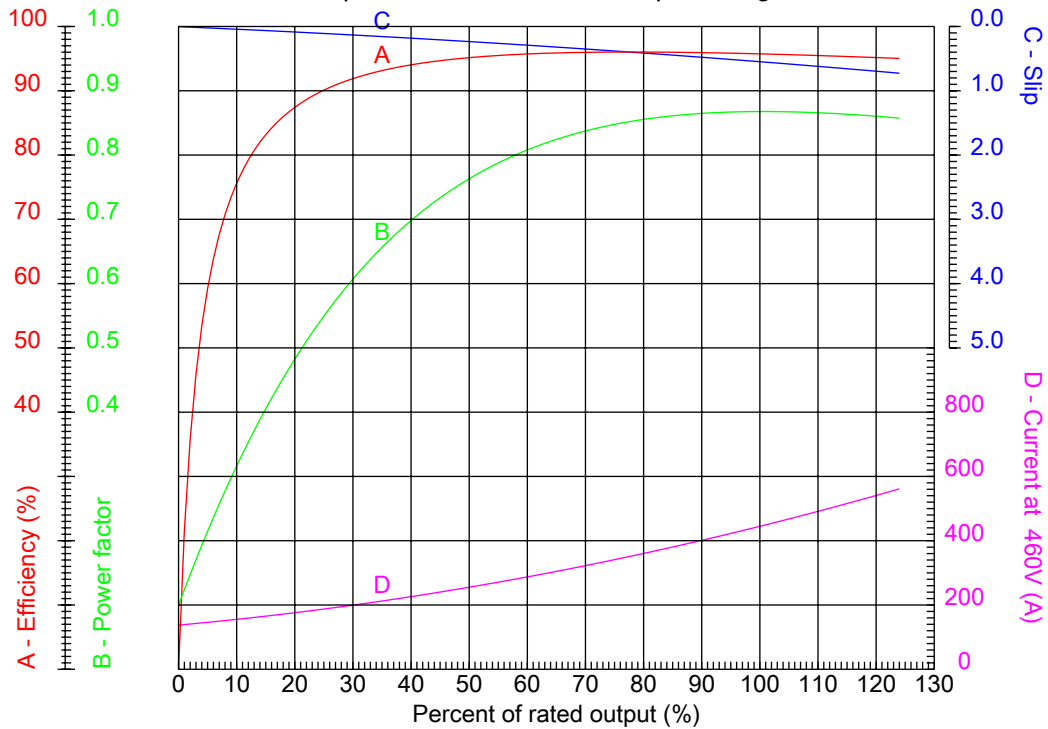

Customer :
Product line : Three-Phase: W22 Crusher Duty TEFC (IP55)

Frame	: 586/7Z	Locked rotor current (I _l /I _n)	: 7.2
Output	: 400 HP	Duty cycle	: S1
Frequency	: 60 Hz	Service factor	: 1.15
Full load speed	: 1790 rpm	Design	: A
Voltage	: 460 V	Locked rotor torque	: 210 %
Rated current	: 452 A	Breakdown torque	: 240 %
Insulation class	: F		

Notes:
Downloaded from <http://dealerselectric.com>
Generated for Model #40018EP3GKD580Z-W22

Performed by

Checked



Dealers Industrial Equipment

No.:

Date: 29-SEP-2016

CHARACTERISTIC CURVES RELATED TO SPEED

Three-phase induction motor - Squirrel cage rotor

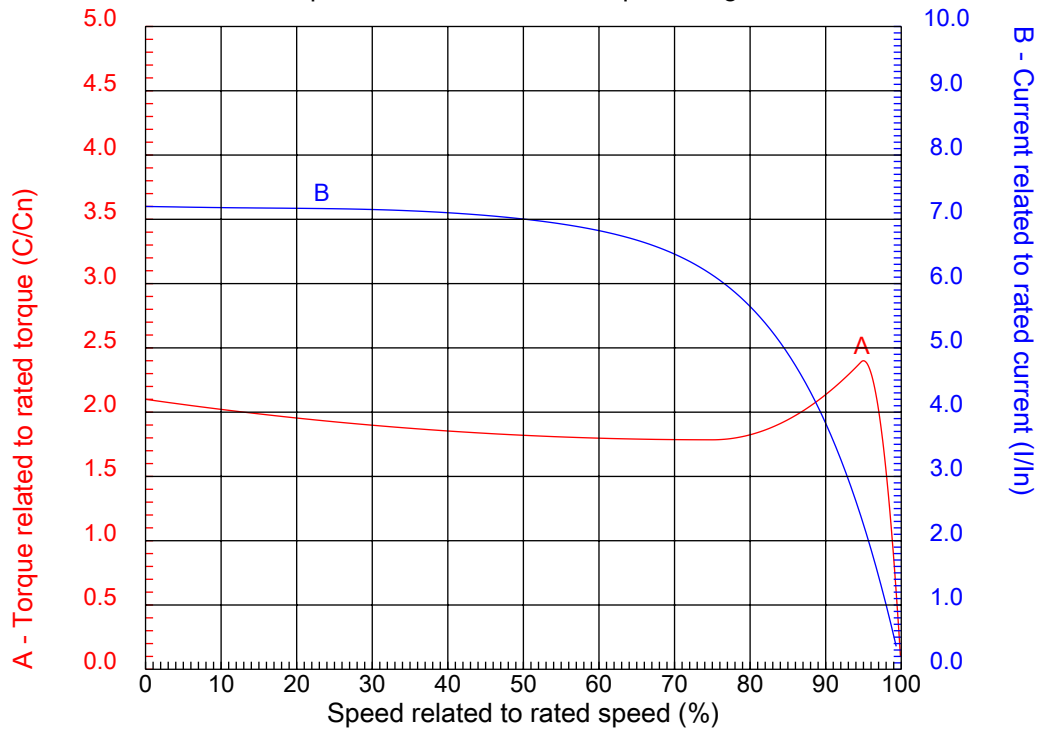

Customer :
Product line : Three-Phase: W22 Crusher Duty TEFC (IP55)

Frame	: 586/7Z	Locked rotor current (I _l /I _n)	: 7.2
Output	: 400 HP	Duty cycle	: S1
Frequency	: 60 Hz	Service factor	: 1.15
Full load speed	: 1790 rpm	Design	: A
Voltage	: 460 V	Locked rotor torque	: 210 %
Rated current	: 452 A	Breakdown torque	: 240 %
Insulation class	: F		

Notes:
Downloaded from <http://dealerselectric.com>
Generated for Model #40018EP3GKD580Z-W22

Performed by

Checked

1 2 3 4 5 6 7 8

A
B
C
D
E
F

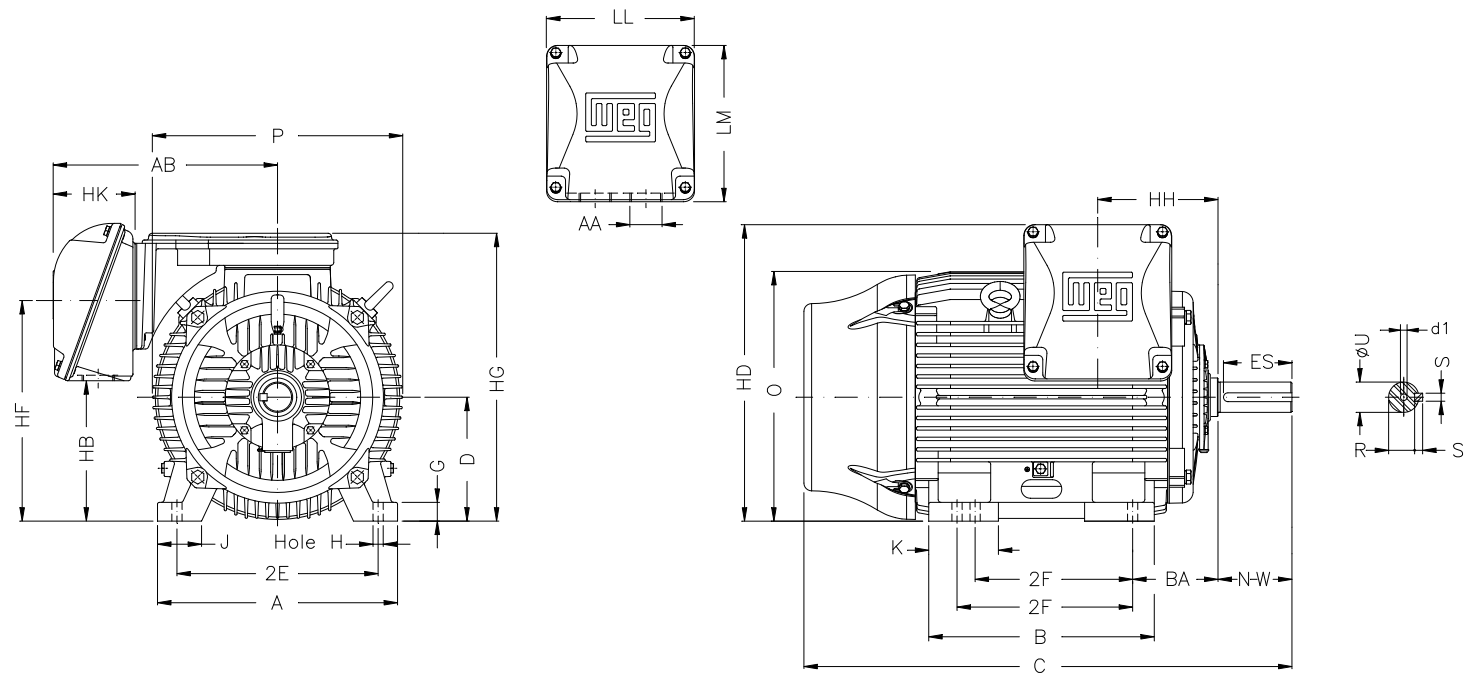

Notes: Downloaded from <http://dealerselectric.com>
Generated for Model #40018EP3GKD580Z-W22

2E 23.000	J 5.512	A 29.528	P 28.977	AB 23.189
2F 22.000/25.000	K 9.055	B 29.921	BA 10.000	U 4.375
N-W 11.625	ES 8.661	S 1.000	R 3.816	depth 1.000
D 14.500	G 2.492	HB 18.575	O 28.985	HD 35.740
HF 26.732	HG 35.236	HH 13.346	HK 8.661	H 1.181
C 61.902	LL 15.906	LM 17.165	AA 2xNPT 3"	d1 DUNC 7/8"-9
d2 DUNC 3/4"-10				

Performed by:	
Checked:	
Customer:	
Three-Phase: W22 Crusher Duty TEFC (IP55)	
Three-phase induction motor Frame 586/7Z - IP55	29-SEP-2016



1 2 3 4 5 6 7 8

A

PART-WINDING

WYE-DELTA

START

RUN

START

RUN

B

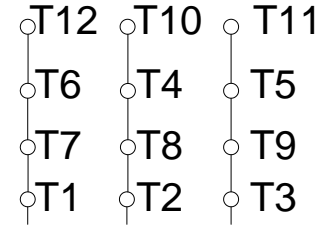
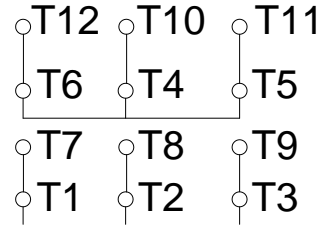
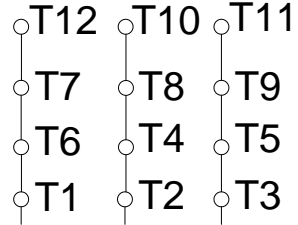
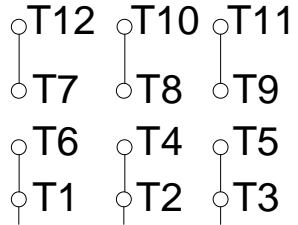

C

L1 L2 L3

L1 L2 L3

L1 L2 L3

L1 L2 L3

D

E

F

Notes: Downloaded from <http://dealerselectric.com>
 Generated for Model #40018EP3GKD580Z-W22

Performed by:

Checked:

Customer:

Three-Phase: W22 Crusher Duty TEFC (IP55)

Three-phase induction motor
 Frame 586/7Z - IP55

29-SEP-2016

