



Dealers Industrial Equipment

No.:

Date: 29-SEP-2016

Customer :

TECHNICAL PROPOSAL

Three-phase induction motor - Squirrel cage rotor

Product line : W22 NEMA Premium - Roller Bearings

Catalog Number : 40012ET3GRB449T-W22

List Price : \$52,307

Notes:

Downloaded from <http://dealerselectric.com>

Generated for Model #40012ET3GRB449T-W22

Performed by:

Checked:



Dealers Industrial Equipment

No.:

Date: 29-SEP-2016

DATA SHEET Three-phase induction motor - Squirrel cage rotor

Customer :
Product line : W22 NEMA Premium - Roller Bearings

Frame : L447/9T
Output : 400 HP
Frequency : 60 Hz
Poles : 6
Full load speed : 1190 rpm
Slip : 0.83 %
Voltage : 460 V
Rated current : 477 A
Locked rotor current : 3290 A
Locked rotor current (I_L/I_n) : 6.9
No-load current : 200 A
Full load torque : 1741 lb.ft
Locked rotor torque : 240 %
Breakdown torque : 250 %
Design : A
Insulation class : F
Temperature rise : 105 K
Locked rotor time : 13 s (hot)
Service factor : 1.15
Duty cycle : S1
Ambient temperature : -20°C - +40°C
Altitude : 1000 m
Degree of Protection : IP55
Approximate weight : 3682 lb
Moment of inertia : 278.34 sq.ft.lb
Noise level : 71 dB(A)

	D.E.	N.D.E.
Bearings	NU-322 C3	6319 C3
Regreasing interval	7000 h	13000 h
Grease amount	60 g	45 g

Load	Power factor	Efficiency (%)
100%	0.82	95.8
75%	0.78	95.8
50%	0.68	95.4

Notes:

Downloaded from <http://dealerselectric.com>
Generated for Model #40012ET3GRB449T-W22

Performed by

Checked



Dealers Industrial Equipment

No.:

Date: 29-SEP-2016

PERFORMANCE CURVES RELATED TO RATED OUTPUT

Three-phase induction motor - Squirrel cage rotor

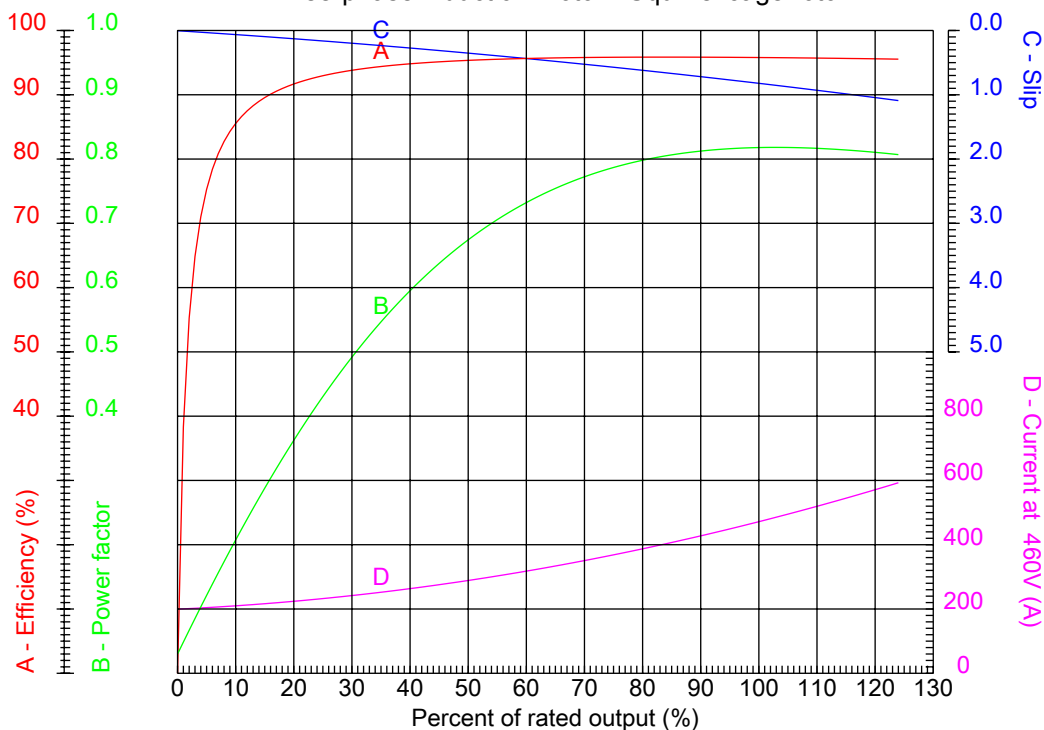

Customer :
Product line : W22 NEMA Premium - Roller Bearings

Frame : L447/9T	Locked rotor current (I _l /I _n) : 6.9
Output : 400 HP	Duty cycle : S1
Frequency : 60 Hz	Service factor : 1.15
Full load speed : 1190 rpm	Design : A
Voltage : 460 V	Locked rotor torque : 240 %
Rated current : 477 A	Breakdown torque : 250 %
Insulation class : F	

Notes:
Downloaded from <http://dealerselectric.com>
Generated for Model #40012ET3GRB449T-W22

Performed by

Checked



Dealers Industrial Equipment

No.:

Date: 29-SEP-2016

CHARACTERISTIC CURVES RELATED TO SPEED

Three-phase induction motor - Squirrel cage rotor

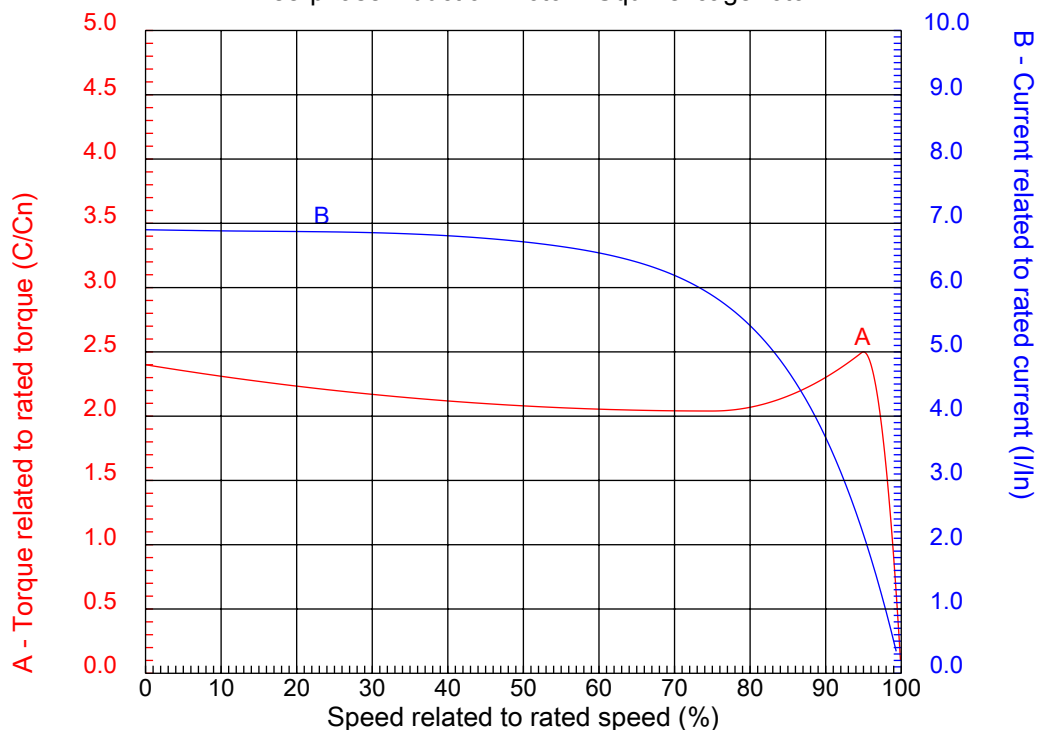

Customer :
Product line : W22 NEMA Premium - Roller Bearings

Frame	: L447/9T	Locked rotor current (I _l /I _n)	: 6.9
Output	: 400 HP	Duty cycle	: S1
Frequency	: 60 Hz	Service factor	: 1.15
Full load speed	: 1190 rpm	Design	: A
Voltage	: 460 V	Locked rotor torque	: 240 %
Rated current	: 477 A	Breakdown torque	: 250 %
Insulation class	: F		

Notes:
Downloaded from <http://dealerselectric.com>
Generated for Model #40012ET3GRB449T-W22

Performed by

Checked

1 2 3 4 5 6 7 8

A

B

C

D

E

F

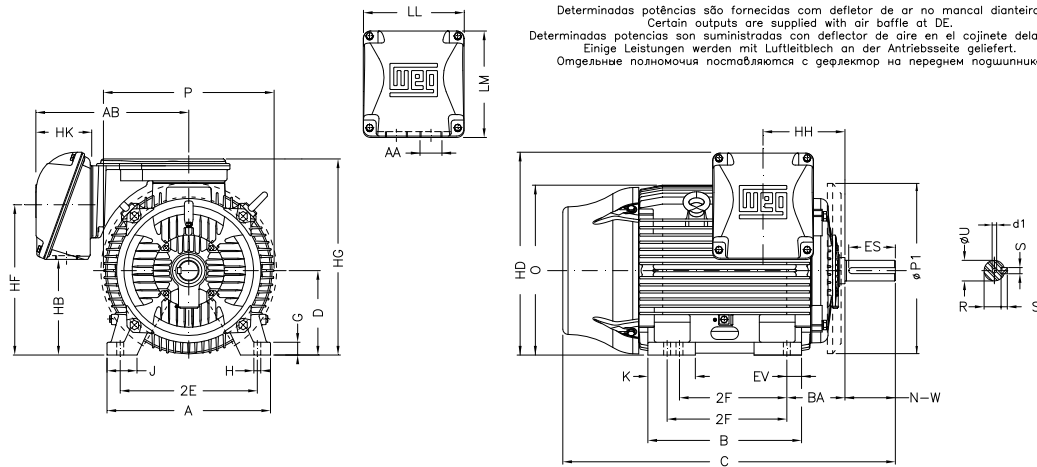

Notes: Downloaded from <http://dealerselectric.com>
 Generated for Model #40012ET3GRB449T-W22

2E 18.000	J 3.937	A 21.929	P 25.866	AB 23.720
2F 20.000/25.000	K 11.688	B 31.535	BA 7.500	U 3.375
N-W 8.500	ES 7.087	S 0.875	R 2.880	depth 0.875
D 11.000	G 1.630	HB 11.535	O 23.874	HD 30.708
HF 20.551	HG 28.185	HH 11.870	HK 8.661	EV 2.638
H 0.810	C 57.181	LL 15.906	LM 17.165	AA 2xNPT 3"
d1 DUNC 3/4"-10				

Performed by:	
Checked:	
Customer:	
W22 NEMA Premium - Roller Bearings	
Three-phase induction motor Frame L447/9T - IP55	29-SEP-2016



1 2 3 4 5 6 7 8

A

PART-WINDING

WYE-DELTA

START

RUN

START

RUN

B

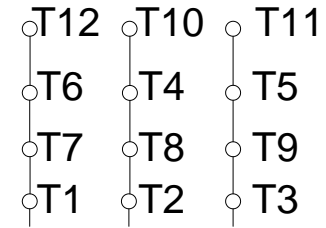
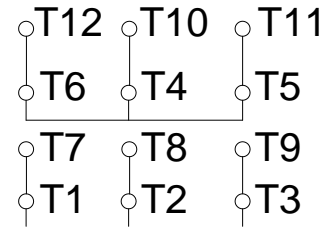
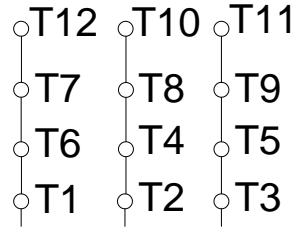
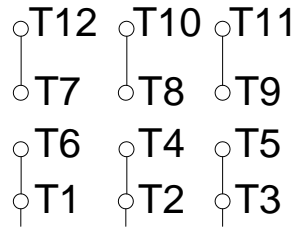

C

L1 L2 L3

L1 L2 L3

L1 L2 L3

L1 L2 L3

D

E

F

Notes: Downloaded from http://dealerselectric.com Generated for Model #40012ET3GRB449T-W22		
Performed by:		
Checked:		
Customer:		
W22 NEMA Premium - Roller Bearings		
Three-phase induction motor Frame L447/9T - IP55	29-SEP-2016	