



Dealers Industrial Equipment

No.:

Date: 29-SEP-2016

Customer :

TECHNICAL PROPOSAL

Three-phase induction motor - Squirrel cage rotor

Product line : W22 High Efficiency
Catalog Number : 35009EP3G586/7-W22
List Price : \$>(discontinued)

Notes:
Downloaded from <http://dealerselectric.com>
Generated for Model #35009EP3G586/7-W22

Performed by:

Checked:



Dealers Industrial Equipment

No.:

Date: 29-SEP-2016

DATA SHEET Three-phase induction motor - Squirrel cage rotor

Customer :
Product line : W22 High Efficiency

Frame : 586/7T
Output : 350 HP
Frequency : 60 Hz
Poles : 8
Full load speed : 895 rpm
Slip : 0.56 %
Voltage : 460 V
Rated current : 424 A
Locked rotor current : 2710 A
Locked rotor current (I_L/I_n) : 6.4
No-load current : 260 A
Full load torque : 2026 lb.ft
Locked rotor torque : 150 %
Breakdown torque : 220 %
Design : B
Insulation class : F
Temperature rise : 80 K
Locked rotor time : 22 s (hot)
Service factor : 1.15
Duty cycle : S1
Ambient temperature : -20°C - +40°C
Altitude : 1000 m
Degree of Protection : IP55
Approximate weight : 4311 lb
Moment of inertia : 484.35 sq.ft.lb
Noise level : 75 dB(A)

	D.E.	N.D.E.
Bearings	6322 C3	6319 C3
Regreasing interval	14000 h	17000 h
Grease amount	60 g	45 g

Load	Power factor	Efficiency (%)
100%	0.81	95.0
75%	0.77	95.4
50%	0.66	94.8

Notes:
Downloaded from <http://dealerselectric.com>
Generated for Model #35009EP3G586/7-W22

Performed by

Checked



Dealers Industrial Equipment

No.:

Date: 29-SEP-2016

PERFORMANCE CURVES RELATED TO RATED OUTPUT

Three-phase induction motor - Squirrel cage rotor

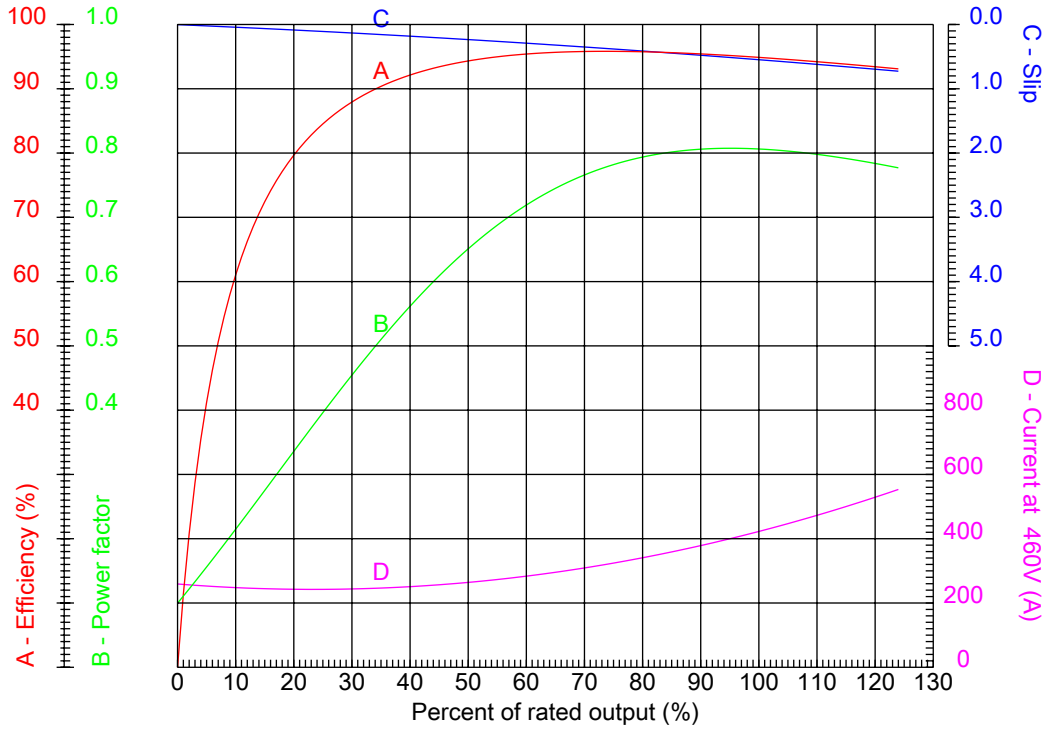

Customer :
 Product line : W22 High Efficiency

Frame	: 586/7T	Locked rotor current (I _l /I _n)	: 6.4
Output	: 350 HP	Duty cycle	: S1
Frequency	: 60 Hz	Service factor	: 1.15
Full load speed	: 895 rpm	Design	: B
Voltage	: 460 V	Locked rotor torque	: 150 %
Rated current	: 424 A	Breakdown torque	: 220 %
Insulation class	: F		

Notes:
 Downloaded from <http://dealerselectric.com>
 Generated for Model #35009EP3G586/7-W22

Performed by

Checked



CHARACTERISTIC CURVES RELATED TO SPEED

Three-phase induction motor - Squirrel cage rotor

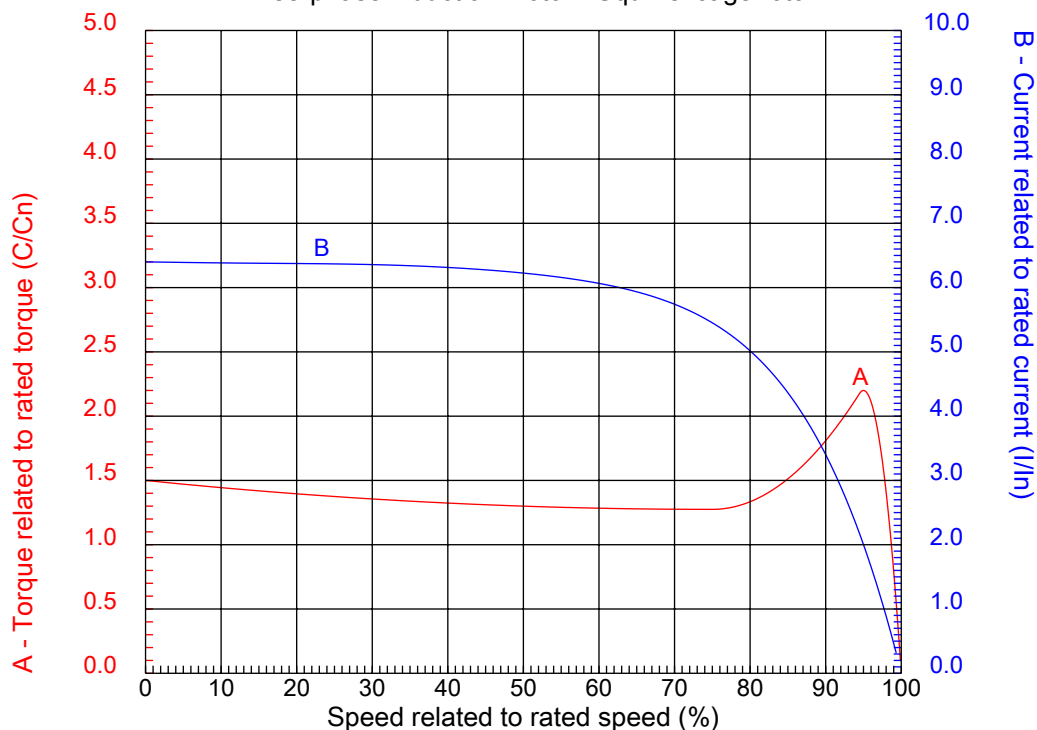

Customer :
Product line : W22 High Efficiency

Frame	: 586/7T	Locked rotor current (I _l /I _n)	: 6.4
Output	: 350 HP	Duty cycle	: S1
Frequency	: 60 Hz	Service factor	: 1.15
Full load speed	: 895 rpm	Design	: B
Voltage	: 460 V	Locked rotor torque	: 150 %
Rated current	: 424 A	Breakdown torque	: 220 %
Insulation class	: F		

Notes:
Downloaded from <http://dealerselectric.com>
Generated for Model #35009EP3G586/7-W22

Performed by

Checked

1 2 3 4 5 6 7 8

A

B

C

D

E

F

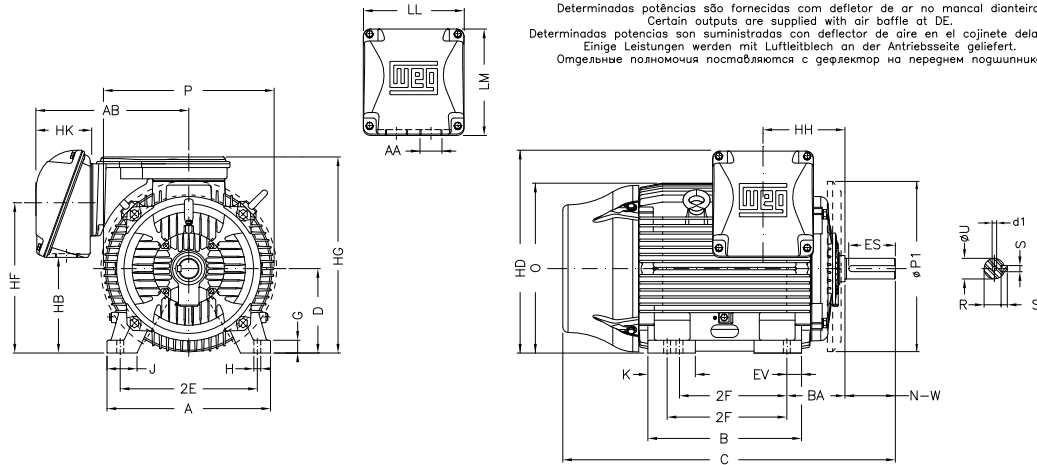

Determinadas potências são fornecidas com defletor de ar no mancal dianteiro.
 Certain outputs are supplied with air baffle at DE.
 Determinadas potencias son suministradas con deflector de aire en el cojinete delantero.
 Einige Leistungen werden mit Luftblech an der Antriebsseite geliefert.
 Отдельные полнomoчия поставляются с дефлектор на переднем подшипнике.

Notes: Downloaded from <http://dealerselectric.com>
 Generated for Model #35009EP3G586/7-W22

Performed by:

Checked:

Customer:

W22 High Efficiency

Three-phase induction motor
 Frame 586/7T - IP55

29-SEP-2016



2E 23.000	J 5.512	A 29.528	P 28.977	AB 23.189
2F 22.000/25.000	K 9.055	B 29.921	BA 10.000	U 3.875
N-W 11.625	ES 8.661	S 1.000	R 3.312	depth 1.000
D 14.500	G 2.492	HB 18.575	O 28.985	HD 35.740
HF 26.732	HG 35.236	HH 13.346	HK 8.661	H 1.181
C 61.902	LL 15.906	LM 17.165	AA 2xNPT 3"	d1 DUNC 7/8"-9

1 2 3 4 5 6 7 8

A

PART-WINDING

WYE-DELTA

START

RUN

START

RUN

B

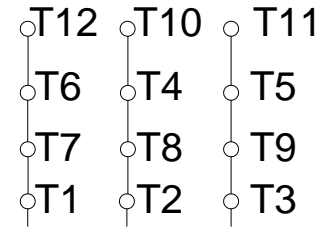
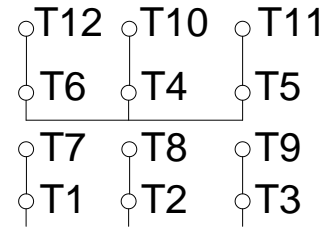
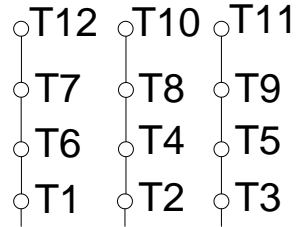
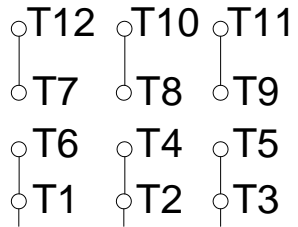

C

L1 L2 L3

L1 L2 L3

L1 L2 L3

L1 L2 L3

D

E

F

Notes: Downloaded from <http://dealerselectric.com>
 Generated for Model #35009EP3G586/7-W22

Performed by:

Checked:

Customer:

W22 High Efficiency

Three-phase induction motor
Frame 586/7T - IP55

29-SEP-2016

