



Dealers Industrial Equipment

No.:

Date: 29-SEP-2016

Customer :

TECHNICAL PROPOSAL

Three-phase induction motor - Squirrel cage rotor

Product line : W22 High Efficiency
Catalog Number : 30036EP3G449TS-W22
List Price : \$>(discontinued)

Notes:
Downloaded from <http://dealerselectric.com>
Generated for Model #30036EP3G449TS-W22

Performed by:

Checked:



Dealers Industrial Equipment

No.:

Date: 29-SEP-2016

DATA SHEET Three-phase induction motor - Squirrel cage rotor

Customer :
Product line : W22 High Efficiency

Frame : 447/9TS
Output : 300 HP
Frequency : 60 Hz
Poles : 2
Full load speed : 3575 rpm
Slip : 0.69 %
Voltage : 460 V
Rated current : 322 A
Locked rotor current : 2090 A
Locked rotor current (I_L/I_n) : 6.5
No-load current : 65.0 A
Full load torque : 435 lb.ft
Locked rotor torque : 250 %
Breakdown torque : 240 %
Design : B
Insulation class : F
Temperature rise : 80 K
Locked rotor time : 14 s (hot)
Service factor : 1.15
Duty cycle : S1
Ambient temperature : -20°C - +40°C
Altitude : 1000 m
Degree of Protection : IP55
Approximate weight : 2545 lb
Moment of inertia : 58.080 sq.ft.lb
Noise level : 81 dB(A)

	D.E.	N.D.E.
Bearings	6314 C3	6314 C3
Regreasing interval	4000 h	4000 h
Grease amount	27 g	27 g

Load	Power factor	Efficiency (%)
100%	0.90	95.4
75%	0.89	95.4
50%	0.86	95.4

Notes:
Downloaded from <http://dealerselectric.com>
Generated for Model #30036EP3G449TS-W22

Performed by

Checked



Dealers Industrial Equipment

No.:

Date: 29-SEP-2016

PERFORMANCE CURVES RELATED TO RATED OUTPUT

Three-phase induction motor - Squirrel cage rotor

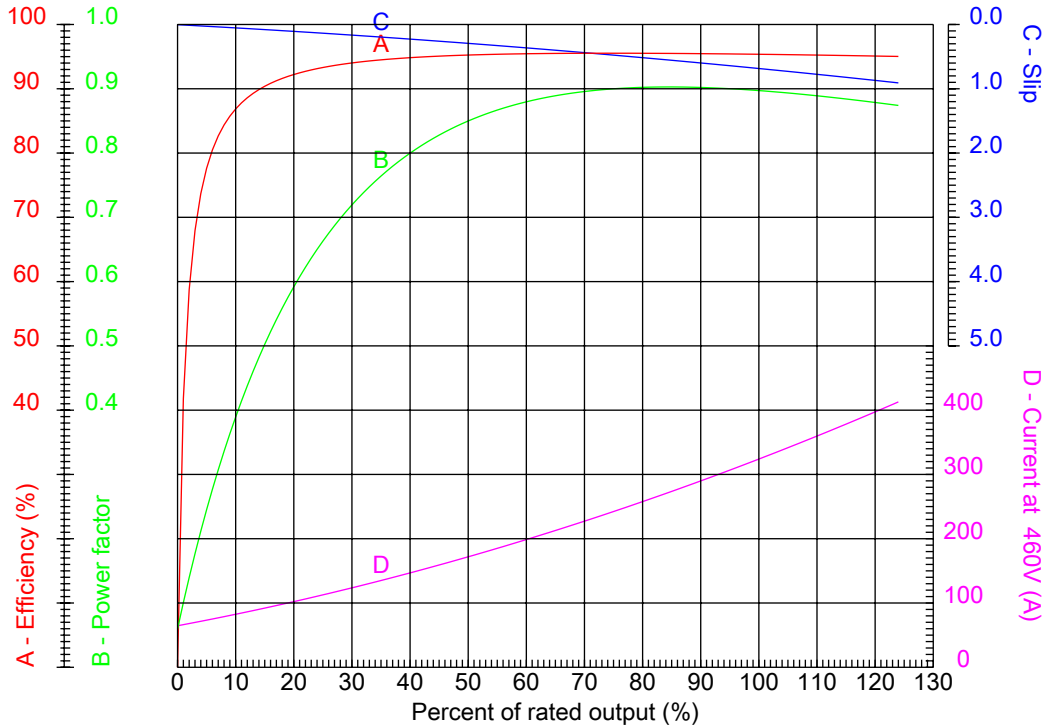

Customer :
Product line : W22 High Efficiency

Frame	: 447/9TS	Locked rotor current (I _l /I _n)	: 6.5
Output	: 300 HP	Duty cycle	: S1
Frequency	: 60 Hz	Service factor	: 1.15
Full load speed	: 3575 rpm	Design	: B
Voltage	: 460 V	Locked rotor torque	: 250 %
Rated current	: 322 A	Breakdown torque	: 240 %
Insulation class	: F		

Notes:
Downloaded from <http://dealerselectric.com>
Generated for Model #30036EP3G449TS-W22

Performed by

Checked



CHARACTERISTIC CURVES RELATED TO SPEED

Three-phase induction motor - Squirrel cage rotor

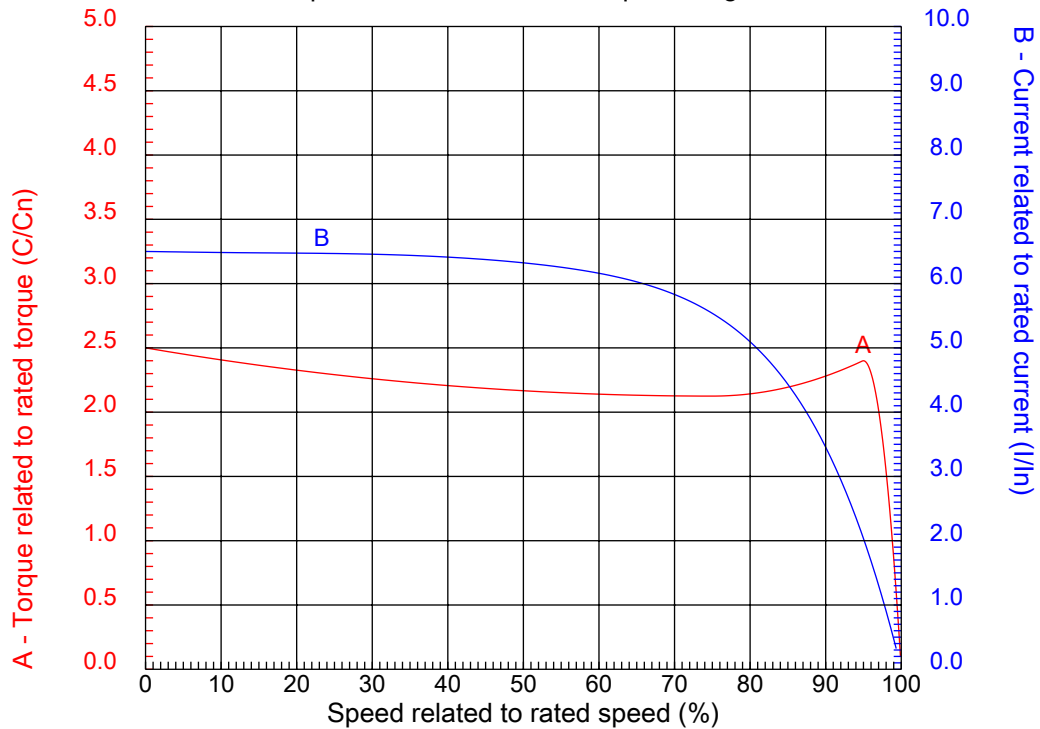

Customer :
Product line : W22 High Efficiency

Frame	: 447/9TS	Locked rotor current (I _l /I _n)	: 6.5
Output	: 300 HP	Duty cycle	: S1
Frequency	: 60 Hz	Service factor	: 1.15
Full load speed	: 3575 rpm	Design	: B
Voltage	: 460 V	Locked rotor torque	: 250 %
Rated current	: 322 A	Breakdown torque	: 240 %
Insulation class	: F		

Notes:
Downloaded from <http://dealerselectric.com>
Generated for Model #30036EP3G449TS-W22

Performed by

Checked

1 2 3 4 5 6 7 8

A

B

C

D

E

F

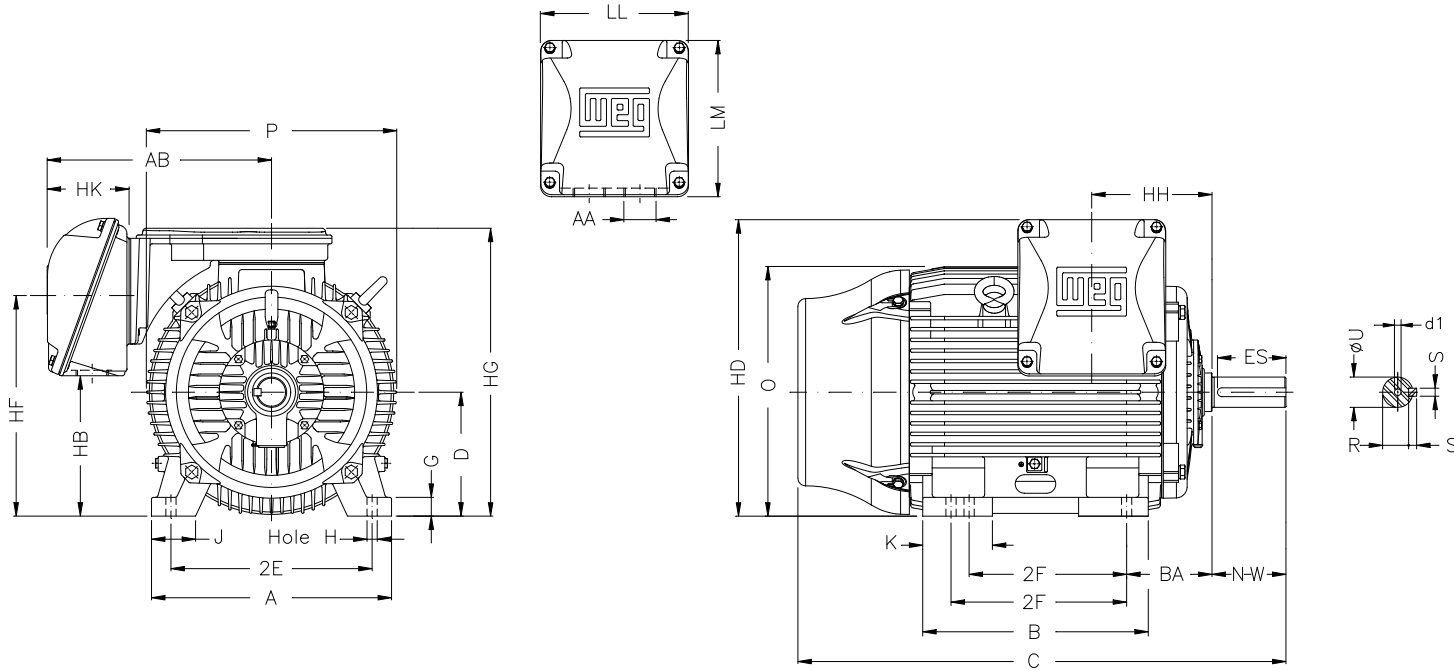

Notes: Downloaded from <http://dealerselectric.com>
Generated for Model #30036EP3G449TS-W22

Performed by:

Checked:

Customer:

W22 High Efficiency

Three-phase induction motor
Frame 447/9TS - IP55

29-SEP-2016



2E 18.000	J 3.937	A 21.929	P 23.583	AB 20.559
2F 20.000/25.000	K 11.772	B 31.535	BA 7.500	U 2.375
N-W 4.750	ES 3.000	S 0.625	R 2.021	depth 0.625
D 11.000	G 1.630	HB 12.488	O 22.795	HD 27.527
HF 20.724	HG 26.830	HH 11.811	HK 6.929	H 0.810
C 52.588	LL 14.921	LM 15.039	AA 2xNPT 3"	d1 DUNC 3/4"-10

1 2 3 4 5 6 7 8

A

PART-WINDING

WYE-DELTA

START

RUN

START

RUN

B

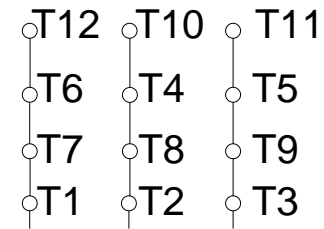
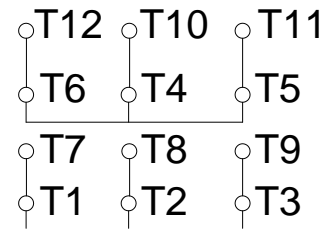
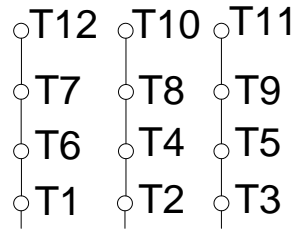
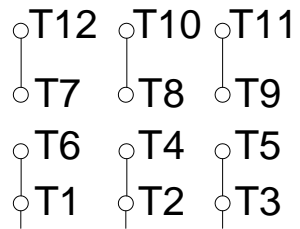

C

L1 L2 L3

L1 L2 L3

L1 L2 L3

L1 L2 L3

D

E

F

Notes: Downloaded from http://dealerselectric.com Generated for Model #30036EP3G449TS-W22		
Performed by:		
Checked:		
Customer:		
W22 High Efficiency		
Three-phase induction motor Frame 447/9TS - IP55	29-SEP-2016	