



Dealers Industrial Equipment

No.:

Date: 28-SEP-2016

Customer :

TECHNICAL PROPOSAL

Three-phase induction motor - Squirrel cage rotor

Product line : ODP – Open Induction Motors – High Efficiency

Catalog Number : 25018OP3G445T

List Price : \$13,358

Notes:

Downloaded from <http://dealerselectric.com>

Generated for Model #25018OP3G445T

Performed by:

Checked:



Dealers Industrial Equipment

No.:

Date: 28-SEP-2016

DATA SHEET Three-phase induction motor - Squirrel cage rotor

Customer :
 Product line : ODP – Open Induction Motors – High Efficiency

Frame : 445T
 Output : 250 HP
 Frequency : 60 Hz
 Poles : 4
 Full load speed : 1780 rpm
 Slip : 1.11 %
 Voltage : 460 V
 Rated current : 273 A
 Locked rotor current : 1800 A
 Locked rotor current (I_L/I_n) : 6.6
 No-load current : 76.0 A
 Full load torque : 728 lb.ft
 Locked rotor torque : 200 %
 Breakdown torque : 230 %
 Design : B
 Insulation class : F
 Temperature rise : 80 K
 Locked rotor time : 15 s (hot)
 Service factor : 1.15
 Duty cycle : S1
 Ambient temperature : -20°C - +40°C
 Altitude : 1000 m
 Degree of Protection : IP23
 Approximate weight : 1786 lb
 Moment of inertia : 53.352 sq.ft.lb
 Noise level : 79 dB(A)

	D.E.	N.D.E.
Bearings	6319 C3	6316 C3
Regreasing interval	20000 h	20000 h
Grease amount	45 g	34 g

Load	Power factor	Efficiency (%)
100%	0.88	95.4
75%	0.86	95.4
50%	0.80	95.0

Notes:
 Downloaded from <http://dealerselectric.com>
 Generated for Model #25018OP3G445T

Performed by

Checked



Dealers Industrial Equipment

No.:

Date: 28-SEP-2016

PERFORMANCE CURVES RELATED TO RATED OUTPUT

Three-phase induction motor - Squirrel cage rotor

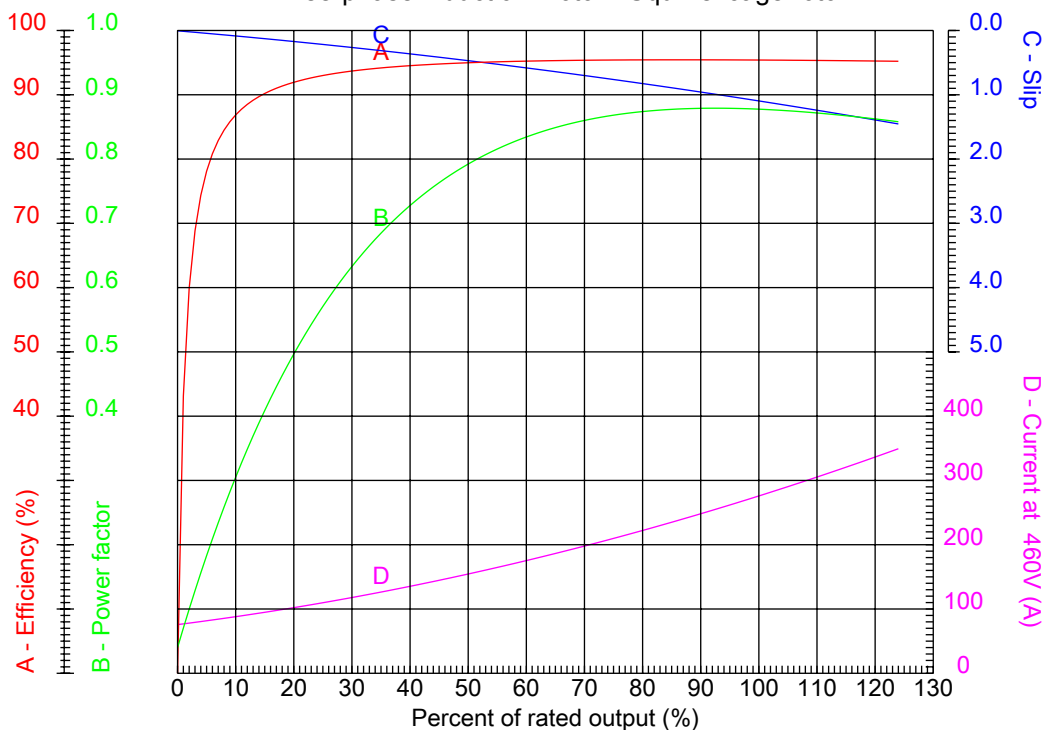

Customer :
Product line : ODP – Open Induction Motors – High Efficiency

Frame	: 445T	Locked rotor current (I _l /I _n)	: 6.6
Output	: 250 HP	Duty cycle	: S1
Frequency	: 60 Hz	Service factor	: 1.15
Full load speed	: 1780 rpm	Design	: B
Voltage	: 460 V	Locked rotor torque	: 200 %
Rated current	: 273 A	Breakdown torque	: 230 %
Insulation class	: F		

Notes:
Downloaded from <http://dealerselectric.com>
Generated for Model #25018OP3G445T

Performed by

Checked



Dealers Industrial Equipment

No.:

Date: 28-SEP-2016

CHARACTERISTIC CURVES RELATED TO SPEED

Three-phase induction motor - Squirrel cage rotor

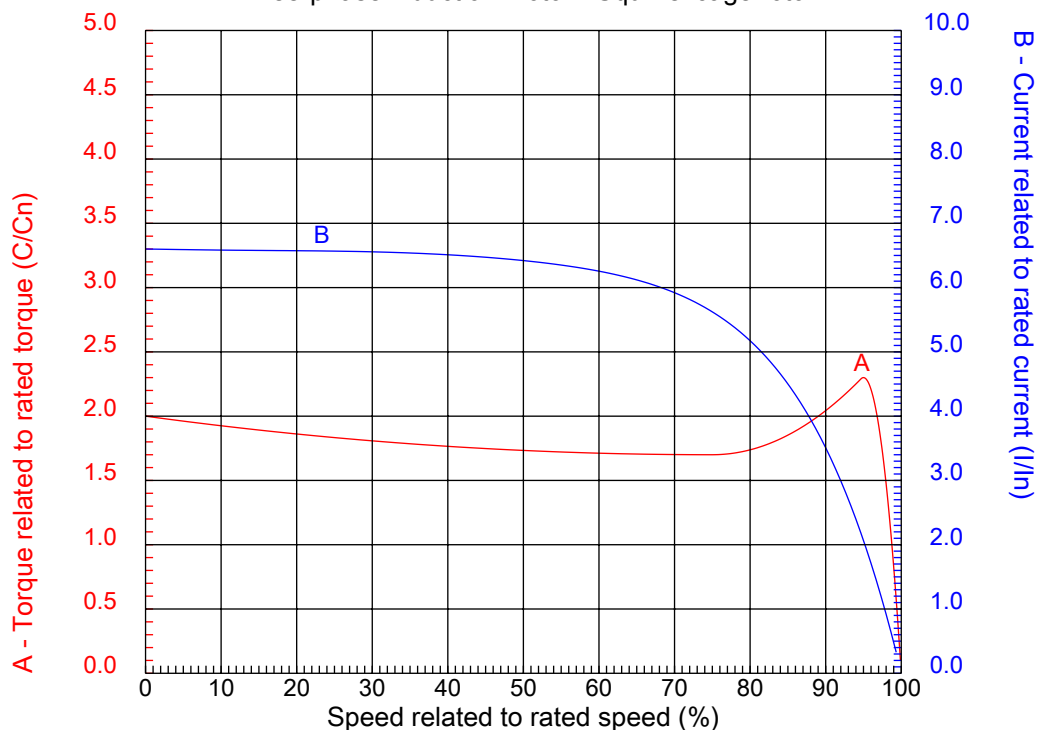

Customer :
Product line : ODP – Open Induction Motors – High Efficiency

Frame	: 445T	Locked rotor current (I _l /I _n)	: 6.6
Output	: 250 HP	Duty cycle	: S1
Frequency	: 60 Hz	Service factor	: 1.15
Full load speed	: 1780 rpm	Design	: B
Voltage	: 460 V	Locked rotor torque	: 200 %
Rated current	: 273 A	Breakdown torque	: 230 %
Insulation class	: F		

Notes:
Downloaded from <http://dealerselectric.com>
Generated for Model #25018OP3G445T

Performed by

Checked

1 2 3 4 5 6 7 8

A

B

C

D

E

F

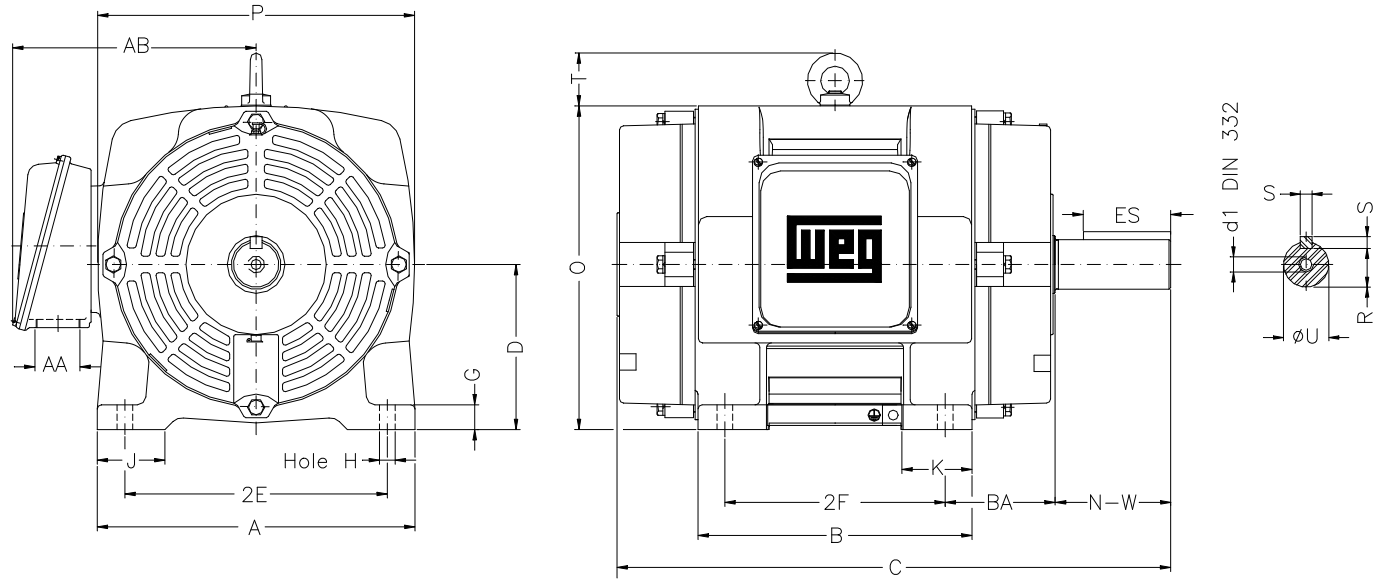

Notes: Downloaded from <http://dealerselectric.com>
Generated for Model #25018OP3G445T

Performed by:

Checked:

Customer:

ODP – Open Induction Motors – High Efficiency

Three-phase induction motor
Frame 445T - IP23

28-SEP-2016



2E 18.000	A 21.929	2F 14.500/16.500	B 20.078	BA 7.500
J 3.937	K 5.590	P 22.125	ES 7.087	depth 0.875
S 0.875	D 11.000	N-W 8.500	G 1.811	U 3.375
O 22.440	T 3.544	R 2.880	H 0.807	AB 20.236
C 39.803	AA 2xNPT 3"	d1 DUNC 3/4"-10		

1 2 3 4 5 6 7 8

A

PART-WINDING

WYE-DELTA

START

RUN

START

RUN

B

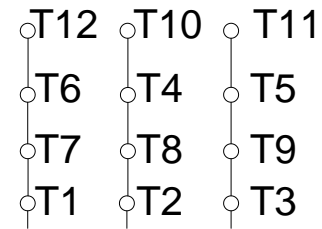
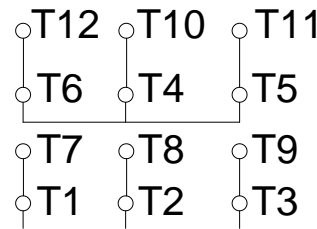
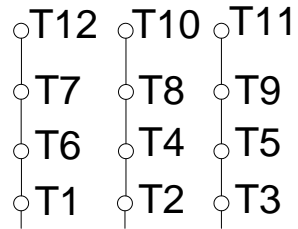
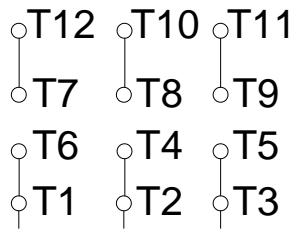

C

L1 L2 L3

L1 L2 L3

L1 L2 L3

L1 L2 L3

D

E

F

Notes: Downloaded from http://dealerselectric.com Generated for Model #25018OP3G445T		
Performed by:		
Checked:		
Customer:		
ODP – Open Induction Motors – High Efficiency		
Three-phase induction motor Frame 445T - IP23	28-SEP-2016	