



# Dealers Industrial Equipment

No.:

Date: 28-SEP-2016

Customer :

## TECHNICAL PROPOSAL

### Three-phase induction motor - Squirrel cage rotor

Product line : Three-Phase: W22 Crusher Duty TEFC (IP55)

Catalog Number : 25012EP3GKD449-W22

List Price : \$28,784

#### Notes:

Downloaded from <http://dealerselectric.com>

Generated for Model #25012EP3GKD449-W22

Performed by:

Checked:



# Dealers Industrial Equipment

No.:

Date: 28-SEP-2016

## DATA SHEET Three-phase induction motor - Squirrel cage rotor

Customer :  
 Product line : Three-Phase: W22 Crusher Duty TEFC (IP55)

Frame : 447/9T  
 Output : 250 HP  
 Frequency : 60 Hz  
 Poles : 6  
 Full load speed : 1190 rpm  
 Slip : 0.83 %  
 Voltage : 460 V  
 Rated current : 300 A  
 Locked rotor current : 2190 A  
 Locked rotor current (I<sub>L</sub>/I<sub>n</sub>) : 7.3  
 No-load current : 136 A  
 Full load torque : 1088 lb.ft  
 Locked rotor torque : 250 %  
 Breakdown torque : 280 %  
 Design : A  
 Insulation class : F  
 Temperature rise : 80 K  
 Locked rotor time : 15 s (hot)  
 Service factor : 1.15  
 Duty cycle : S1  
 Ambient temperature : -20°C - +40°C  
 Altitude : 1000 m  
 Degree of Protection : IP55  
 Approximate weight : 2977 lb  
 Moment of inertia : 152.70 sq.ft.lb  
 Noise level : 70 dB(A)

	D.E.	N.D.E.
Bearings	NU-322 C3	6319 C3
Regreasing interval	7000 h	13000 h
Grease amount	60 g	45 g

Load	Power factor	Efficiency (%)
100%	0.81	95.4
75%	0.75	95.4
50%	0.64	95.0

Notes:  
 Downloaded from <http://dealerselectric.com>  
 Generated for Model #25012EP3GKD449-W22

Performed by

Checked



# Dealers Industrial Equipment

No.:

Date: 28-SEP-2016

## PERFORMANCE CURVES RELATED TO RATED OUTPUT

Three-phase induction motor - Squirrel cage rotor

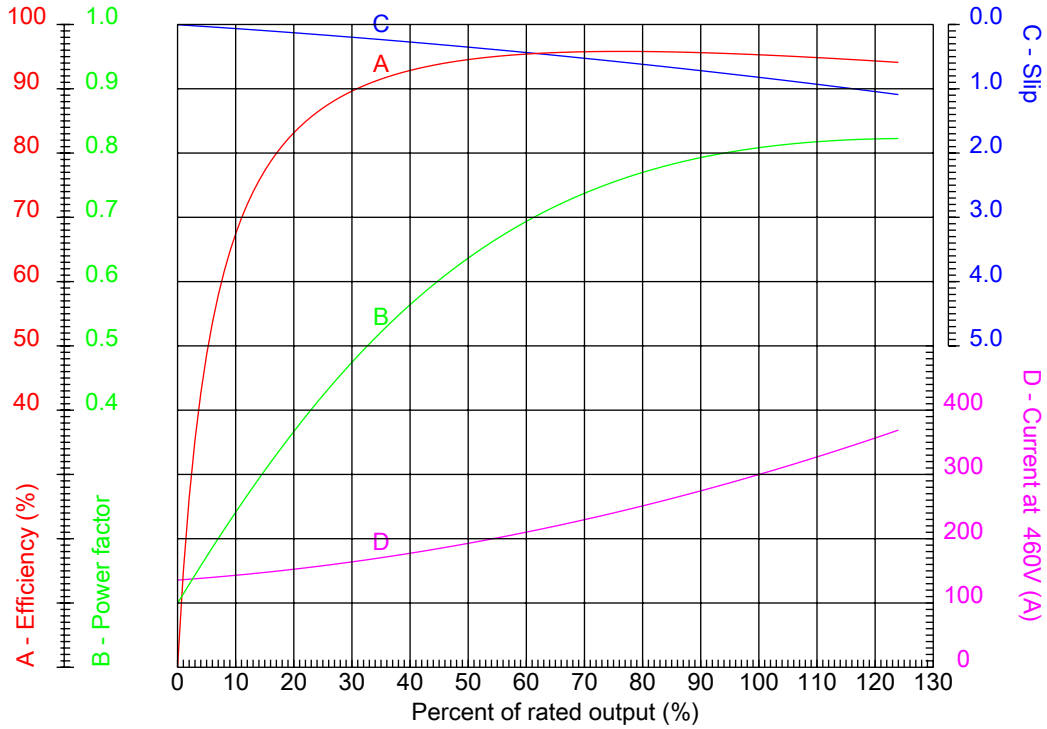

Customer :  
 Product line : Three-Phase: W22 Crusher Duty TEFC (IP55)

Frame	: 447/9T	Locked rotor current (I <sub>l</sub> /I <sub>n</sub> )	: 7.3
Output	: 250 HP	Duty cycle	: S1
Frequency	: 60 Hz	Service factor	: 1.15
Full load speed	: 1190 rpm	Design	: A
Voltage	: 460 V	Locked rotor torque	: 250 %
Rated current	: 300 A	Breakdown torque	: 280 %
Insulation class	: F		

Notes:  
 Downloaded from <http://dealerselectric.com>  
 Generated for Model #25012EP3GKD449-W22

Performed by

Checked



## CHARACTERISTIC CURVES RELATED TO SPEED

Three-phase induction motor - Squirrel cage rotor

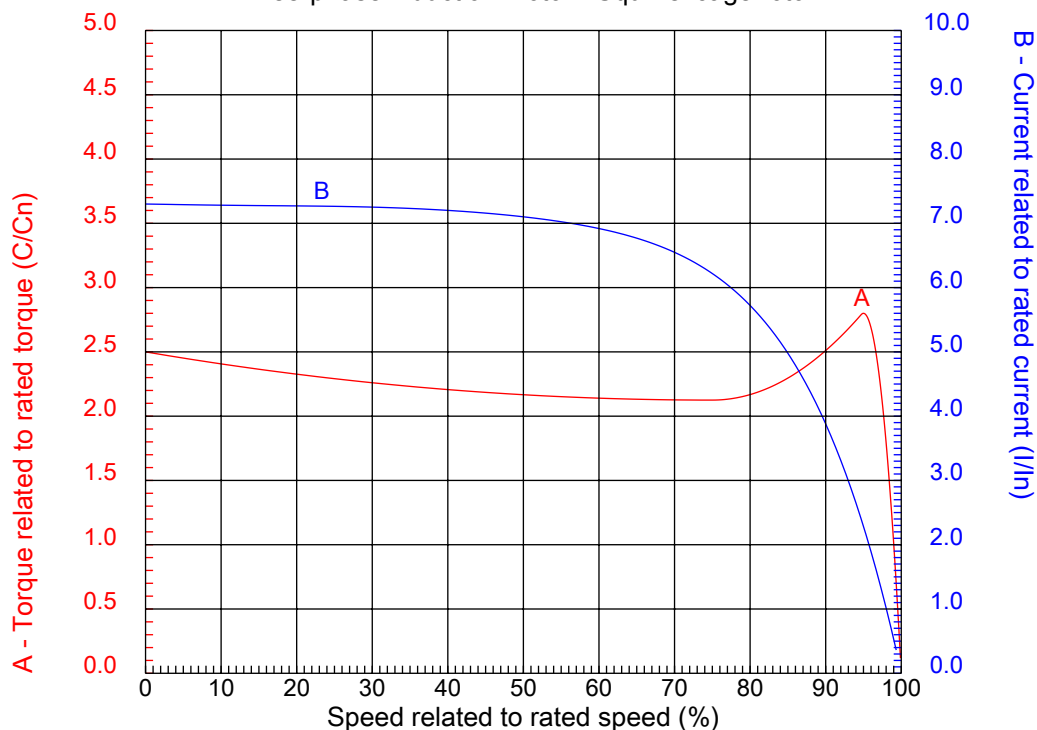

Customer :  
Product line : Three-Phase: W22 Crusher Duty TEFC (IP55)

Frame	: 447/9T	Locked rotor current (I <sub>l</sub> /I <sub>n</sub> )	: 7.3
Output	: 250 HP	Duty cycle	: S1
Frequency	: 60 Hz	Service factor	: 1.15
Full load speed	: 1190 rpm	Design	: A
Voltage	: 460 V	Locked rotor torque	: 250 %
Rated current	: 300 A	Breakdown torque	: 280 %
Insulation class	: F		

Notes:  
Downloaded from <http://dealerselectric.com>  
Generated for Model #25012EP3GKD449-W22

Performed by

Checked

1 2 3 4 5 6 7 8

A

B

C

D

E

F

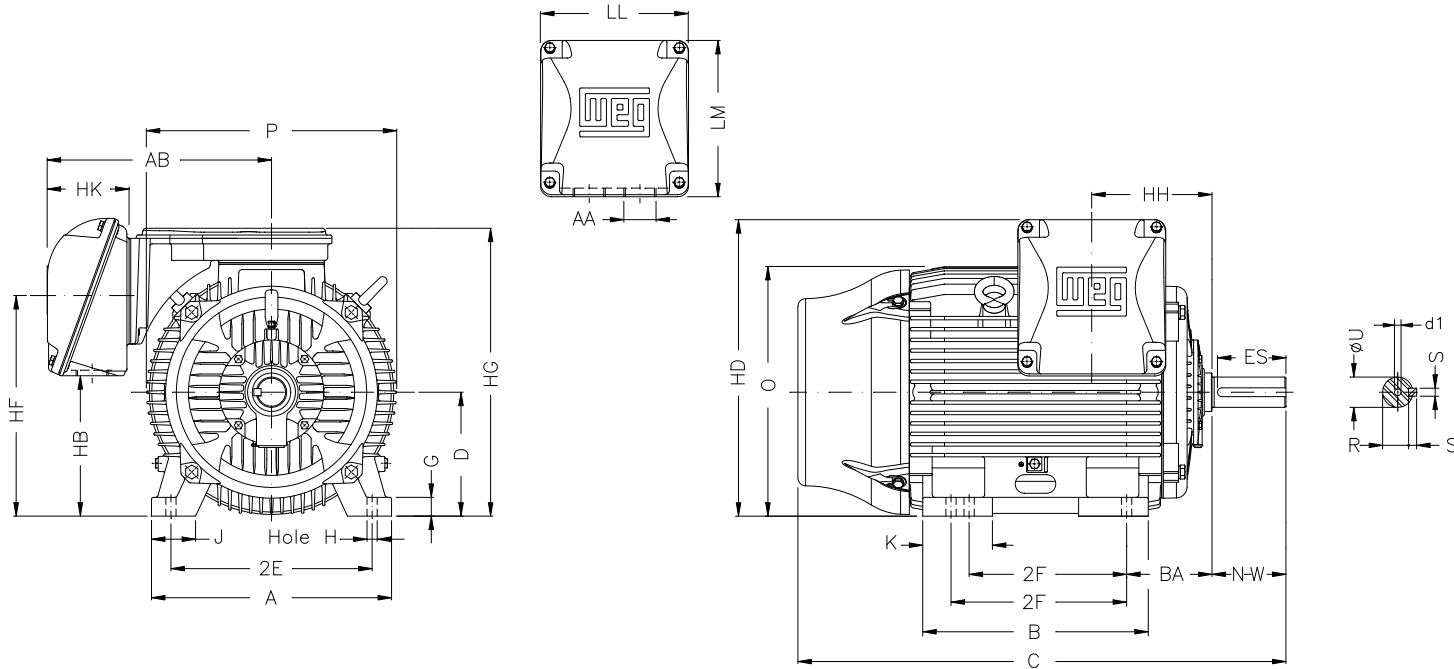

Notes: Downloaded from <http://dealerselectric.com>  
Generated for Model #25012EP3GKD449-W22

2E 18.000	J 3.937	A 21.929	P 23.583	AB 20.559
2F 20.000/25.000	K 11.772	B 31.535	BA 7.500	U 3.375
N-W 8.500	ES 7.087	S 0.875	R 2.880	depth 0.875
D 11.000	G 1.630	HB 12.488	O 22.795	HD 27.527
HF 20.724	HG 26.830	HH 11.811	HK 6.929	H 0.810
C 56.338	LL 14.921	LM 15.039	AA 2xNPT 3"	d1 DUNC 3/4"-10
d2 DUNC 3/4"-10				

Performed by:

Checked:

Customer:

Three-Phase: W22 Crusher Duty TEFC (IP55)

Three-phase induction motor  
Frame 447/9T - IP55

28-SEP-2016



1 2 3 4 5 6 7 8

A

### PART-WINDING

### WYE-DELTA

#### START

#### RUN

#### START

#### RUN

B

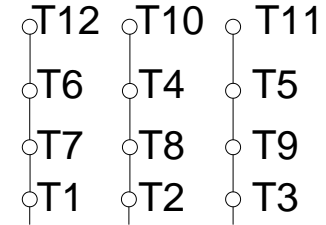
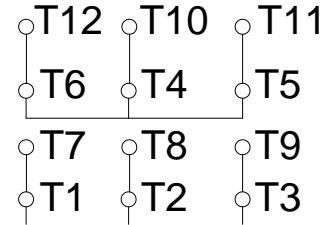
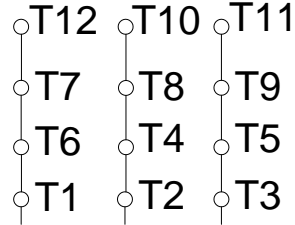
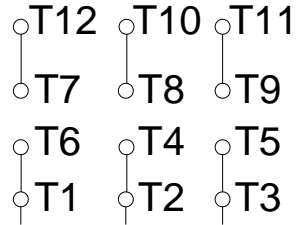

C

L1 L2 L3

L1 L2 L3

L1 L2 L3

L1 L2 L3

D

E

F

Notes: Downloaded from <a href="http://dealerselectric.com">http://dealerselectric.com</a> Generated for Model #25012EP3GKD449-W22		
Performed by:		
Checked:		
Customer:		
Three-Phase: W22 Crusher Duty TEFC (IP55)		
Three-phase induction motor Frame 447/9T - IP55	28-SEP-2016	