



Dealers Industrial Equipment

No.:

Date: 28-SEP-2016

Customer :

TECHNICAL PROPOSAL

Three-phase induction motor - Squirrel cage rotor

Product line : W22 High Efficiency
Catalog Number : 25012EP3G449T-W22
List Price : \$>(discontinued)

Notes:
Downloaded from <http://dealerselectric.com>
Generated for Model #25012EP3G449T-W22

Performed by:

Checked:



Dealers Industrial Equipment

No.:

Date: 28-SEP-2016

DATA SHEET Three-phase induction motor - Squirrel cage rotor

Customer :
Product line : W22 High Efficiency

Frame : 447/9T
Output : 250 HP
Frequency : 60 Hz
Poles : 6
Full load speed : 1185 rpm
Slip : 1.25 %
Voltage : 460 V
Rated current : 291 A
Locked rotor current : 1800 A
Locked rotor current (I_L/I_n) : 6.2
No-load current : 105 A
Full load torque : 1093 lb.ft
Locked rotor torque : 220 %
Breakdown torque : 220 %
Design : B
Insulation class : F
Temperature rise : 80 K
Locked rotor time : 11 s (hot)
Service factor : 1.15
Duty cycle : S1
Ambient temperature : -20°C - +40°C
Altitude : 1000 m
Degree of Protection : IP55
Approximate weight : 2452 lb
Moment of inertia : 152.70 sq.ft.lb
Noise level : 70 dB(A)

	D.E.	N.D.E.
Bearings	6322 C3	6319 C3
Regreasing interval	11000 h	13000 h
Grease amount	60 g	45 g

Load	Power factor	Efficiency (%)
100%	0.84	95.0
75%	0.80	95.4
50%	0.71	95.0

Notes:
Downloaded from <http://dealerselectric.com>
Generated for Model #25012EP3G449T-W22

Performed by

Checked



Dealers Industrial Equipment

No.:

Date: 28-SEP-2016

PERFORMANCE CURVES RELATED TO RATED OUTPUT

Three-phase induction motor - Squirrel cage rotor

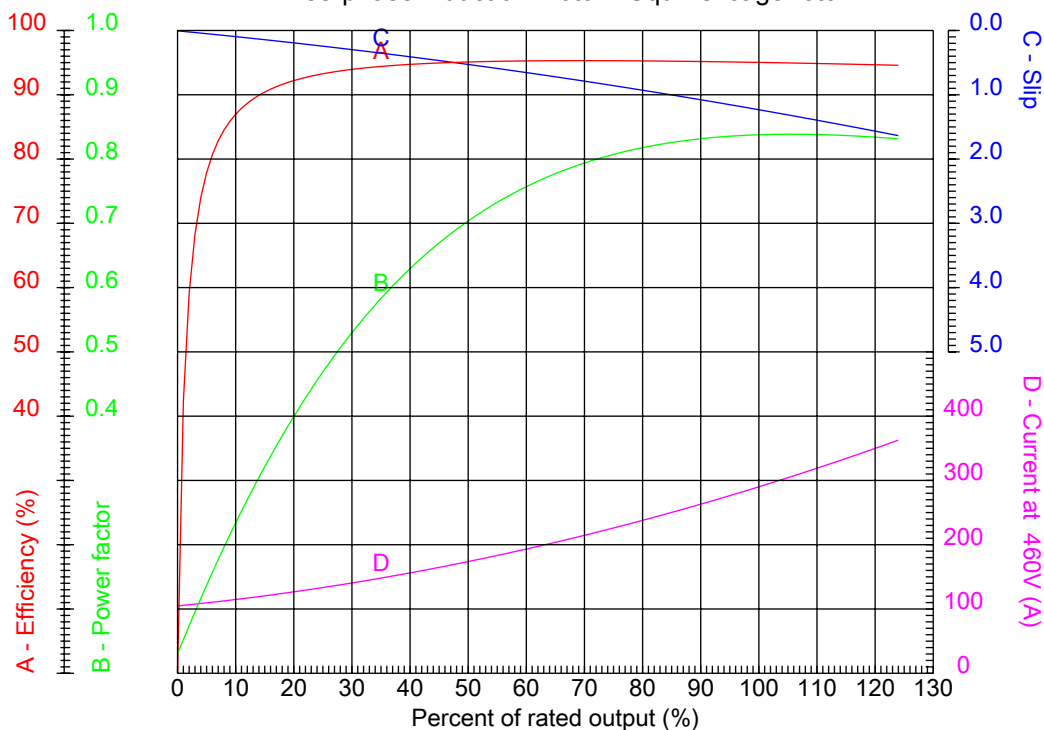

Customer :
Product line : W22 High Efficiency

Frame : 447/9T	Locked rotor current (I _l /I _n) : 6.2
Output : 250 HP	Duty cycle : S1
Frequency : 60 Hz	Service factor : 1.15
Full load speed : 1185 rpm	Design : B
Voltage : 460 V	Locked rotor torque : 220 %
Rated current : 291 A	Breakdown torque : 220 %
Insulation class : F	

Notes:
Downloaded from <http://dealerselectric.com>
Generated for Model #25012EP3G449T-W22

Performed by

Checked



Dealers Industrial Equipment

No.:

Date: 28-SEP-2016

CHARACTERISTIC CURVES RELATED TO SPEED

Three-phase induction motor - Squirrel cage rotor

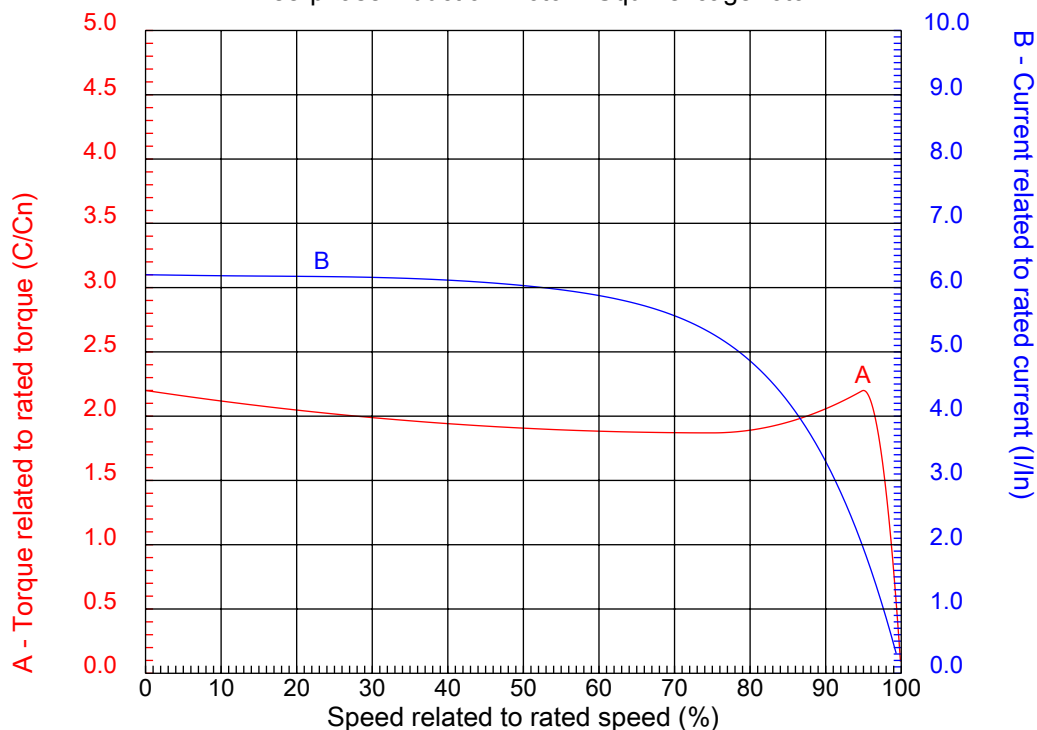

Customer :
Product line : W22 High Efficiency

Frame	: 447/9T	Locked rotor current (I _l /I _n)	: 6.2
Output	: 250 HP	Duty cycle	: S1
Frequency	: 60 Hz	Service factor	: 1.15
Full load speed	: 1185 rpm	Design	: B
Voltage	: 460 V	Locked rotor torque	: 220 %
Rated current	: 291 A	Breakdown torque	: 220 %
Insulation class	: F		

Notes:
Downloaded from <http://dealerselectric.com>
Generated for Model #25012EP3G449T-W22

Performed by

Checked

1 2 3 4 5 6 7 8

A

B

C

D

E

F

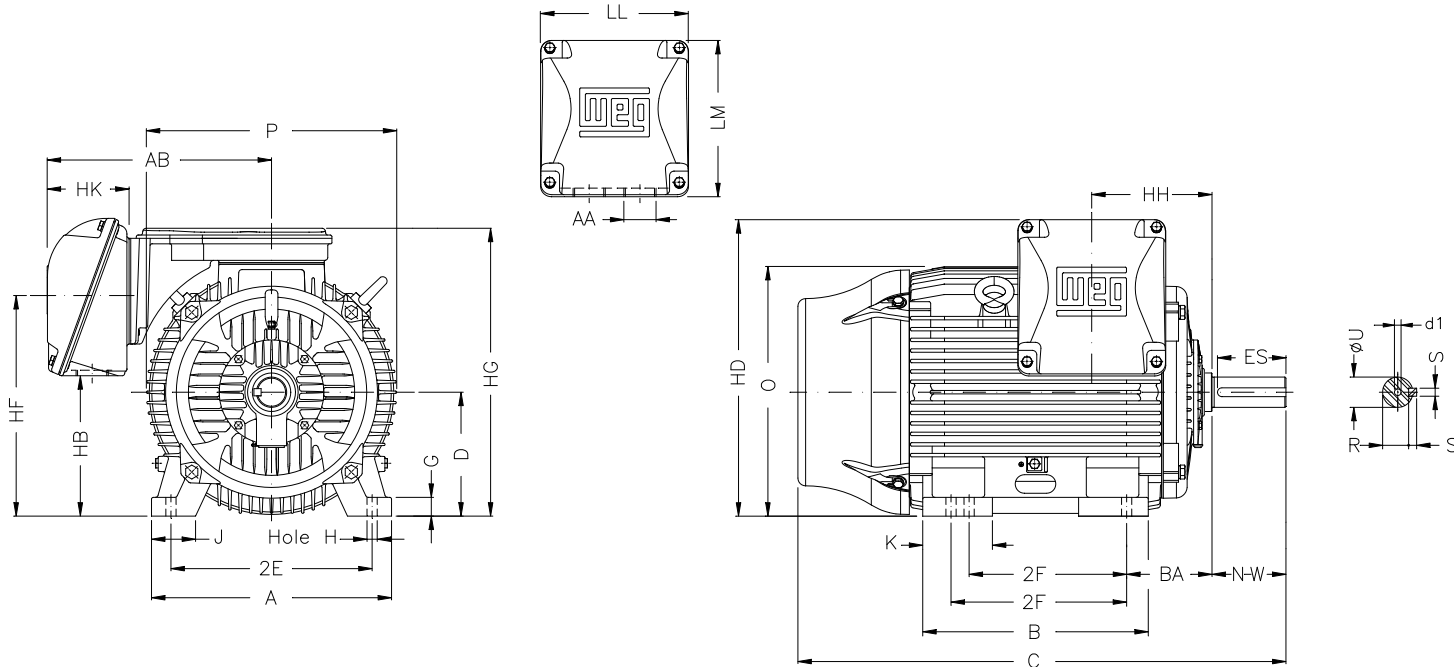

Notes: Downloaded from <http://dealerselectric.com>
Generated for Model #25012EP3G449T-W22

Performed by:

Checked:

Customer:

W22 High Efficiency

Three-phase induction motor
Frame 447/9T - IP55

28-SEP-2016



2E 18.000	J 3.937	A 21.929	P 23.583	AB 20.559
2F 20.000/25.000	K 11.772	B 31.535	BA 7.500	U 3.375
N-W 8.500	ES 7.087	S 0.875	R 2.880	depth 0.875
D 11.000	G 1.630	HB 12.488	O 22.795	HD 27.527
HF 20.724	HG 26.830	HH 11.811	HK 6.929	H 0.810
C 56.338	LL 14.921	LM 15.039	AA 2xNPT 3"	d1 DUNC 3/4"-10

1 2 3 4 5 6 7 8

A

PART-WINDING

WYE-DELTA

START

RUN

START

RUN

B



C

L1 L2 L3

L1 L2 L3

L1 L2 L3

L1 L2 L3

D

E

F

Notes: Downloaded from <http://dealerselectric.com>
 Generated for Model #25012EP3G449T-W22

Performed by:

Checked:

Customer:

W22 High Efficiency

Three-phase induction motor
 Frame 447/9T - IP55

28-SEP-2016

