



Dealers Industrial Equipment

No.:

Date: 28-SEP-2016

Customer :

TECHNICAL PROPOSAL

Three-phase induction motor - Squirrel cage rotor

Product line : ODP – Open Induction Motors – NEMA Premium Efficiency

Catalog Number : 15012OT3G445T

List Price : \$13,615

Notes:

Downloaded from <http://dealerselectric.com>

Generated for Model #15012OT3G445T

Performed by:

Checked:



Dealers Industrial Equipment

No.:

Date: 28-SEP-2016

DATA SHEET Three-phase induction motor - Squirrel cage rotor

Customer :
 Product line : ODP – Open Induction Motors – NEMA Premium Efficiency

Frame : 444/5T
 Output : 150 HP
 Frequency : 60 Hz
 Poles : 6
 Full load speed : 1185 rpm
 Slip : 1.25 %
 Voltage : 460 V
 Rated current : 183 A
 Locked rotor current : 1210 A
 Locked rotor current (I_L/I_n) : 6.6
 No-load current : 85.0 A
 Full load torque : 656 lb.ft
 Locked rotor torque : 220 %
 Breakdown torque : 240 %
 Design : B
 Insulation class : F
 Temperature rise : 80 K
 Locked rotor time : 18 s (hot)
 Service factor : 1.15
 Duty cycle : S1
 Ambient temperature : -20°C - +40°C
 Altitude : 1000 m
 Degree of Protection : IP23
 Approximate weight : 2007 lb
 Moment of inertia : 57.166 sq.ft.lb
 Noise level : 79 dB(A)

	D.E.	N.D.E.
Bearings	6319 C3	6316 C3
Regreasing interval	20000 h	20000 h
Grease amount	45 g	34 g

Load	Power factor	Efficiency (%)
100%	0.79	95.4
75%	0.73	95.0
50%	0.62	94.5

Notes:
 Downloaded from <http://dealerselectric.com>
 Generated for Model #15012OT3G445T

Performed by

Checked



Dealers Industrial Equipment

No.:

Date: 28-SEP-2016

PERFORMANCE CURVES RELATED TO RATED OUTPUT

Three-phase induction motor - Squirrel cage rotor

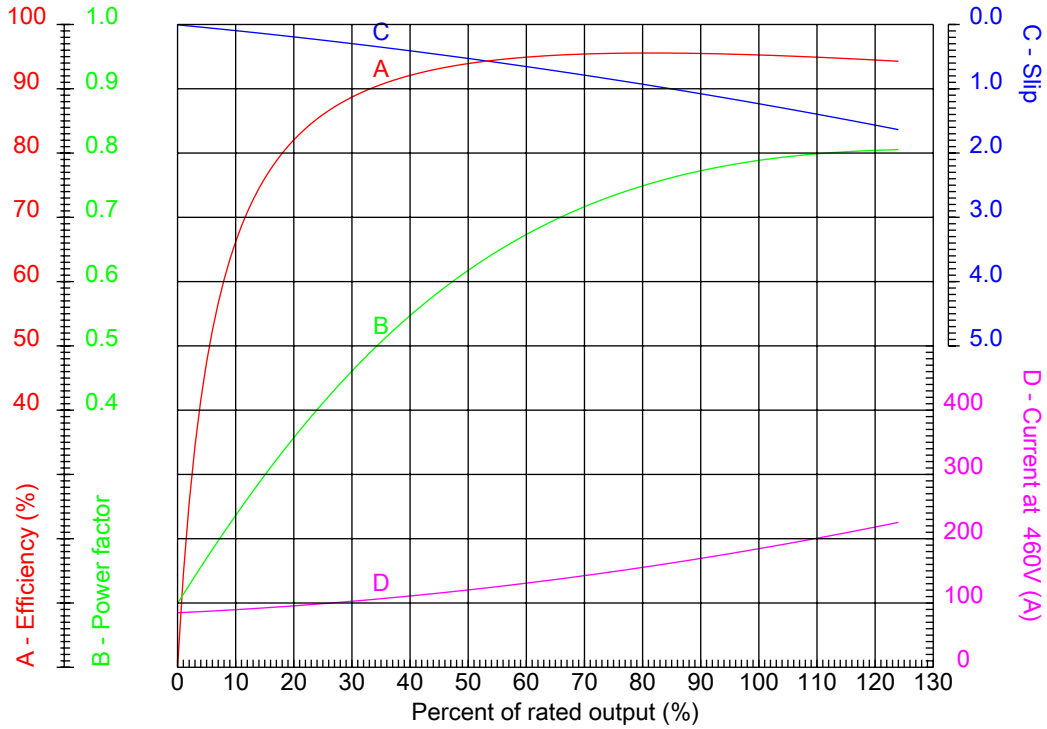

Customer :
 Product line : ODP – Open Induction Motors – NEMA Premium Efficiency

Frame	: 444/5T	Locked rotor current (I _l /I _n)	: 6.6
Output	: 150 HP	Duty cycle	: S1
Frequency	: 60 Hz	Service factor	: 1.15
Full load speed	: 1185 rpm	Design	: B
Voltage	: 460 V	Locked rotor torque	: 220 %
Rated current	: 183 A	Breakdown torque	: 240 %
Insulation class	: F		

Notes:
 Downloaded from <http://dealerselectric.com>
 Generated for Model #15012OT3G445T

Performed by

Checked



Dealers Industrial Equipment

No.:

Date: 28-SEP-2016

CHARACTERISTIC CURVES RELATED TO SPEED

Three-phase induction motor - Squirrel cage rotor

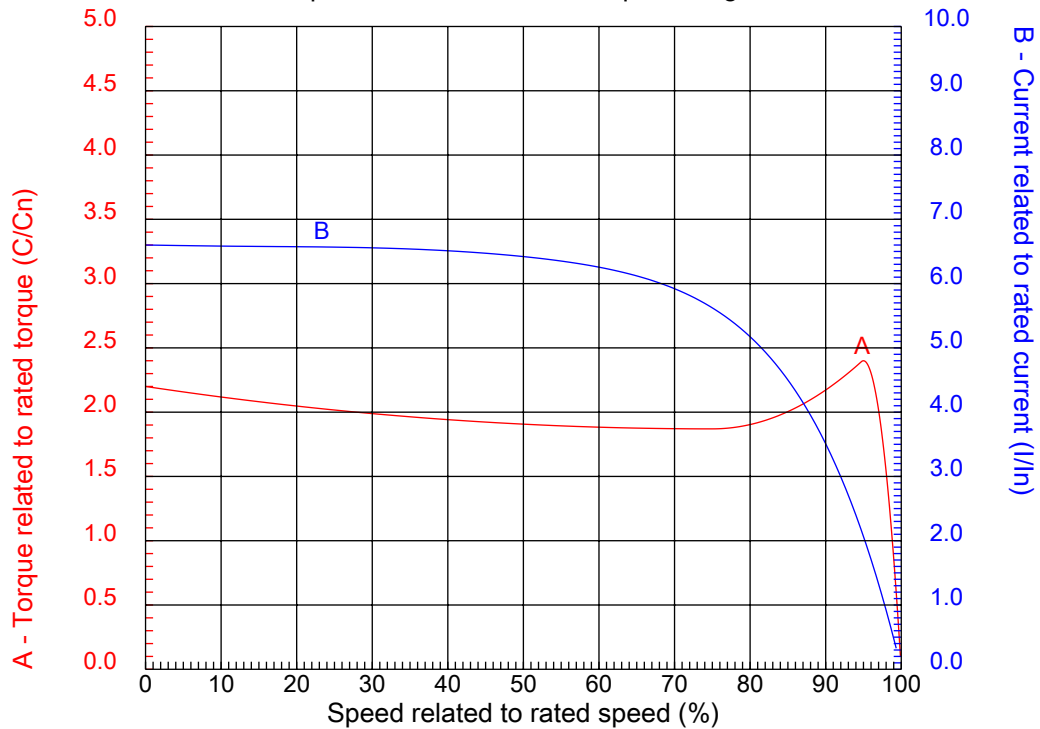

Customer :
Product line : ODP – Open Induction Motors – NEMA Premium Efficiency

Frame	: 444/5T	Locked rotor current (I _l /I _n)	: 6.6
Output	: 150 HP	Duty cycle	: S1
Frequency	: 60 Hz	Service factor	: 1.15
Full load speed	: 1185 rpm	Design	: B
Voltage	: 460 V	Locked rotor torque	: 220 %
Rated current	: 183 A	Breakdown torque	: 240 %
Insulation class	: F		

Notes:
Downloaded from <http://dealerselectric.com>
Generated for Model #15012OT3G445T

Performed by

Checked

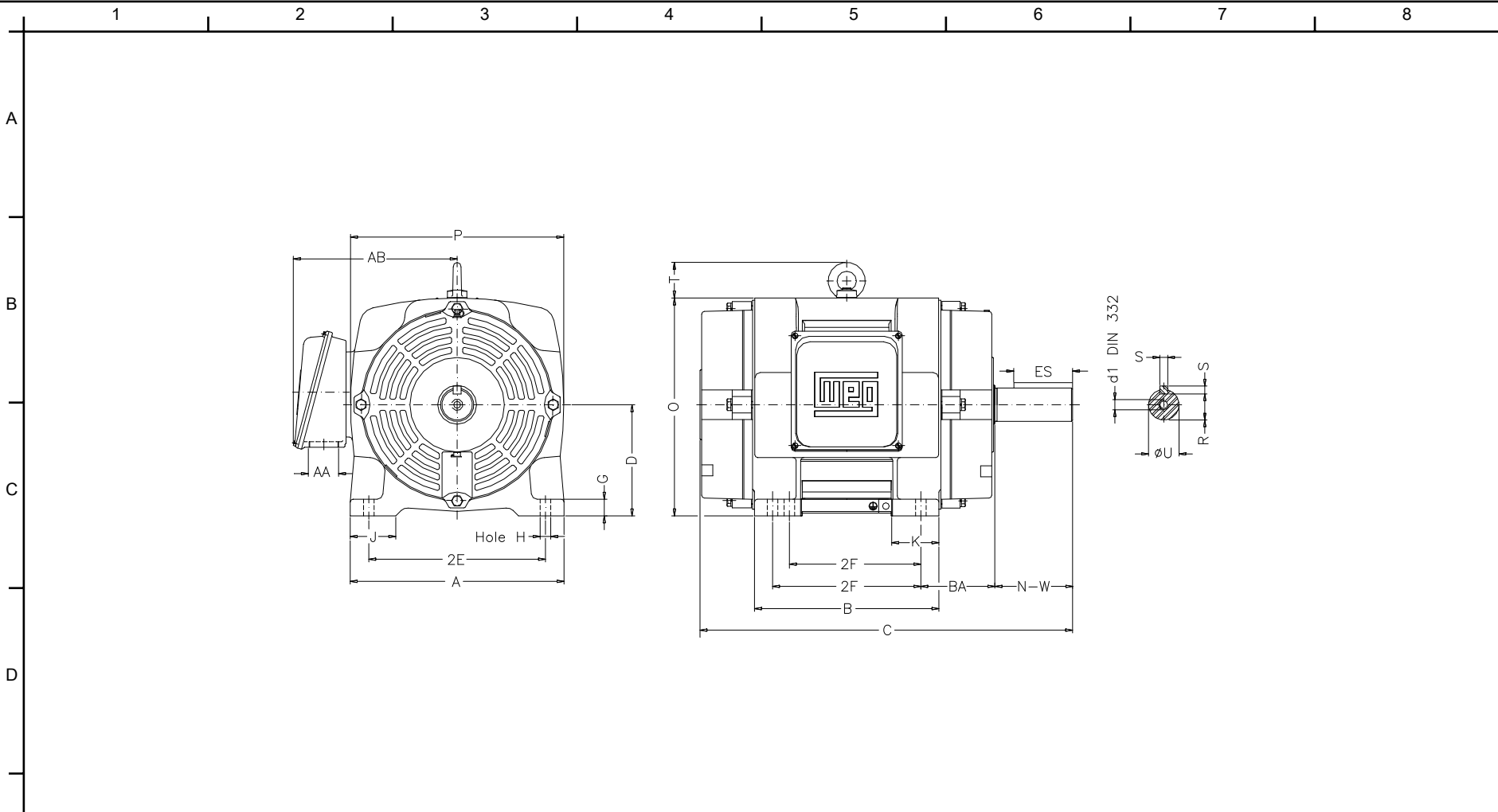

Notes: Downloaded from <http://dealerselectric.com>
 Generated for Model #150120T3G445T

Performed by:

Checked:

Customer:

ODP – Open Induction Motors – NEMA Premium Efficiency

2E 18.000	J 3.937	A 21.929	P 22.125	AB 20.236
2F 14.500/16.500	K 5.590	B 20.078	BA 7.500	U 3.375
d1 DUNC 3/4"-10	N-W 8.500	ES 7.087	S 0.875	R 2.880
depth 0.875	D 11.000	G 1.811	O 22.440	T 3.544
H 0.807	C 39.803	AA 2xNPT 3"		

Three-phase induction motor
 Frame 444/5T - IP23

28-SEP-2016



1 2 3 4 5 6 7 8

A

PART-WINDING

WYE-DELTA

START

RUN

START

RUN

B

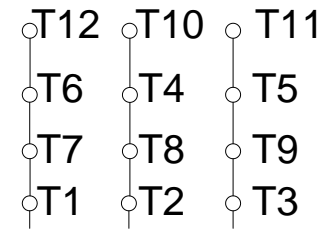
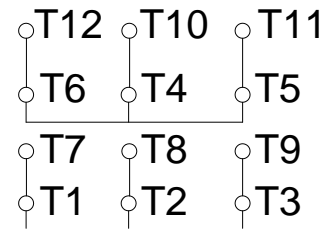
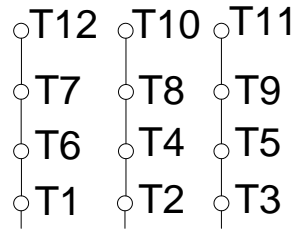
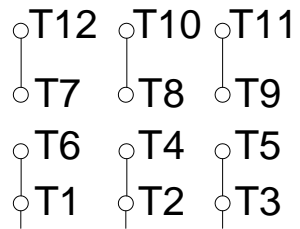

C

L1 L2 L3

L1 L2 L3

L1 L2 L3

L1 L2 L3

D

E

F

Notes: Downloaded from <http://dealerselectric.com>
Generated for Model #15012OT3G445T

Performed by:

Checked:

Customer:

ODP – Open Induction Motors – NEMA Premium Efficiency

Three-phase induction motor
Frame 444/5T - IP23

28-SEP-2016

