



Dealers Industrial Equipment

No.:

Date: 28-SEP-2016

Customer :

TECHNICAL PROPOSAL

Three-phase induction motor - Squirrel cage rotor

Product line : Three-Phase: W22 Crusher Duty TEFC (IP55)

Catalog Number : 12509EP3GKD447T-W22

List Price : \$22,808

Notes:

Downloaded from <http://dealerselectric.com>

Generated for Model #12509EP3GKD447T-W22

Performed by:

Checked:



Dealers Industrial Equipment

No.:

Date: 28-SEP-2016

DATA SHEET Three-phase induction motor - Squirrel cage rotor

Customer :
 Product line : Three-Phase: W22 Crusher Duty TEFC (IP55)

Frame : 445/7T
 Output : 125 HP
 Frequency : 60 Hz
 Poles : 8
 Full load speed : 885 rpm
 Slip : 1.67 %
 Voltage : 460 V
 Rated current : 151 A
 Locked rotor current : 876 A
 Locked rotor current (I_L/I_n) : 5.8
 No-load current : 60.0 A
 Full load torque : 732 lb.ft
 Locked rotor torque : 180 %
 Breakdown torque : 200 %
 Design : A
 Insulation class : F
 Temperature rise : 80 K
 Locked rotor time : 15 s (hot)
 Service factor : 1.15
 Duty cycle : S1
 Ambient temperature : -20°C - +40°C
 Altitude : 1000 m
 Degree of Protection : IP55
 Approximate weight : 1806 lb
 Moment of inertia : 103.62 sq.ft.lb
 Noise level : 63 dB(A)

	D.E.	N.D.E.
Bearings	NU-319 C3	6316 C3
Regreasing interval	15000 h	20000 h
Grease amount	45 g	34 g

Load	Power factor	Efficiency (%)
100%	0.80	93.6
75%	0.76	94.1
50%	0.67	93.6

Notes:
 Downloaded from <http://dealerselectric.com>
 Generated for Model #12509EP3GKD447T-W22

Performed by

Checked



Dealers Industrial Equipment

No.:

Date: 28-SEP-2016

PERFORMANCE CURVES RELATED TO RATED OUTPUT

Three-phase induction motor - Squirrel cage rotor

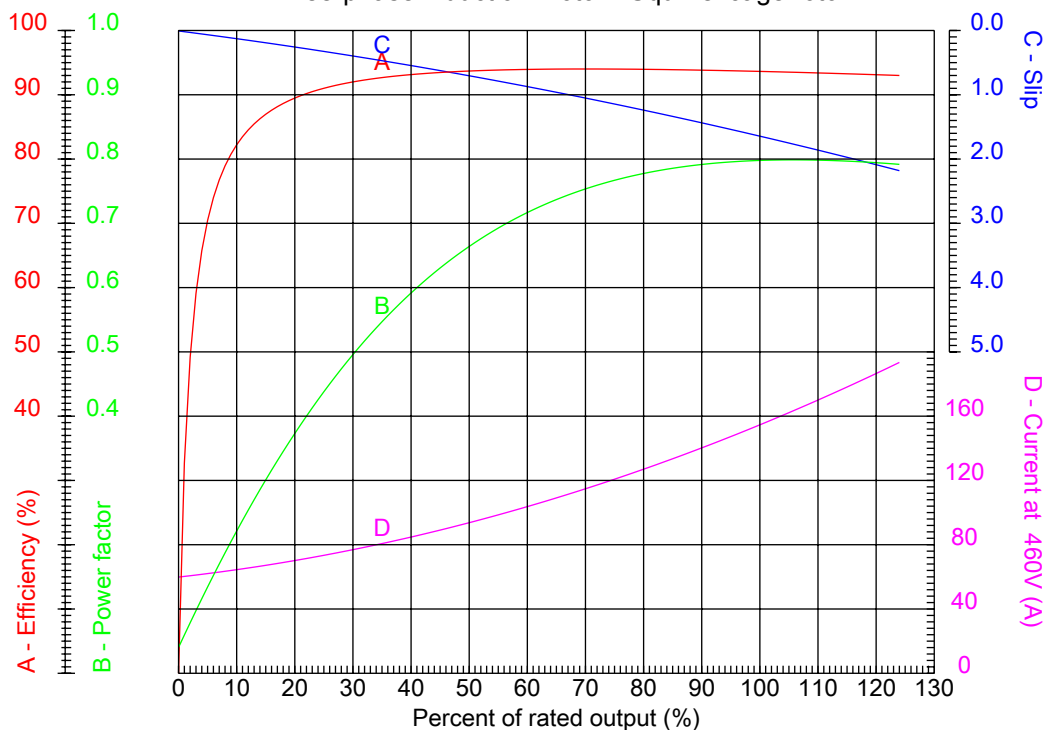

Customer :
 Product line : Three-Phase: W22 Crusher Duty TEFC (IP55)

Frame	: 445/7T	Locked rotor current (I _l /I _n)	: 5.8
Output	: 125 HP	Duty cycle	: S1
Frequency	: 60 Hz	Service factor	: 1.15
Full load speed	: 885 rpm	Design	: A
Voltage	: 460 V	Locked rotor torque	: 180 %
Rated current	: 151 A	Breakdown torque	: 200 %
Insulation class	: F		

Notes:
 Downloaded from <http://dealerselectric.com>
 Generated for Model #12509EP3GKD447T-W22

Performed by

Checked



Dealers Industrial Equipment

No.:

Date: 28-SEP-2016

CHARACTERISTIC CURVES RELATED TO SPEED

Three-phase induction motor - Squirrel cage rotor

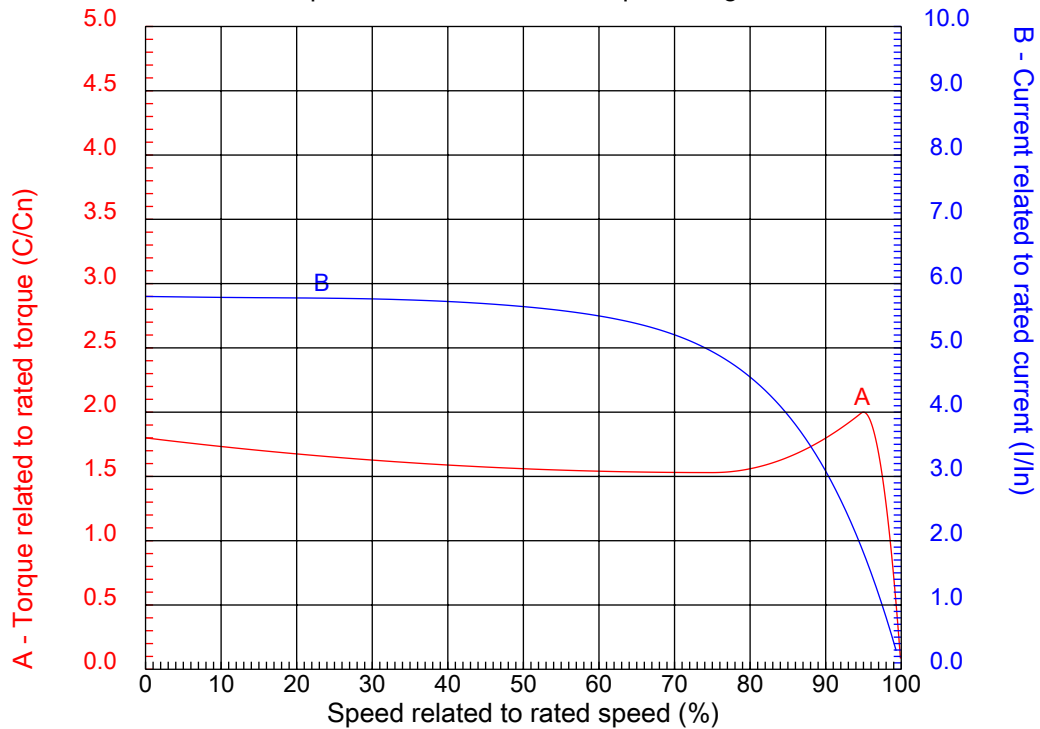

Customer :
Product line : Three-Phase: W22 Crusher Duty TEFC (IP55)

Frame	: 445/7T	Locked rotor current (I _l /I _n)	: 5.8
Output	: 125 HP	Duty cycle	: S1
Frequency	: 60 Hz	Service factor	: 1.15
Full load speed	: 885 rpm	Design	: A
Voltage	: 460 V	Locked rotor torque	: 180 %
Rated current	: 151 A	Breakdown torque	: 200 %
Insulation class	: F		

Notes:
Downloaded from <http://dealerselectric.com>
Generated for Model #12509EP3GKD447T-W22

Performed by

Checked

1 2 3 4 5 6 7 8

A

B

C

D

E

F

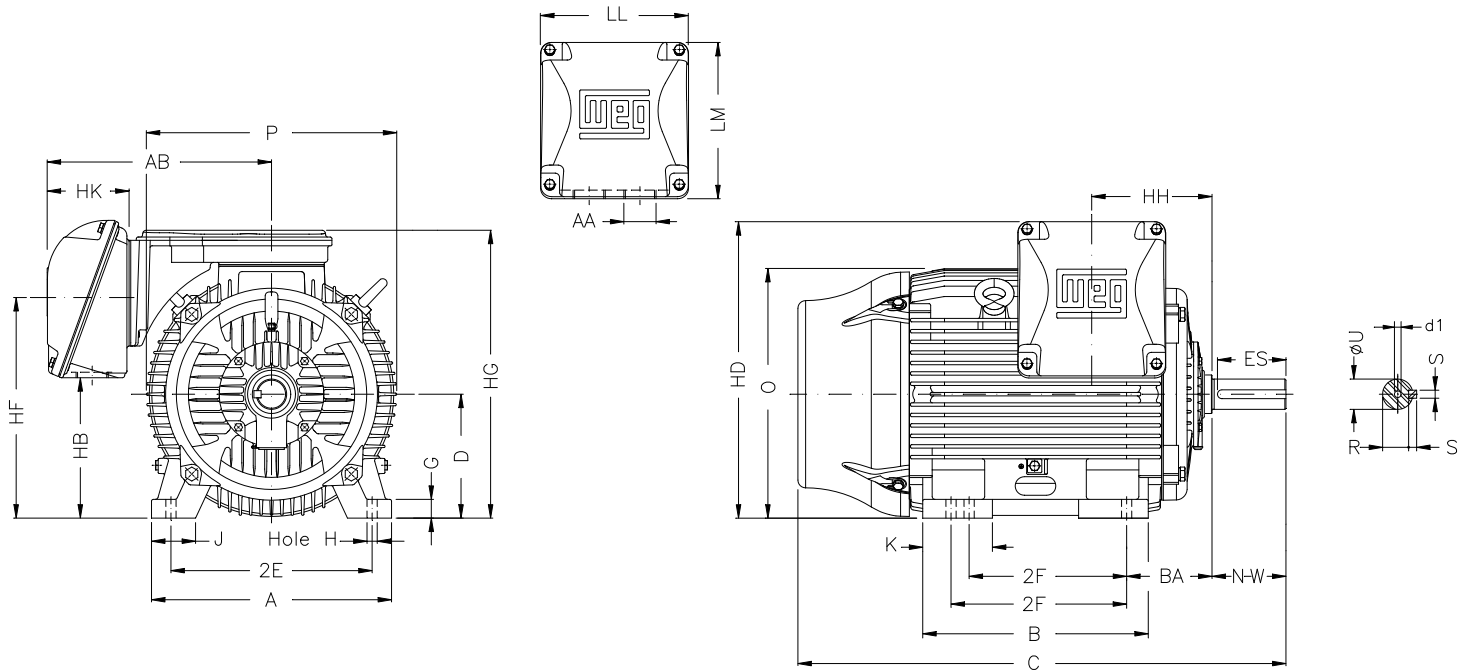

Notes: Downloaded from <http://dealerselectric.com>
Generated for Model #12509EP3GKD447T-W22

Performed by:

Checked:

Customer:

Three-Phase: W22 Crusher Duty TEFC (IP55)

Three-phase induction motor
Frame 445/7T - IP55

28-SEP-2016



AB 20.670	2F 16.500/20.000	B 23.897	U 3.375	N-W 8.500
ES 7.087	S 0.875	R 2.880	depth 0.875	HB 12.598
HF 20.724	HG 26.850	HH 11.811	HK 6.968	C 48.701
LL 14.646	LM 15.040	AA 2xNPT 3"	d1 DUNC 3/4"-10	d2 DUNC 3/4"-10

1 2 3 4 5 6 7 8

A

PART-WINDING

WYE-DELTA

START

RUN

START

RUN

B



C

L1 L2 L3

L1 L2 L3

L1 L2 L3

L1 L2 L3

D

E

F

Notes: Downloaded from <http://dealerselectric.com>
Generated for Model #12509EP3GKD447T-W22

Performed by:

Checked:

Customer:

Three-Phase: W22 Crusher Duty TEFC (IP55)

Three-phase induction motor
Frame 445/7T - IP55

28-SEP-2016

