



Dealers Industrial Equipment

No.:

Date: 28-SEP-2016

Customer :

TECHNICAL PROPOSAL

Three-phase induction motor - Squirrel cage rotor

Product line : ODP – Open Induction Motors – NEMA Premium Efficiency

Catalog Number : 10036OT3G365TS

List Price : \$6,644

Notes:

Downloaded from <http://dealerselectric.com>

Generated for Model #10036OT3G365TS

Performed by:

Checked:



# Dealers Industrial Equipment

No.:

Date: 28-SEP-2016

## DATA SHEET Three-phase induction motor - Squirrel cage rotor

Customer :  
 Product line : ODP – Open Induction Motors – NEMA Premium Efficiency

Frame : 365TS  
 Output : 100 HP  
 Frequency : 60 Hz  
 Poles : 2  
 Full load speed : 3550 rpm  
 Slip : 1.39 %  
 Voltage : 460 V  
 Rated current : 111 A  
 Locked rotor current : 744 A  
 Locked rotor current (I<sub>L</sub>/I<sub>n</sub>) : 6.7  
 No-load current : 34.0 A  
 Full load torque : 146 lb.ft  
 Locked rotor torque : 190 %  
 Breakdown torque : 280 %  
 Design : B  
 Insulation class : F  
 Temperature rise : 80 K  
 Locked rotor time : 12 s (hot)  
 Service factor : 1.15  
 Duty cycle : S1  
 Ambient temperature : -20°C - +40°C  
 Altitude : 1000 m  
 Degree of Protection : IP23  
 Approximate weight : 587 lb  
 Moment of inertia : 8.3008 sq.ft.lb  
 Noise level : 83 dB(A)

	D.E.	N.D.E.
Bearings	6314 C3	6314 C3
Regreasing interval	14418 h	14418 h
Grease amount	27 g	27 g

Load	Power factor	Efficiency (%)
100%	0.90	94.5
75%	0.89	94.5
50%	0.84	94.1

Notes:  
 Downloaded from <http://dealerselectric.com>  
 Generated for Model #10036OT3G365TS

Performed by

Checked



# Dealers Industrial Equipment

No.:

Date: 28-SEP-2016

## PERFORMANCE CURVES RELATED TO RATED OUTPUT

Three-phase induction motor - Squirrel cage rotor

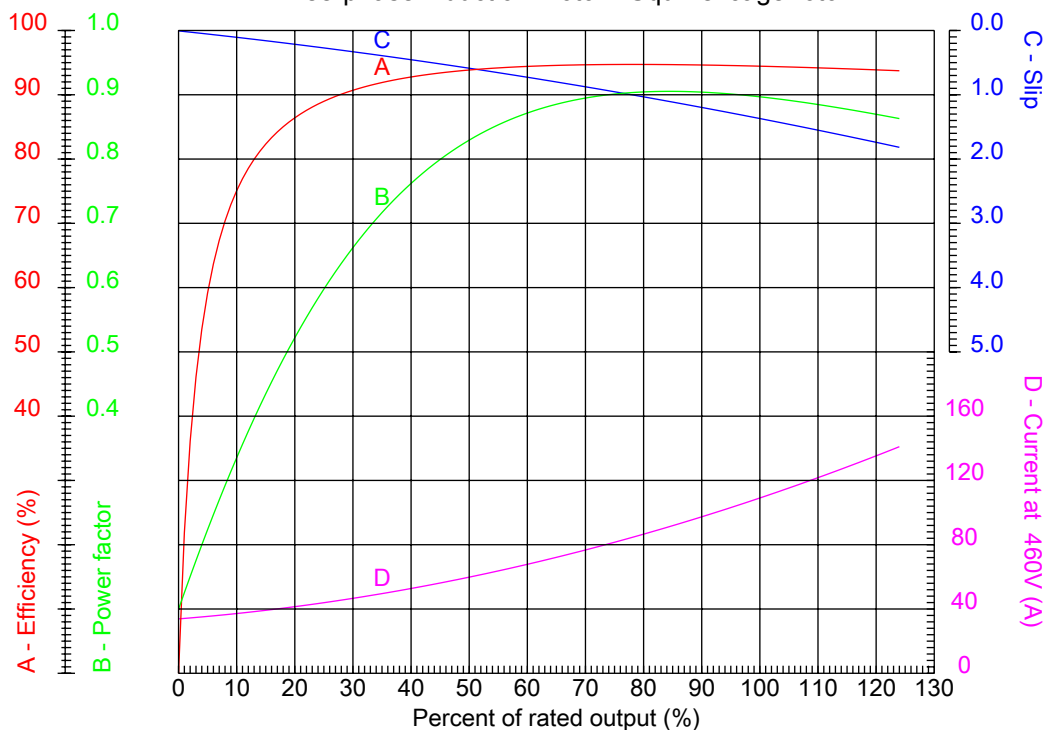

Customer :  
Product line : ODP – Open Induction Motors – NEMA Premium Efficiency

Frame	: 365TS	Locked rotor current (I <sub>l</sub> /I <sub>n</sub> )	: 6.7
Output	: 100 HP	Duty cycle	: S1
Frequency	: 60 Hz	Service factor	: 1.15
Full load speed	: 3550 rpm	Design	: B
Voltage	: 460 V	Locked rotor torque	: 190 %
Rated current	: 111 A	Breakdown torque	: 280 %
Insulation class	: F		

Notes:  
Downloaded from <http://dealerselectric.com>  
Generated for Model #10036OT3G365TS

Performed by

Checked



# Dealers Industrial Equipment

No.:

Date: 28-SEP-2016

## CHARACTERISTIC CURVES RELATED TO SPEED

Three-phase induction motor - Squirrel cage rotor

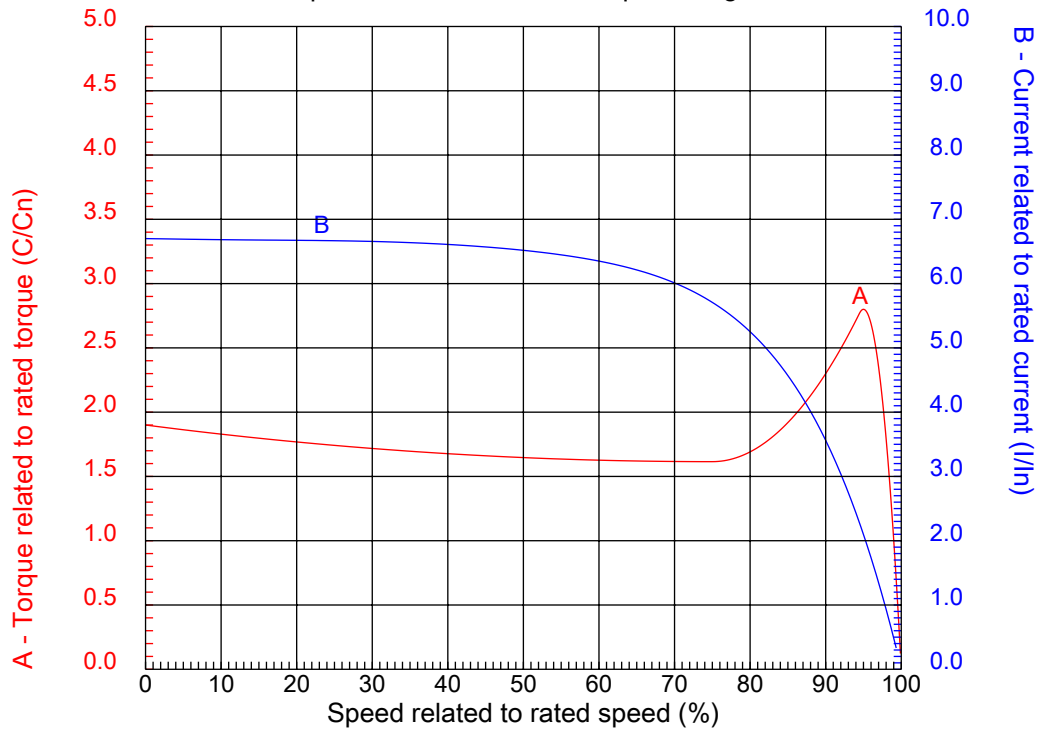

Customer :  
Product line : ODP – Open Induction Motors – NEMA Premium Efficiency

Frame	: 365TS	Locked rotor current (I <sub>l</sub> /I <sub>n</sub> )	: 6.7
Output	: 100 HP	Duty cycle	: S1
Frequency	: 60 Hz	Service factor	: 1.15
Full load speed	: 3550 rpm	Design	: B
Voltage	: 460 V	Locked rotor torque	: 190 %
Rated current	: 111 A	Breakdown torque	: 280 %
Insulation class	: F		

Notes:  
Downloaded from <http://dealerselectric.com>  
Generated for Model #10036OT3G365TS

Performed by

Checked

1 2 3 4 5 6 7 8

A  
B  
C  
D  
E  
F

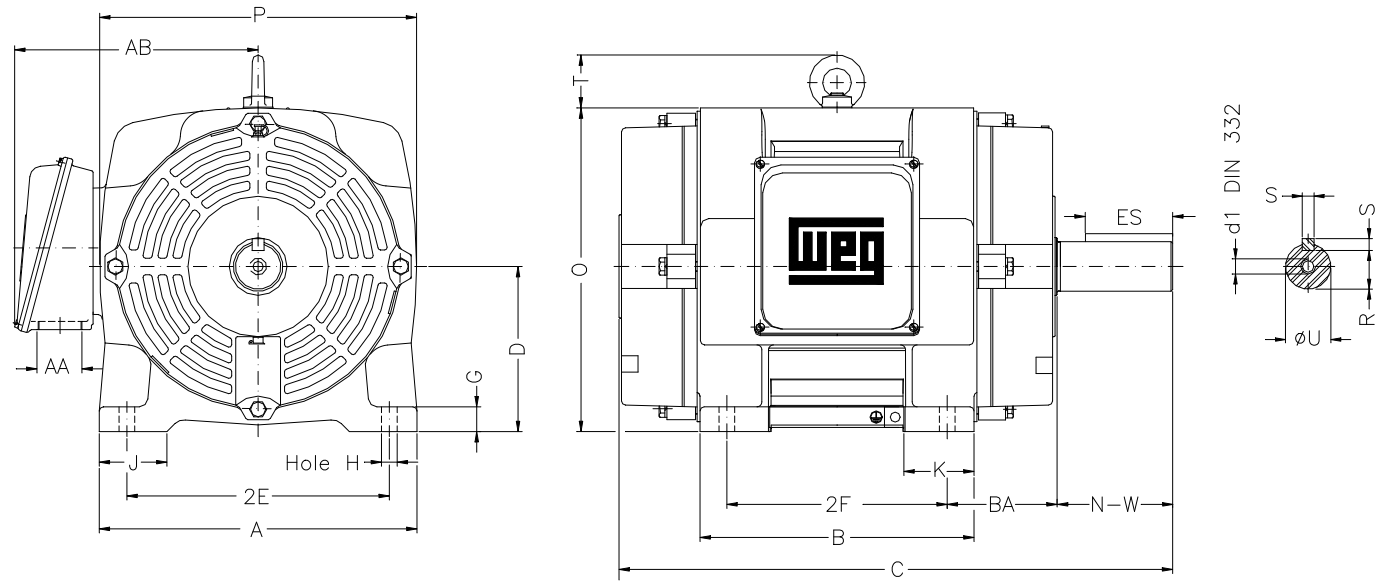

Notes: Downloaded from <http://dealerselectric.com>  
Generated for Model #100360T3G365TS

Performed by:

Checked:

Customer:

ODP – Open Induction Motors – NEMA Premium Efficiency

2E 14.000	J 3.150	A 17.170	P 17.874	AB 16.378
2F 11.250/12.250	K 4.140	B 15.400	BA 5.875	U 1.875
d1 DUNC 3/4"-10	N-W 3.748	ES 1.968	S 0.500	R 1.591
depth 0.500	D 9.000	G 1.480	O 18.425	T 2.795
H 0.657	C 27.638	AA NPT 3"		

Three-phase induction motor  
Frame 365TS - IP23

28-SEP-2016



1 2 3 4 5 6 7 8

A

### PART-WINDING

### WYE-DELTA

#### START

#### RUN

#### START

#### RUN

B

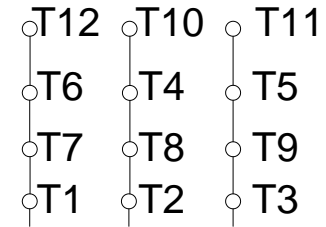
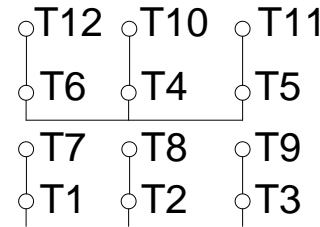
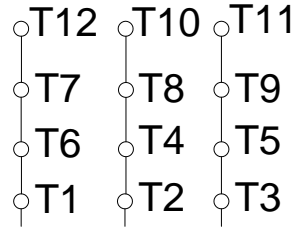
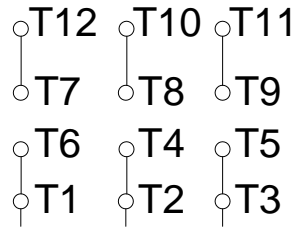

C

L1 L2 L3

L1 L2 L3

L1 L2 L3

L1 L2 L3

D

E

F

Notes: Downloaded from <http://dealerselectric.com>  
 Generated for Model #100360T3G365TS

Performed by:

Checked:

Customer:

ODP – Open Induction Motors – NEMA Premium Efficiency

Three-phase induction motor  
 Frame 365TS - IP23

28-SEP-2016

