



Dealers Industrial Equipment

No.:

Date: 27-SEP-2016

Customer :

TECHNICAL PROPOSAL

Three-phase induction motor - Squirrel cage rotor

Product line : Three-Phase: W22 IEEE-841™ Petrochem Motors - NEMA Premium® Efficiency

Catalog Number : 07512ST3HIE405T-W22

List Price : \$12,866

Notes:

Downloaded from <http://dealerselectric.com>

Generated for Model #07512ST3HIE405T-W22

Performed by:

Checked:



Dealers Industrial Equipment

No.:

Date: 27-SEP-2016

DATA SHEET Three-phase induction motor - Squirrel cage rotor

Customer :
 Product line : Three-Phase: W22 IEEE-841™ Petrochem Motors - NEMA Premium® Efficiency

Frame : 404/5T
 Output : 75 HP
 Frequency : 60 Hz
 Poles : 6
 Full load speed : 1180 rpm
 Slip : 1.67 %
 Voltage : 575 V
 Rated current : 67.9 A
 Locked rotor current : 435 A
 Locked rotor current (I_L/I_n) : 6.4
 No-load current : 24.0 A
 Full load torque : 329 lb.ft
 Locked rotor torque : 200 %
 Breakdown torque : 230 %
 Design : B
 Insulation class : F
 Temperature rise : 80 K
 Locked rotor time : 17 s (hot)
 Service factor : 1.25
 Duty cycle : S1
 Ambient temperature : -20°C - +40°C
 Altitude : 1000 m
 Degree of Protection : IP55
 Approximate weight : 1089 lb
 Moment of inertia : 40.209 sq.ft.lb
 Noise level : 68 dB(A)

	D.E.	N.D.E.
Bearings	6316 C3	6314 C3
Regreasing interval	16000 h	17000 h
Grease amount	34 g	27 g

Load	Power factor	Efficiency (%)
100%	0.86	94.5
75%	0.83	94.5
50%	0.74	94.1

Notes:
 Downloaded from <http://dealerselectric.com>
 Generated for Model #07512ST3HIE405T-W22

Performed by

Checked



Dealers Industrial Equipment

No.:

Date: 27-SEP-2016

PERFORMANCE CURVES RELATED TO RATED OUTPUT

Three-phase induction motor - Squirrel cage rotor

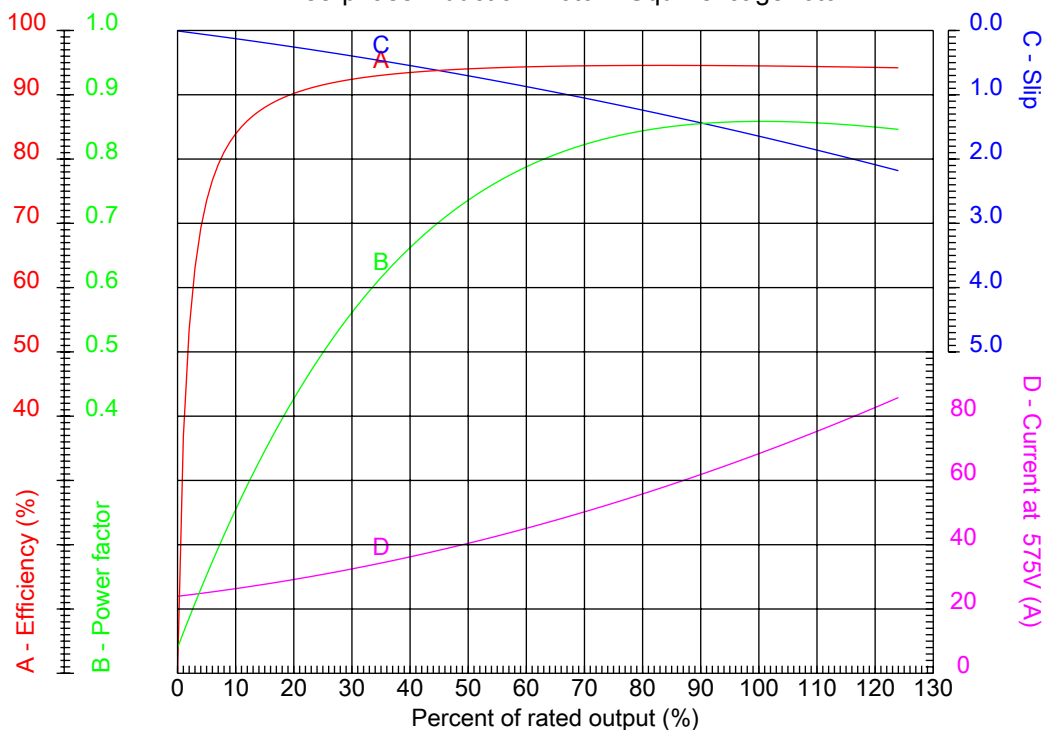

Customer :
 Product line : Three-Phase: W22 IEEE-841™ Petrochem Motors - NEMA Premium® Efficiency

Frame	: 404/5T	Locked rotor current (I _l /I _n)	: 6.4
Output	: 75 HP	Duty cycle	: S1
Frequency	: 60 Hz	Service factor	: 1.25
Full load speed	: 1180 rpm	Design	: B
Voltage	: 575 V	Locked rotor torque	: 200 %
Rated current	: 67.9 A	Breakdown torque	: 230 %
Insulation class	: F		

Notes:
 Downloaded from <http://dealerselectric.com>
 Generated for Model #07512ST3HIE405T-W22

Performed by

Checked



CHARACTERISTIC CURVES RELATED TO SPEED

Three-phase induction motor - Squirrel cage rotor

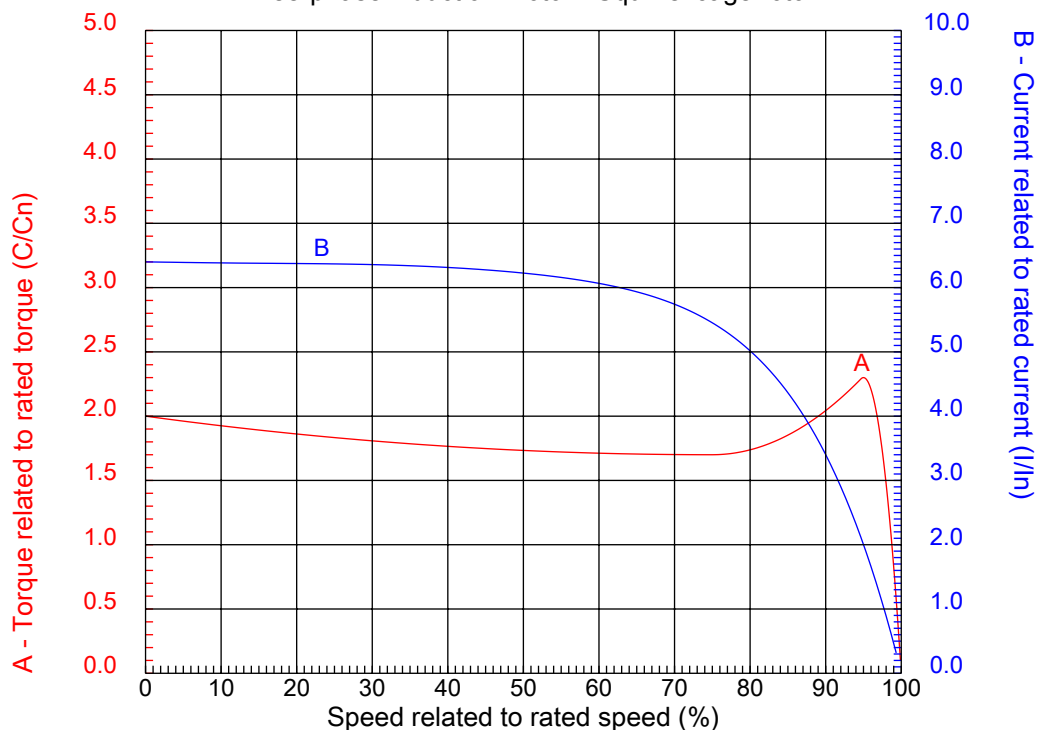

Customer :
Product line : Three-Phase: W22 IEEE-841™ Petrochem Motors - NEMA Premium® Efficiency

Frame	: 404/5T	Locked rotor current (I _l /I _n)	: 6.4
Output	: 75 HP	Duty cycle	: S1
Frequency	: 60 Hz	Service factor	: 1.25
Full load speed	: 1180 rpm	Design	: B
Voltage	: 575 V	Locked rotor torque	: 200 %
Rated current	: 67.9 A	Breakdown torque	: 230 %
Insulation class	: F		

Notes:
Downloaded from <http://dealerselectric.com>
Generated for Model #07512ST3HIE405T-W22

Performed by

Checked

1 2 3 4 5 6 7 8

A

B

C

D

E

F

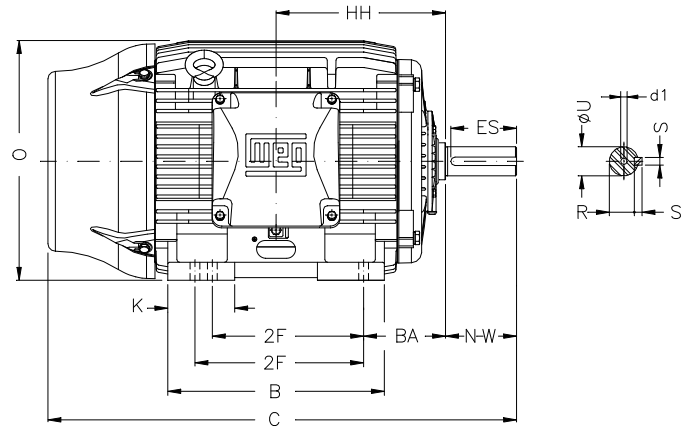

Notes: Downloaded from <http://dealerselectric.com>
Generated for Model #07512ST3HIE405T-W22

Performed by:

Checked:

Customer:

Three-Phase: W22 IEEE-841™ Petrochem Motors - NEMA Premium® Efficiency

Three-phase induction motor
Frame 404/5T - IP55

27-SEP-2016



2E 15.984	J 3.937	A 19.921	P 19.134	AB 16.016
2F 12.244/13.740	K 5.669	B 18.386	BA 6.625	U 2.875
N-W 7.250	ES 5.708	S 0.750	R 2.449	depth 0.750
D 10.000	G 1.811	HB 5.252	O 19.566	HH 13.496
HK 6.024	H 0.810	C 39.730	LL 10.591	LM 11.267
AA NPT 3"	d1 DUNC 3/4"-10	d2 DUNC 3/4"-10		

1 2 3 4 5 6 7 8

A

B

C

D

E

F



Notes: Downloaded from <http://dealerselectric.com>
Generated for Model #07512ST3HIE405T-W22

Performed by:

Checked:

Customer:

Three-Phase: W22 IEEE-841™ Petrochem Motors - NEMA Premium® Efficiency

Three-phase induction motor
Frame 404/5T - IP55

27-SEP-2016

