



Dealers Industrial Equipment

No.:

Date: 27-SEP-2016

Customer :

TECHNICAL PROPOSAL

Three-phase induction motor - Squirrel cage rotor

Product line : Close Coupled Pump: Three-Phase - W22 "JP" Type - TEFC - NEMA Premium

Catalog Number : 06018ET3H364JP-W22

List Price : \$9,619

Notes:

Downloaded from <http://dealerselectric.com>

Generated for Model #06018ET3H364JP-W22

Performed by:

Checked:



Dealers Industrial Equipment

No.:

Date: 27-SEP-2016

DATA SHEET Three-phase induction motor - Squirrel cage rotor

Customer :
 Product line : Close Coupled Pump: Three-Phase - W22 "JP" Type - TEFC - NEMA Premium

Frame : 364/5JP
 Output : 60 HP
 Frequency : 60 Hz
 Poles : 4
 Full load speed : 1775 rpm
 Slip : 1.39 %
 Voltage : 575 V
 Rated current : 54.6 A
 Locked rotor current : 361 A
 Locked rotor current (I_L/I_n) : 6.6
 No-load current : 19.2 A
 Full load torque : 175 lb.ft
 Locked rotor torque : 240 %
 Breakdown torque : 260 %
 Design : B
 Insulation class : F
 Temperature rise : 80 K
 Locked rotor time : 15 s (hot)
 Service factor : 1.25
 Duty cycle : S1
 Ambient temperature : -20°C - +40°C
 Altitude : 1000 m
 Degree of Protection : IP55
 Approximate weight : 869 lb
 Moment of inertia : 22.421 sq.ft.lb
 Noise level : 67 dB(A)

	D.E.	N.D.E.	Load	Power factor	Efficiency (%)
Bearings	6314 C3	6314 C3	100%	0.87	95.0
Regreasing interval	12000 h	12000 h	75%	0.83	94.5
Grease amount	27 g	27 g	50%	0.75	94.1

Notes:
 Downloaded from <http://dealerselectric.com>
 Generated for Model #06018ET3H364JP-W22

Performed by

Checked



Dealers Industrial Equipment

No.:

Date: 27-SEP-2016

PERFORMANCE CURVES RELATED TO RATED OUTPUT

Three-phase induction motor - Squirrel cage rotor

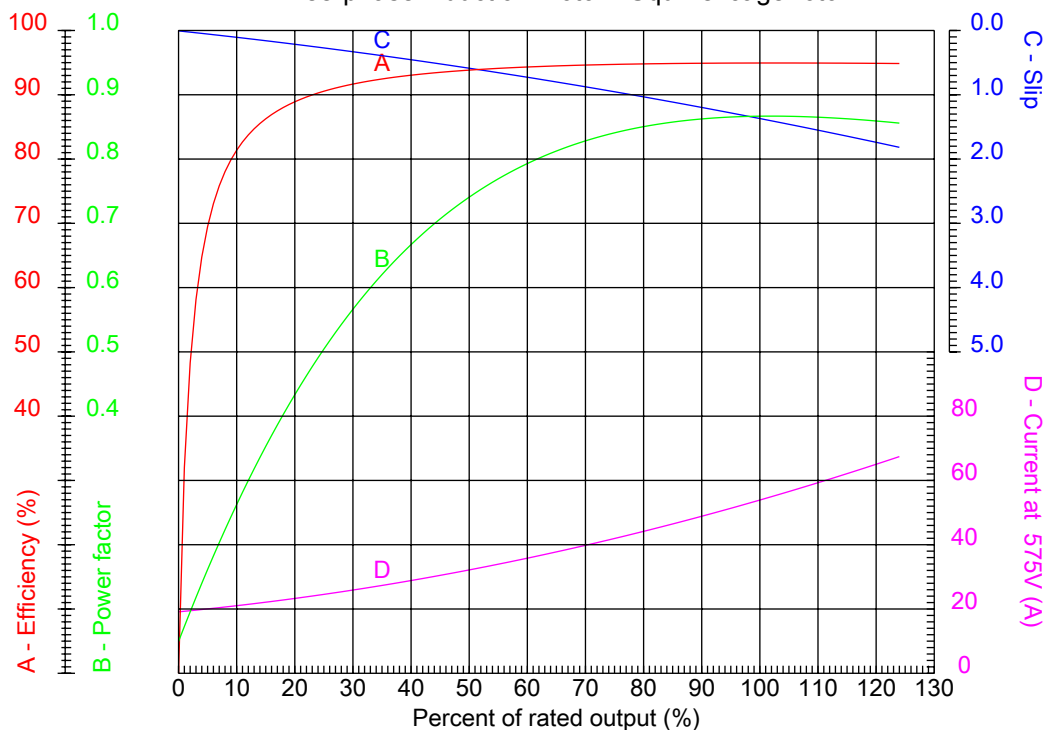

Customer :
 Product line : Close Coupled Pump: Three-Phase - W22 "JP" Type - TEFC - NEMA Premium

Frame	: 364/5JP	Locked rotor current (I _L /I _n)	: 6.6
Output	: 60 HP	Duty cycle	: S1
Frequency	: 60 Hz	Service factor	: 1.25
Full load speed	: 1775 rpm	Design	: B
Voltage	: 575 V	Locked rotor torque	: 240 %
Rated current	: 54.6 A	Breakdown torque	: 260 %
Insulation class	: F		

Notes:
 Downloaded from <http://dealerselectric.com>
 Generated for Model #06018ET3H364JP-W22

Performed by

Checked



Dealers Industrial Equipment

No.:

Date: 27-SEP-2016

CHARACTERISTIC CURVES RELATED TO SPEED

Three-phase induction motor - Squirrel cage rotor

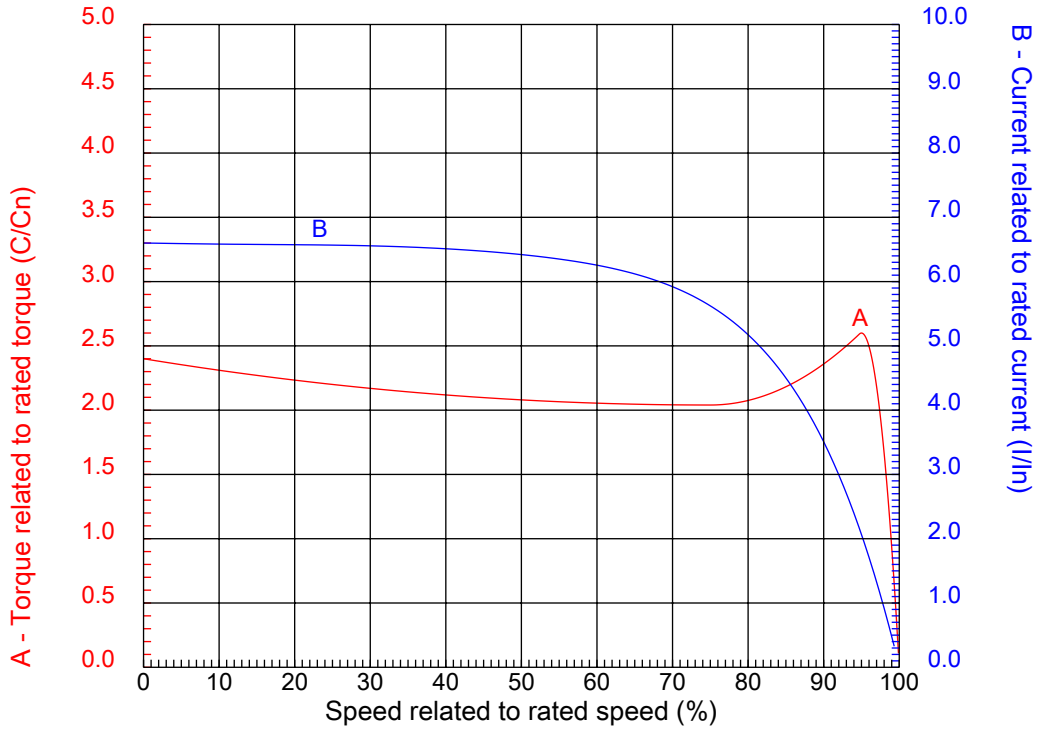

Customer	:	
Product line	:	Close Coupled Pump: Three-Phase - W22 "JP" Type - TEFC - NEMA Premium

Frame	:	364/5JP	Locked rotor current (I _l /I _n)	:	6.6
Output	:	60 HP	Duty cycle	:	S1
Frequency	:	60 Hz	Service factor	:	1.25
Full load speed	:	1775 rpm	Design	:	B
Voltage	:	575 V	Locked rotor torque	:	240 %
Rated current	:	54.6 A	Breakdown torque	:	260 %
Insulation class	:	F			

Notes:
 Downloaded from <http://dealerselectric.com>
 Generated for Model #06018ET3H364JP-W22

Performed by

Checked

1 2 3 4 5 6 7 8

A

B

C

D

E

F

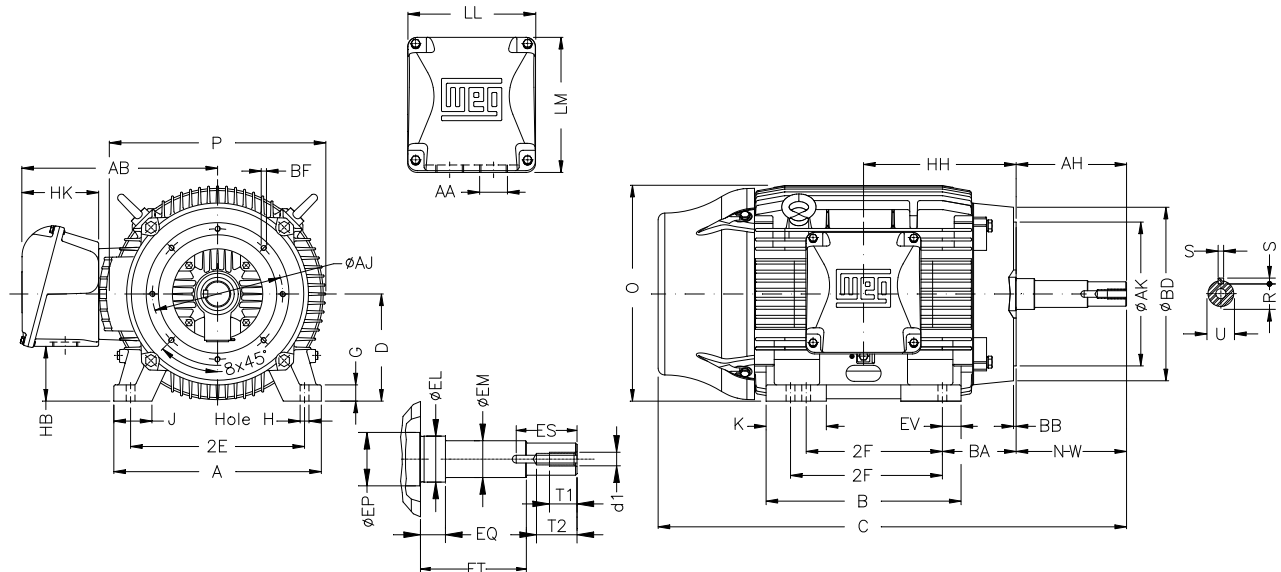

Notes: Downloaded from <http://dealerselectric.com>
Generated for Model #06018ET3H364JP-W22

2E	J	A	P	AB
14.016	3.150	17.165	17.914	16.016
2F	K	B	BA	D
11.260/12.244	4.138	16.220	5.875	9.000
G	O	H	AA	EQ
1.480	17.716	0.660	NPT 3"	2.382
ET	U	EM	EL	EP
5.886	1.624	1.750	2.125	2.756
ES	t1	t2	C	d1
2.480	0.984	1.496	35.916	EUNC 1/2"-13
HH	HK	HB	LL	LM
11.988	6.024	4.251	10.591	11.267
S	R	Flange	AJ	AK
0.375	1.413	FC-279	11.000	12.500
BD	BF	BB	AH	
15.562	UNC 5/8"x11	0.248	8.130	

Performed by:

Checked:

Customer:

Close Coupled Pump: Three-Phase - W22 "JP" Type - TEFC - NEMA Premium

Three-phase induction motor
Frame 364/5JP - IP55

27-SEP-2016



1 2 3 4 5 6 7 8

A

B

C

D

E

F



Notes: Downloaded from <http://dealerselectric.com>
Generated for Model #06018ET3H364JP-W22

Performed by:

Checked:

Customer:

Close Coupled Pump: Three-Phase - W22 "JP" Type - TEFC - NEMA Premium

Three-phase induction motor
Frame 364/5JP - IP55

27-SEP-2016

