



Dealers Industrial Equipment

No.:

Date: 27-SEP-2016

Customer :

TECHNICAL PROPOSAL

Three-phase induction motor - Squirrel cage rotor

Product line : W22 NEMA Premium - Ball Bearings

Catalog Number : 06018ET3G364T-W22

List Price : \$7,389

Notes:

Downloaded from <http://dealerselectric.com>

Generated for Model #06018ET3G364T-W22

Performed by:

Checked:



Dealers Industrial Equipment

No.:

Date: 27-SEP-2016

DATA SHEET Three-phase induction motor - Squirrel cage rotor

Customer :
 Product line : W22 NEMA Premium - Ball Bearings

Frame : 364/5T
 Output : 60 HP
 Frequency : 60 Hz
 Poles : 4
 Full load speed : 1775 rpm
 Slip : 1.39 %
 Voltage : 460 V
 Rated current : 68.3 A
 Locked rotor current : 451 A
 Locked rotor current (I_L/I_n) : 6.6
 No-load current : 24.0 A
 Full load torque : 175 lb.ft
 Locked rotor torque : 240 %
 Breakdown torque : 260 %
 Design : B
 Insulation class : F
 Temperature rise : 80 K
 Locked rotor time : 15 s (hot)
 Service factor : 1.25
 Duty cycle : S1
 Ambient temperature : -20°C - +40°C
 Altitude : 1000 m
 Degree of Protection : IP55
 Approximate weight : 869 lb
 Moment of inertia : 22.421 sq.ft.lb
 Noise level : 67 dB(A)

	D.E.	N.D.E.
Bearings	6314 C3	6314 C3
Regreasing interval	12000 h	12000 h
Grease amount	27 g	27 g

Load	Power factor	Efficiency (%)
100%	0.87	95.0
75%	0.83	94.5
50%	0.75	94.1

Notes:
 Downloaded from <http://dealerselectric.com>
 Generated for Model #06018ET3G364T-W22

Performed by

Checked



Dealers Industrial Equipment

No.:

Date: 27-SEP-2016

PERFORMANCE CURVES RELATED TO RATED OUTPUT

Three-phase induction motor - Squirrel cage rotor

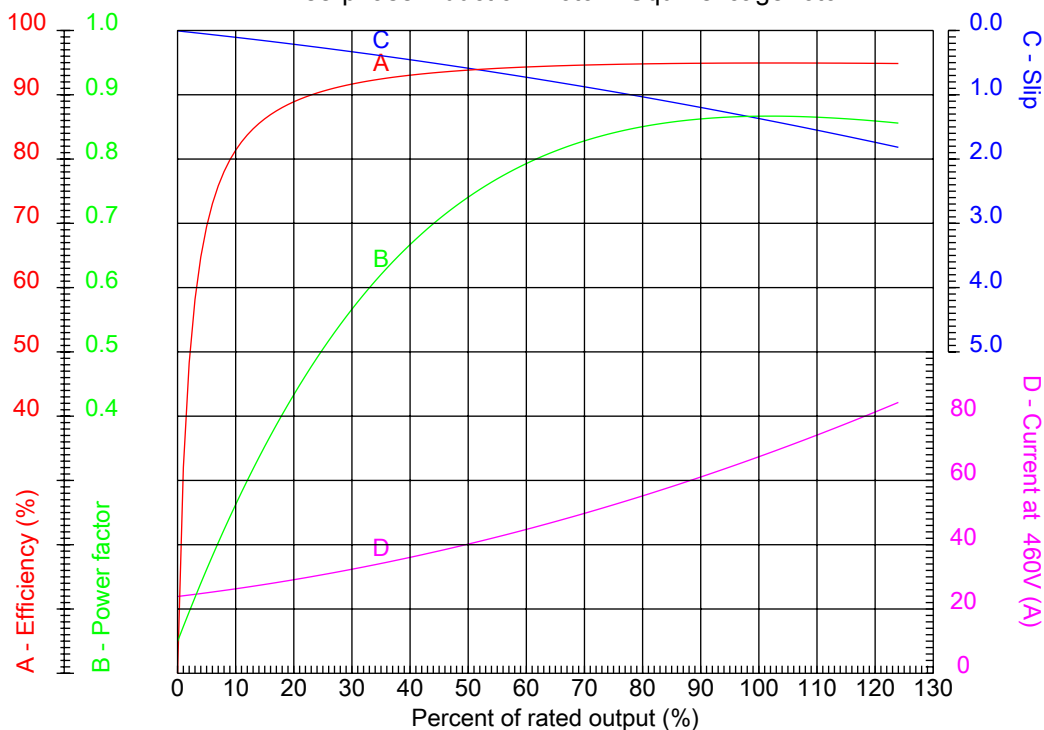

Customer :
 Product line : W22 NEMA Premium - Ball Bearings

Frame : 364/5T	Locked rotor current (I _L /I _n) : 6.6
Output : 60 HP	Duty cycle : S1
Frequency : 60 Hz	Service factor : 1.25
Full load speed : 1775 rpm	Design : B
Voltage : 460 V	Locked rotor torque : 240 %
Rated current : 68.3 A	Breakdown torque : 260 %
Insulation class : F	

Notes:
 Downloaded from <http://dealerselectric.com>
 Generated for Model #06018ET3G364T-W22

Performed by

Checked



Dealers Industrial Equipment

No.:

Date: 27-SEP-2016

CHARACTERISTIC CURVES RELATED TO SPEED

Three-phase induction motor - Squirrel cage rotor

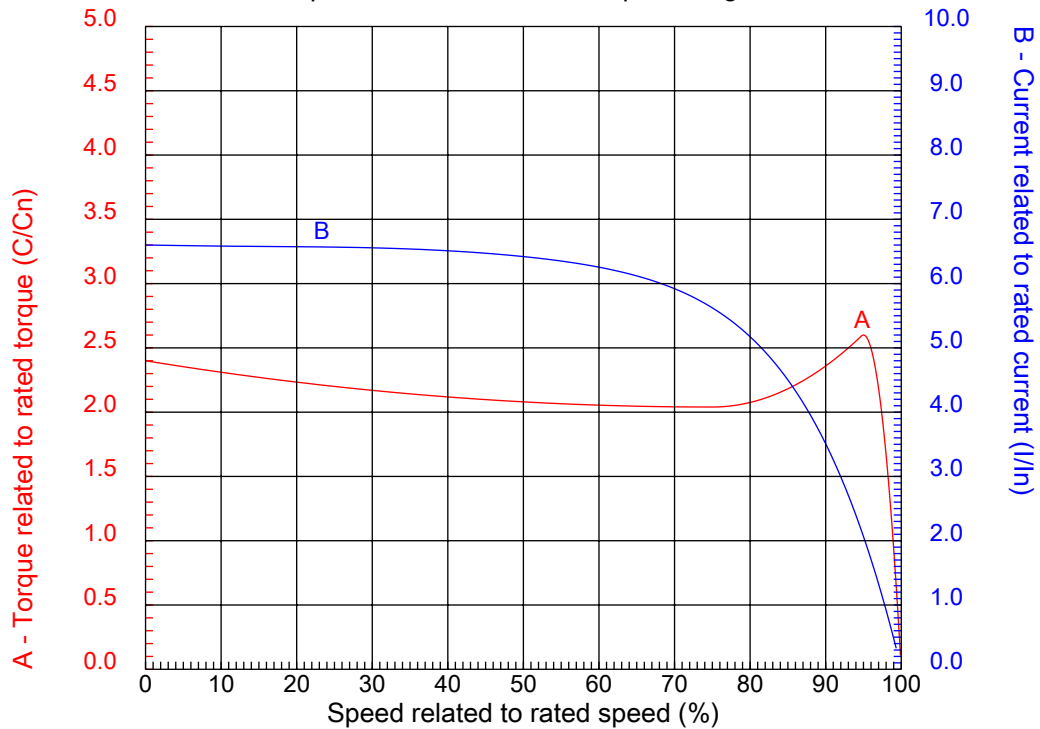

Customer :
Product line : W22 NEMA Premium - Ball Bearings

Frame	: 364/5T	Locked rotor current (I _l /I _n)	: 6.6
Output	: 60 HP	Duty cycle	: S1
Frequency	: 60 Hz	Service factor	: 1.25
Full load speed	: 1775 rpm	Design	: B
Voltage	: 460 V	Locked rotor torque	: 240 %
Rated current	: 68.3 A	Breakdown torque	: 260 %
Insulation class	: F		

Notes:
Downloaded from <http://dealerselectric.com>
Generated for Model #06018ET3G364T-W22

Performed by

Checked

1 2 3 4 5 6 7 8

A

B

C

D

E

F

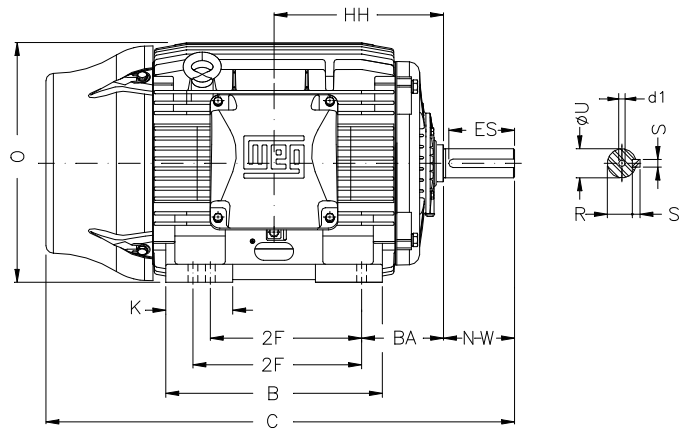

Notes: Downloaded from <http://dealerselectric.com>
Generated for Model #06018ET3G364T-W22

Performed by:

Checked:

Customer:

W22 NEMA Premium - Ball Bearings

Three-phase induction motor
Frame 364/5T - IP55

27-SEP-2016



2E 14.016	J 3.150	A 17.165	P 17.914	AB 16.016
2F 11.260/12.244	K 4.138	B 16.220	BA 5.875	FBA 11.708
U 2.375	N-W 5.874	ES 4.330	S 0.625	R 2.019
depth 0.625	D 9.000	G 1.480	HB 4.251	O 17.957
HH 11.988	HK 6.024	EV 1.634	H 0.660	C 34.251
FC 39.339	LL 10.591	LM 11.267	AA NPT 3"	d1 DUNC 3/4"-10

1 2 3 4 5 6 7 8

A

PART-WINDING

WYE-DELTA

START

RUN

START

RUN

B

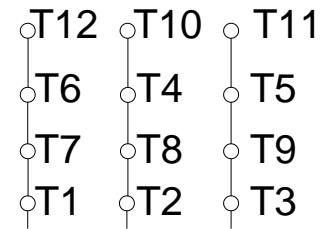
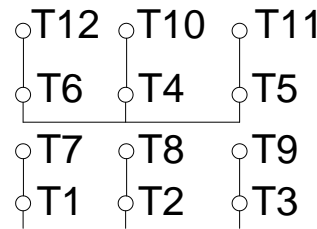
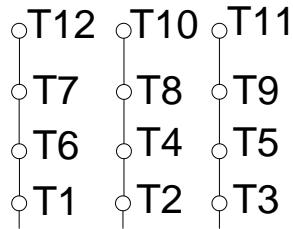
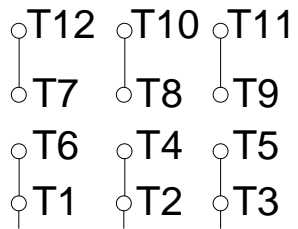

C

L1 L2 L3

L1 L2 L3

L1 L2 L3

L1 L2 L3

D

E

F

Notes: Downloaded from <http://dealerselectric.com>
 Generated for Model #06018ET3G364T-W22

Performed by:

Checked:

Customer:

W22 NEMA Premium - Ball Bearings

Three-phase induction motor
Frame 364/5T - IP55

27-SEP-2016

