



Dealers Industrial Equipment

No.:

Date: 27-SEP-2016

Customer :

TECHNICAL PROPOSAL

Three-phase induction motor - Squirrel cage rotor

Product line : Three-Phase: W22 IEEE-841™ Petrochem Motors - NEMA Premium® Efficiency

Catalog Number : 05036ST3HIE326TS-W22

List Price : \$5,970

Notes:

Downloaded from <http://dealerselectric.com>

Generated for Model #05036ST3HIE326TS-W22

Performed by:

Checked:



# Dealers Industrial Equipment

No.:

Date: 27-SEP-2016

## DATA SHEET

### Three-phase induction motor - Squirrel cage rotor

Customer :  
 Product line : Three-Phase: W22 IEEE-841™ Petrochem Motors - NEMA Premium® Efficiency

Frame : 324/6TS  
 Output : 50 HP  
 Frequency : 60 Hz  
 Poles : 2  
 Full load speed : 3550 rpm  
 Slip : 1.39 %  
 Voltage : 575 V  
 Rated current : 44.9 A  
 Locked rotor current : 278 A  
 Locked rotor current (I<sub>L</sub>/I<sub>n</sub>) : 6.2  
 No-load current : 12.0 A  
 Full load torque : 73.0 lb.ft  
 Locked rotor torque : 220 %  
 Breakdown torque : 230 %  
 Design : B  
 Insulation class : F  
 Temperature rise : 80 K  
 Locked rotor time : 23 s (hot)  
 Service factor : 1.25  
 Duty cycle : S1  
 Ambient temperature : -20°C - +40°C  
 Altitude : 1000 m  
 Degree of Protection : IP55  
 Approximate weight : 584 lb  
 Moment of inertia : 5.7469 sq.ft.lb  
 Noise level : 78 dB(A)

	D.E.	N.D.E.
Bearings	6312 C3	6212 C3
Regreasing interval	12000 h	15000 h
Grease amount	21 g	13 g

Load	Power factor	Efficiency (%)
100%	0.89	93.0
75%	0.87	93.0
50%	0.83	93.0

#### Notes:

Downloaded from <http://dealerselectric.com>  
 Generated for Model #05036ST3HIE326TS-W22

Performed by

Checked



# Dealers Industrial Equipment

No.:

Date: 27-SEP-2016

## PERFORMANCE CURVES RELATED TO RATED OUTPUT

Three-phase induction motor - Squirrel cage rotor

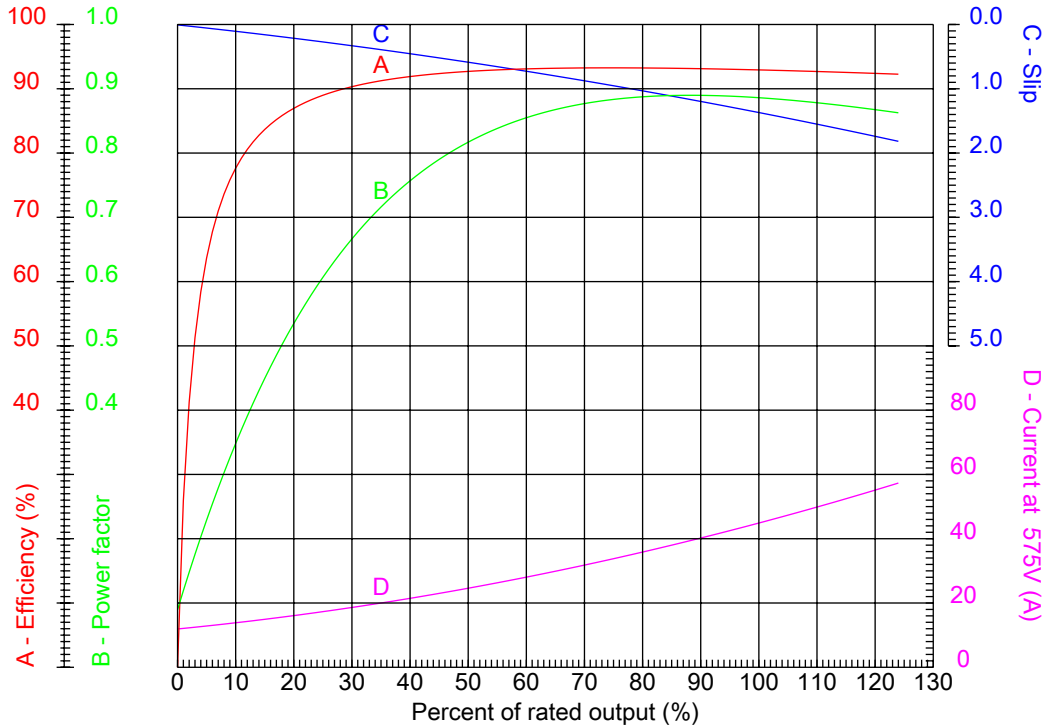

Customer :  
 Product line : Three-Phase: W22 IEEE-841™ Petrochem Motors - NEMA Premium® Efficiency

Frame	: 324/6TS	Locked rotor current (I <sub>L</sub> /I <sub>n</sub> )	: 6.2
Output	: 50 HP	Duty cycle	: S1
Frequency	: 60 Hz	Service factor	: 1.25
Full load speed	: 3550 rpm	Design	: B
Voltage	: 575 V	Locked rotor torque	: 220 %
Rated current	: 44.9 A	Breakdown torque	: 230 %
Insulation class	: F		

Notes:  
 Downloaded from <http://dealerselectric.com>  
 Generated for Model #05036ST3HIE326TS-W22

Performed by

Checked



# Dealers Industrial Equipment

No.:

Date: 27-SEP-2016

## CHARACTERISTIC CURVES RELATED TO SPEED

Three-phase induction motor - Squirrel cage rotor

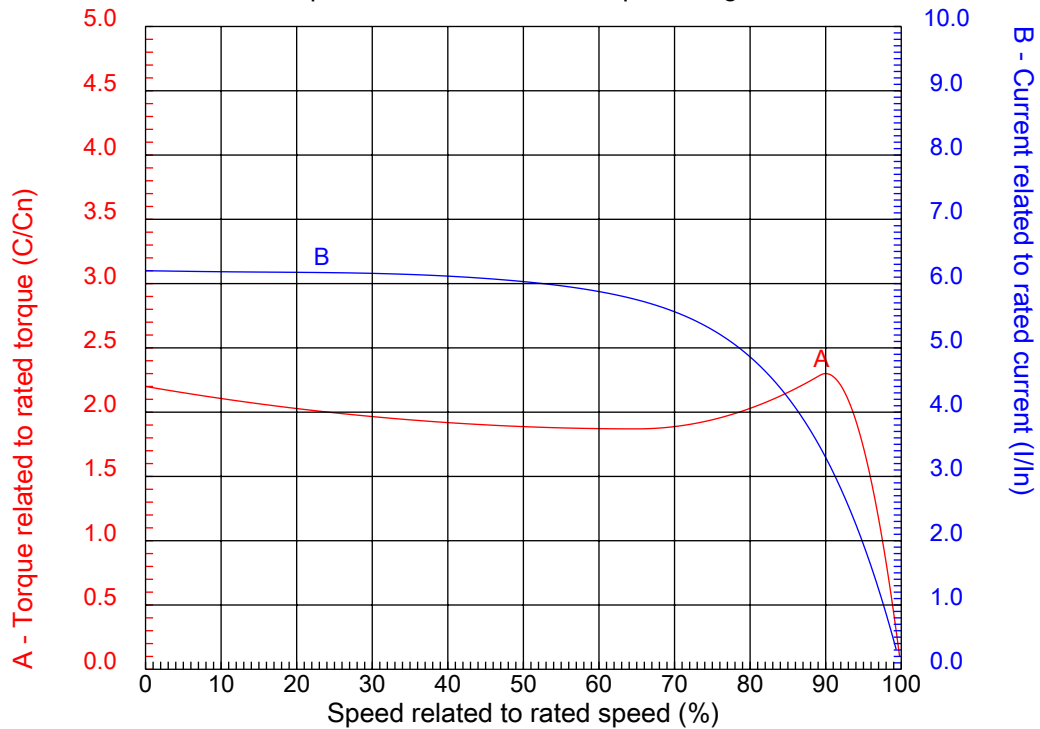

Customer :  
Product line : Three-Phase: W22 IEEE-841™ Petrochem Motors - NEMA Premium® Efficiency

Frame	: 324/6TS	Locked rotor current (I <sub>l</sub> /I <sub>n</sub> )	: 6.2
Output	: 50 HP	Duty cycle	: S1
Frequency	: 60 Hz	Service factor	: 1.25
Full load speed	: 3550 rpm	Design	: B
Voltage	: 575 V	Locked rotor torque	: 220 %
Rated current	: 44.9 A	Breakdown torque	: 230 %
Insulation class	: F		

Notes:  
Downloaded from <http://dealerselectric.com>  
Generated for Model #05036ST3HIE326TS-W22

Performed by

Checked

1 2 3 4 5 6 7 8

A

B

C

D

E

F

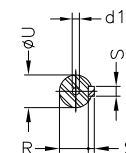
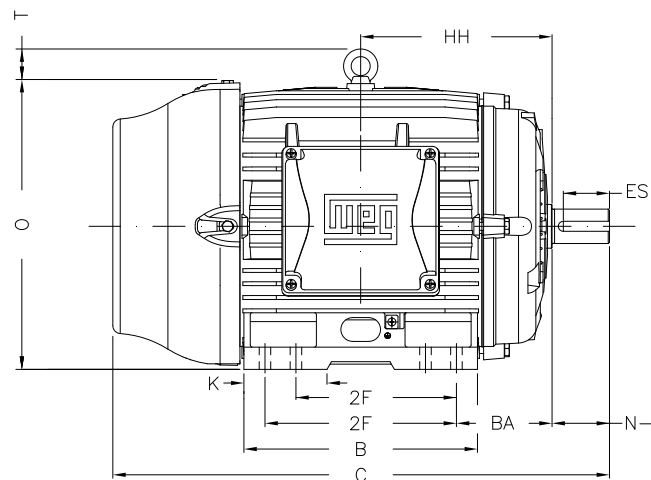
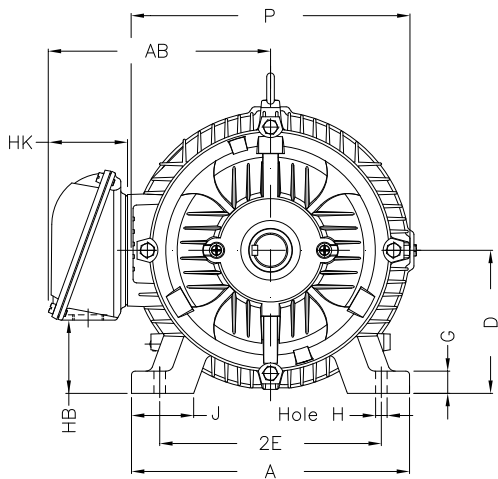
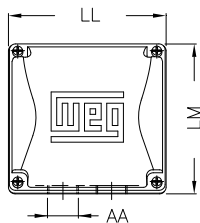

Notes: Downloaded from <http://dealerselectric.com>  
Generated for Model #05036ST3HIE326TS-W22

Performed by:

Checked:

Customer:

Three-Phase: W22 IEEE-841™ Petrochem Motors - NEMA Premium® Efficiency

Three-phase induction motor  
Frame 324/6TS - IP55

27-SEP-2016



2E 12.500	J 3.189	A 15.157	P 15.827	AB 12.575
2F 10.500/12.000	K 4.055	B 14.567	BA 5.250	U 1.875
N-W 3.750	ES 2.205	S 0.500	R 1.594	depth 0.500
D 8.000	G 1.300	HB 4.811	O 15.953	T 2.441
HF 8.708	HH 11.250	HK 4.705	H 0.657	C 29.616
LL 9.055	LM 8.661	AA NPT 2"	d1 A 4	d2 A 4

1 2 3 4 5 6 7 8

A

B

C

D

E

F



Notes: Downloaded from <http://dealerselectric.com>  
Generated for Model #05036ST3HIE326TS-W22

Performed by:

Checked:

Customer:

Three-Phase: W22 IEEE-841™ Petrochem Motors - NEMA Premium® Efficiency

Three-phase induction motor  
Frame 324/6TS - IP55

27-SEP-2016

