



Dealers Industrial Equipment

No.:

Date: 23-SEP-2016

Customer :

TECHNICAL PROPOSAL

Three-phase induction motor - Squirrel cage rotor

Product line : Close Coupled Pump: Three-Phase - W22 "JP" Type - TEFC - NEMA Premium

Catalog Number : 05018ET3H326JP-W22

List Price : \$6,624

Notes:

Downloaded from <http://dealerselectric.com>

Generated for Model #05018ET3H326JP-W22

Performed by:

Checked:



Dealers Industrial Equipment

No.:

Date: 23-SEP-2016

DATA SHEET Three-phase induction motor - Squirrel cage rotor

Customer :
 Product line : Close Coupled Pump: Three-Phase - W22 "JP" Type - TEFC - NEMA Premium

Frame : 324/6JP
 Output : 50 HP
 Frequency : 60 Hz
 Poles : 4
 Full load speed : 1775 rpm
 Slip : 1.39 %
 Voltage : 575 V
 Rated current : 47.4 A
 Locked rotor current : 294 A
 Locked rotor current (I_L/I_n) : 6.2
 No-load current : 18.8 A
 Full load torque : 146 lb.ft
 Locked rotor torque : 230 %
 Breakdown torque : 270 %
 Design : B
 Insulation class : F
 Temperature rise : 80 K
 Locked rotor time : 15 s (hot)
 Service factor : 1.25
 Duty cycle : S1
 Ambient temperature : -20°C - +40°C
 Altitude : 1000 m
 Degree of Protection : IP55
 Approximate weight : 536 lb
 Moment of inertia : 9.1624 sq.ft.lb
 Noise level : 66 dB(A)

	D.E.	N.D.E.	Load	Power factor	Efficiency (%)
Bearings	6312 C3	6212 C3	100%	0.83	94.5
Regreasing interval	20000 h	20000 h	75%	0.77	94.1
Grease amount	21 g	13 g	50%	0.66	93.0

Notes:
 Downloaded from <http://dealerselectric.com>
 Generated for Model #05018ET3H326JP-W22

Performed by

Checked



Dealers Industrial Equipment

No.:

Date: 23-SEP-2016

PERFORMANCE CURVES RELATED TO RATED OUTPUT

Three-phase induction motor - Squirrel cage rotor

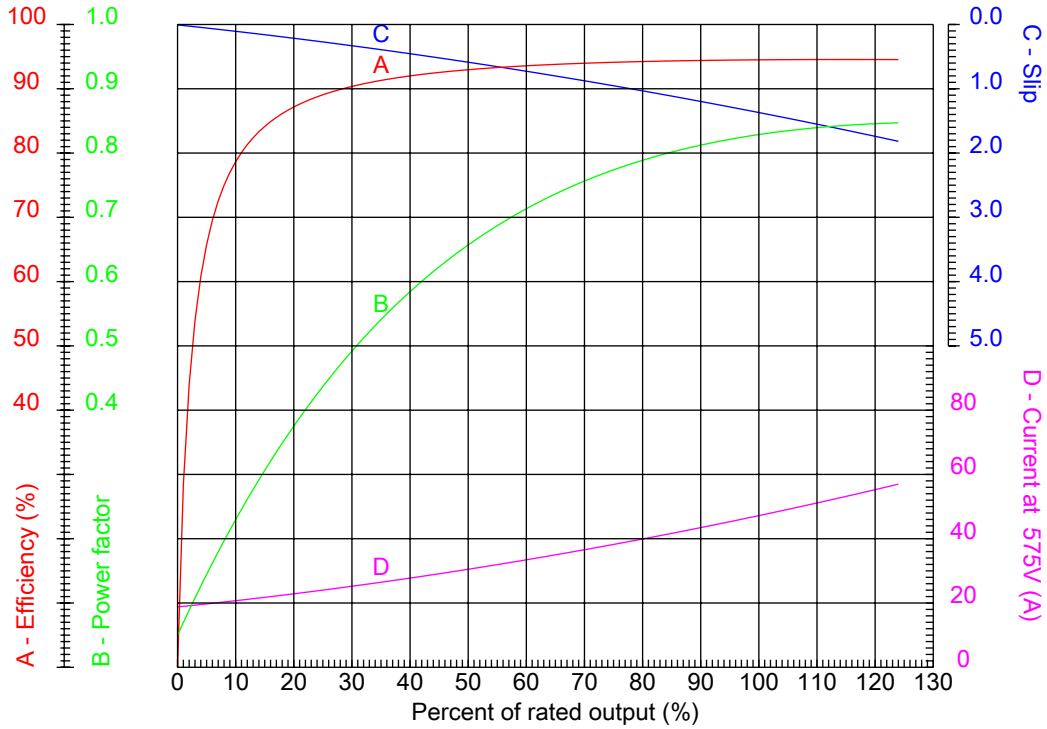

Customer :
 Product line : Close Coupled Pump: Three-Phase - W22 "JP" Type - TEFC - NEMA Premium

Frame : 324/6JP	Locked rotor current (I _l /I _n) : 6.2
Output : 50 HP	Duty cycle : S1
Frequency : 60 Hz	Service factor : 1.25
Full load speed : 1775 rpm	Design : B
Voltage : 575 V	Locked rotor torque : 230 %
Rated current : 47.4 A	Breakdown torque : 270 %
Insulation class : F	

Notes:
 Downloaded from <http://dealerselectric.com>
 Generated for Model #05018ET3H326JP-W22

Performed by

Checked



Dealers Industrial Equipment

No.:

Date: 23-SEP-2016

CHARACTERISTIC CURVES RELATED TO SPEED

Three-phase induction motor - Squirrel cage rotor

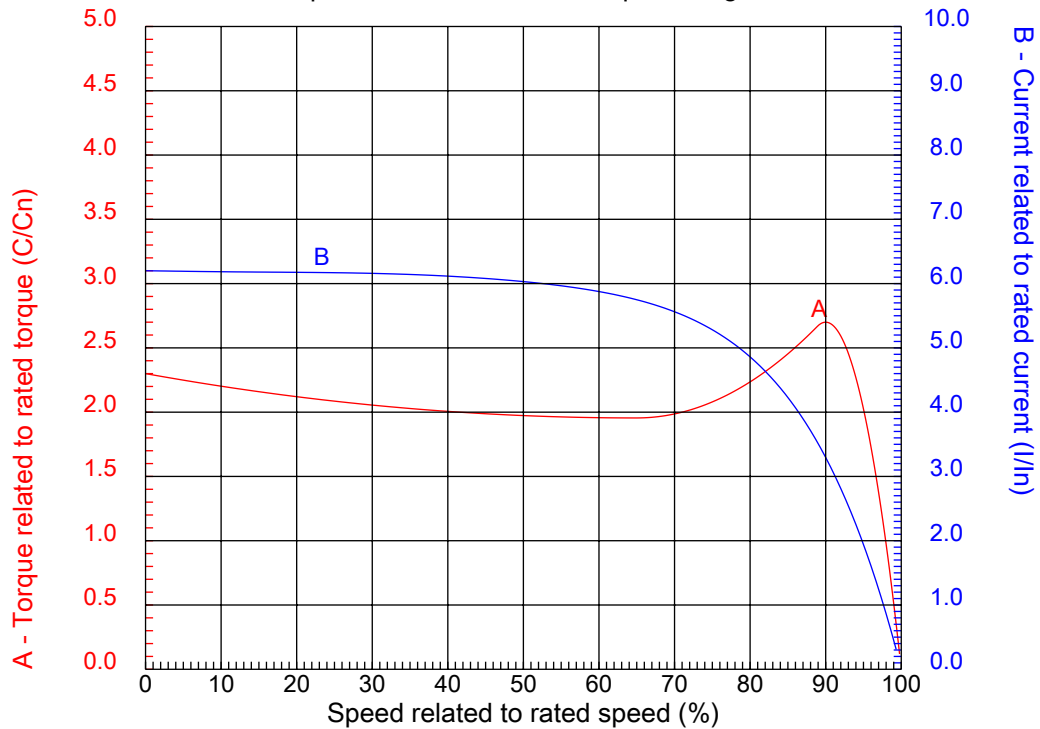

Customer :
Product line : Close Coupled Pump: Three-Phase - W22 "JP" Type - TEFC - NEMA Premium

Frame	: 324/6JP	Locked rotor current (I _l /I _n)	: 6.2
Output	: 50 HP	Duty cycle	: S1
Frequency	: 60 Hz	Service factor	: 1.25
Full load speed	: 1775 rpm	Design	: B
Voltage	: 575 V	Locked rotor torque	: 230 %
Rated current	: 47.4 A	Breakdown torque	: 270 %
Insulation class	: F		

Notes:
Downloaded from <http://dealerselectric.com>
Generated for Model #05018ET3H326JP-W22

Performed by

Checked

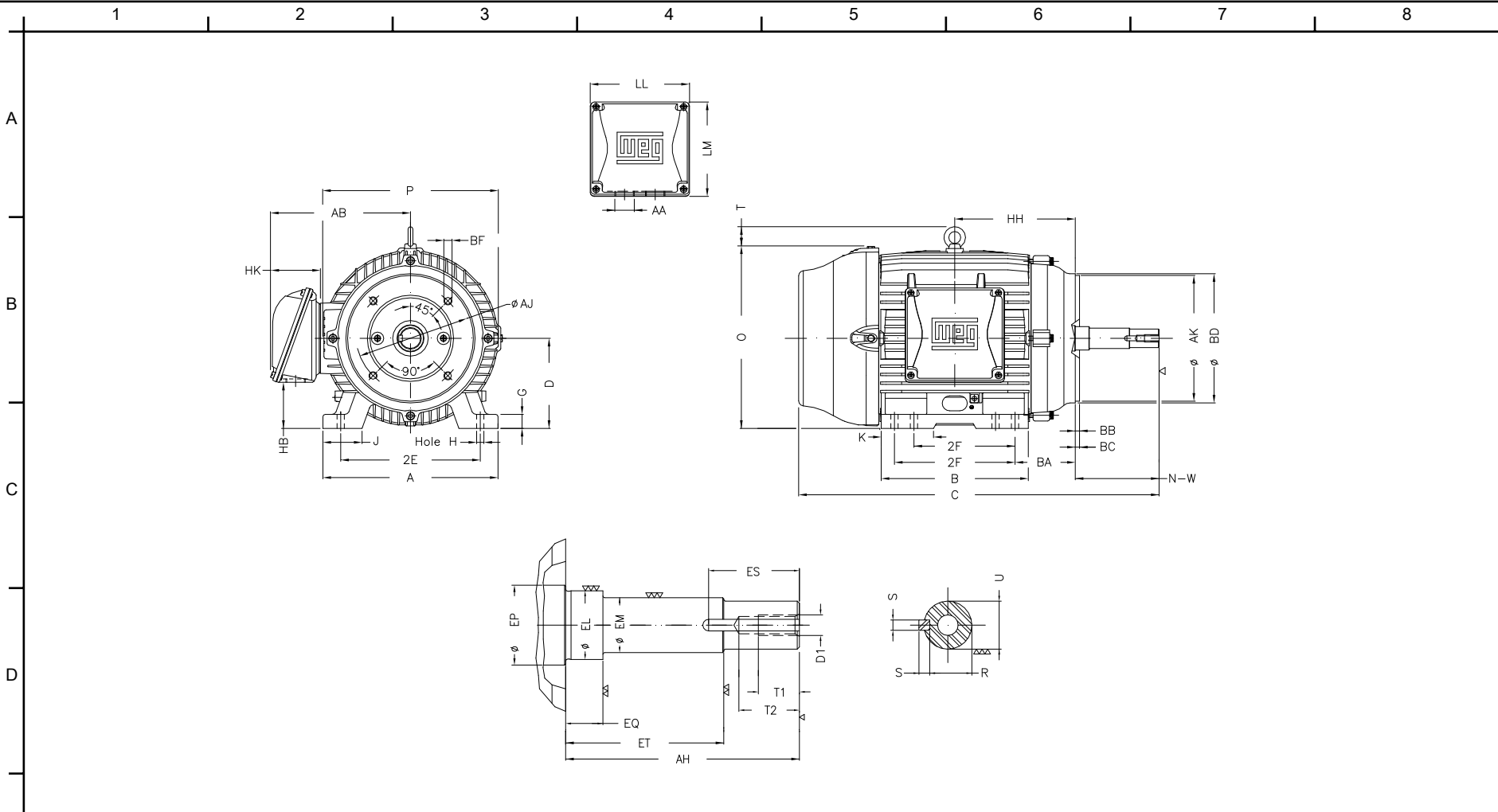

Notes: Downloaded from <http://dealerselectric.com>
 Generated for Model #05018ET3H326JP-W22

2E	J	A	P	AB
12.500	3.189	15.157	15.827	12.575
2F	K	B	BA	D
10.500/12.000	4.055	14.567	5.250	8.000
G	O	T	H	AA
1.300	15.953	2.441	0.657	NPT 2"
EQ	ET	U	EM	EL
2.402	5.906	1.249	1.375	1.750
EP	ES	t1	t2	C
2.360	2.480	1.102	1.476	34.021
d1	HH	HK	HB	LL
EUNC 1/2"-13	11.250	4.705	4.811	9.055
LM	S	R	Flange	AJ
8.661	0.250	1.110	FC-279	11.000
AK	BD	BF	BB	AH
12.500	13.593	UNC 5/8"x11	0.248	8.130

Performed by:

Checked:

Customer:

Close Coupled Pump: Three-Phase - W22 "JP" Type - TEFC - NEMA Premium

Three-phase induction motor
 Frame 324/6JP - IP55

23-SEP-2016



1 2 3 4 5 6 7 8

A

B

C

D

E

F



Notes: Downloaded from <http://dealerselectric.com>
Generated for Model #05018ET3H326JP-W22

Performed by:

Checked:

Customer:

Close Coupled Pump: Three-Phase - W22 "JP" Type - TEFC - NEMA Premium

Three-phase induction motor
Frame 324/6JP - IP55

23-SEP-2016

