



Dealers Industrial Equipment

No.:

Date: 23-SEP-2016

Customer :

TECHNICAL PROPOSAL

Three-phase induction motor - Squirrel cage rotor

Product line : ODP General Purpose

Catalog Number : 04036OT3E286TS-G

List Price : \$3,618

Notes:

Downloaded from <http://dealerselectric.com>

Generated for Model #04036OT3E286TS-G

Performed by:

Checked:



Dealers Industrial Equipment

No.:

Date: 23-SEP-2016

DATA SHEET Three-phase induction motor - Squirrel cage rotor

Customer :
Product line : ODP General Purpose

Frame : 286TS
Output : 40 HP
Frequency : 60 Hz
Poles : 2
Full load speed : 3535 rpm
Slip : 1.81 %
Voltage : 208-230/460 V
Rated current : 104-94.2/47.1 A
Locked rotor current : 603/301 A
Locked rotor current (I_L/I_n) : 6.4
No-load current : 26.0/13.0 A
Full load torque : 58.6 lb.ft
Locked rotor torque : 200 %
Breakdown torque : 260 %
Design : B
Insulation class : F
Temperature rise : 80 K
Locked rotor time : 10 s (hot)
Service factor : 1.15
Duty cycle : S1
Ambient temperature : -20°C - +40°C
Altitude : 1000 m
Degree of Protection : IP23
Approximate weight : 357 lb
Moment of inertia : 2.3569 sq.ft.lb
Noise level : 73 dB(A)

	D.E.	N.D.E.
Bearings	6311 Z-C3	6211 Z-C3
Regreasing interval	20000 h	20000 h
Grease amount	18 g	11 g

Load	Power factor	Efficiency (%)
100%	0.86	93.0
75%	0.83	93.0
50%	0.74	91.7

Notes:
Downloaded from <http://dealerselectric.com>
Generated for Model #04036OT3E286TS-G

Performed by

Checked



Dealers Industrial Equipment

No.:

Date: 23-SEP-2016

PERFORMANCE CURVES RELATED TO RATED OUTPUT

Three-phase induction motor - Squirrel cage rotor

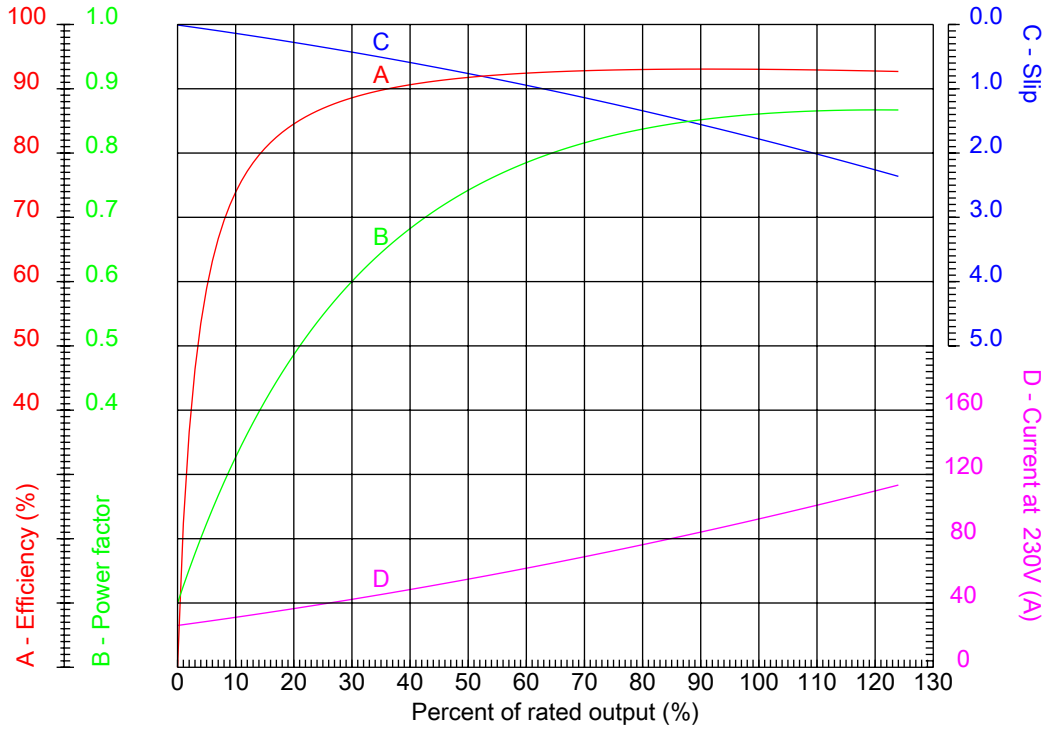

Customer :
Product line : ODP General Purpose

Frame	: 286TS	Locked rotor current (I _l /I _n)	: 6.4
Output	: 40 HP	Duty cycle	: S1
Frequency	: 60 Hz	Service factor	: 1.15
Full load speed	: 3535 rpm	Design	: B
Voltage	: 208-230/460 V	Locked rotor torque	: 200 %
Rated current	: 104-94.2/47.1 A	Breakdown torque	: 260 %
Insulation class	: F		

Notes:
Downloaded from <http://dealerselectric.com>
Generated for Model #04036OT3E286TS-G

Performed by

Checked



CHARACTERISTIC CURVES RELATED TO SPEED

Three-phase induction motor - Squirrel cage rotor

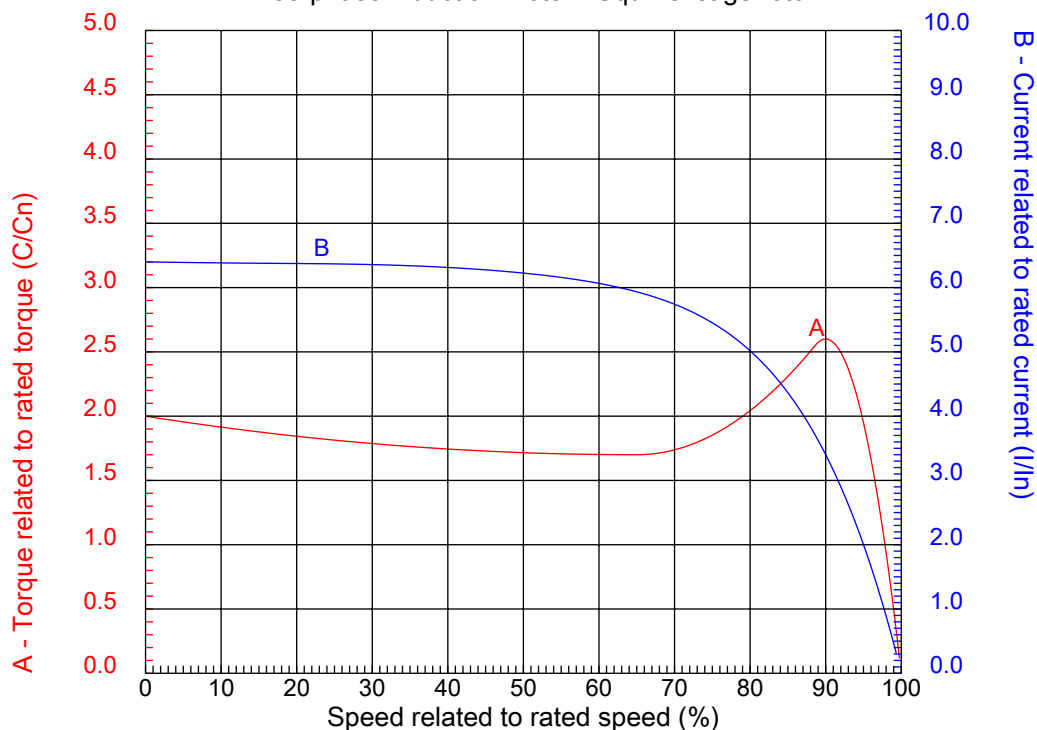

Customer :
Product line : ODP General Purpose

Frame	: 286TS	Locked rotor current (I _l /I _n)	: 6.4
Output	: 40 HP	Duty cycle	: S1
Frequency	: 60 Hz	Service factor	: 1.15
Full load speed	: 3535 rpm	Design	: B
Voltage	: 208-230/460 V	Locked rotor torque	: 200 %
Rated current	: 104-94.2/47.1 A	Breakdown torque	: 260 %
Insulation class	: F		

Notes:
Downloaded from <http://dealerselectric.com>
Generated for Model #04036OT3E286TS-G

Performed by

Checked

1 2 3 4 5 6 7 8

A

B

C

D

E

F

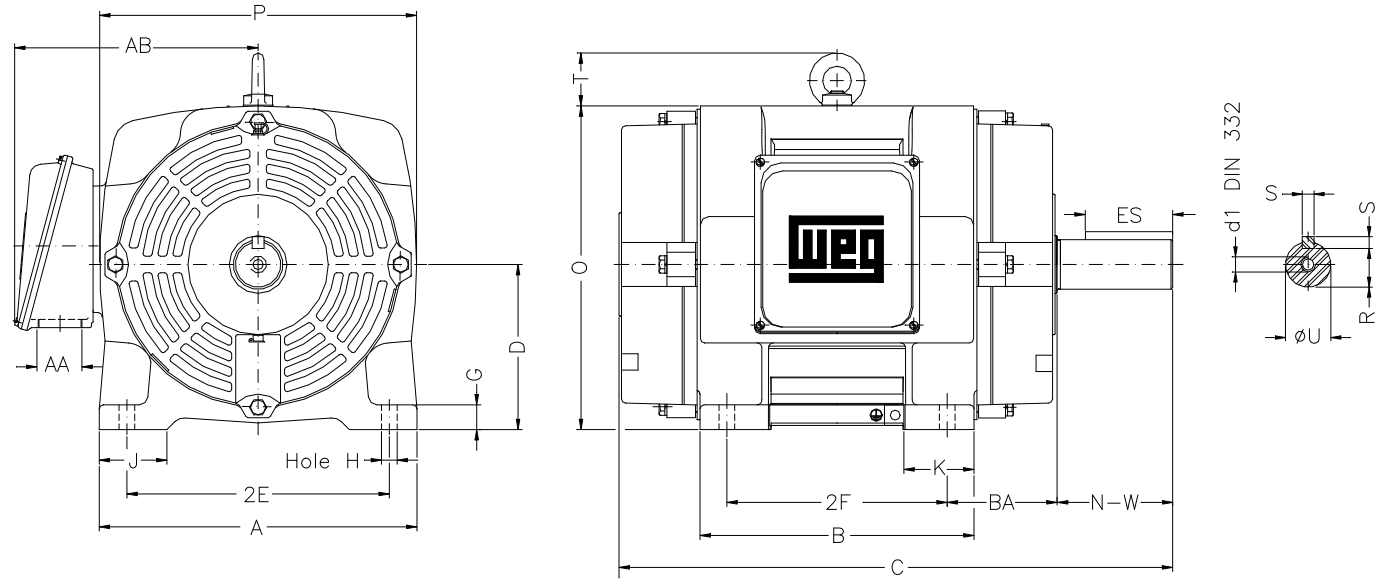

Notes: Downloaded from <http://dealerselectric.com>
Generated for Model #040360T3E286TS-G

Performed by:

Checked:

Customer:

ODP General Purpose

Three-phase induction motor
Frame 286TS - IP23

23-SEP-2016



2E 11.000	A 13.780	2F 11.000	B 13.070	BA 4.750
J 3.150	K 2.960	P 13.700	ES 2.480	depth 0.375
S 0.375	D 7.000	N-W 3.250	G 1.102	U 1.625
O 13.858	T 2.165	R 1.416	H 0.531	AB 10.886
C 23.504	AA NPT 1 1/2"	d1 A 4		

1 2 3 4 5 6 7 8

A
B
C
D
E
F

LOW VOLTAGE

HIGH VOLTAGE

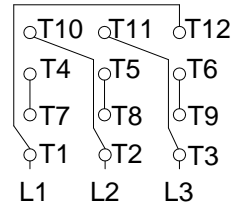
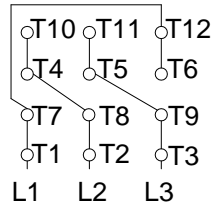

CONNECTIONS FOR STARTING ONLY:

LOW VOLTAGE

HIGH VOLTAGE

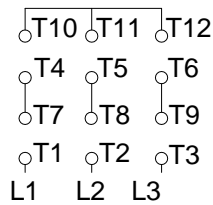
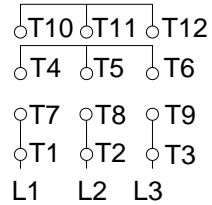

Notes: Downloaded from <http://dealerselectric.com>
Generated for Model #040360T3E286TS-G

Performed by:

Checked:

Customer:

ODP General Purpose

Three-phase induction motor
Frame 286TS - IP23

23-SEP-2016

