



# Dealers Industrial Equipment

No.:

Date: 23-SEP-2016

Customer :

## TECHNICAL PROPOSAL

### Three-phase induction motor - Squirrel cage rotor

Product line : ODP – Open Induction Motors – NEMA Premium Efficiency

Catalog Number : 04018OT3E324TS

List Price : \$3,095

#### Notes:

Downloaded from <http://dealerselectric.com>

Generated for Model #04018OT3E324TS

Performed by:

Checked:



# Dealers Industrial Equipment

No.:

Date: 23-SEP-2016

## DATA SHEET Three-phase induction motor - Squirrel cage rotor

Customer :  
 Product line : ODP – Open Induction Motors – NEMA Premium Efficiency

Frame : 324TS  
 Output : 40 HP  
 Frequency : 60 Hz  
 Poles : 4  
 Full load speed : 1775 rpm  
 Slip : 1.39 %  
 Voltage : 208-230/460 V  
 Rated current : 107-96.4/48.2 A  
 Locked rotor current : 598/299 A  
 Locked rotor current (I<sub>L</sub>/I<sub>n</sub>) : 6.2  
 No-load current : 37.0/18.5 A  
 Full load torque : 117 lb.ft  
 Locked rotor torque : 220 %  
 Breakdown torque : 230 %  
 Design : B  
 Insulation class : F  
 Temperature rise : 80 K  
 Locked rotor time : 28 s (hot)  
 Service factor : 1.15  
 Duty cycle : S1  
 Ambient temperature : -20°C - +40°C  
 Altitude : 1000 m  
 Degree of Protection : IP23  
 Approximate weight : 507 lb  
 Moment of inertia : 6.0540 sq.ft.lb  
 Noise level : 64 dB(A)

	D.E.	N.D.E.
Bearings	6312 Z-C3	6212 Z-C3
Regreasing interval	20000 h	20000 h
Grease amount	21 g	13 g

Load	Power factor	Efficiency (%)
100%	0.83	94.1
75%	0.78	94.1
50%	0.68	93.6

Notes:  
 Downloaded from <http://dealerselectric.com>  
 Generated for Model #04018OT3E324TS

Performed by

Checked



# Dealers Industrial Equipment

No.:

Date: 23-SEP-2016

## PERFORMANCE CURVES RELATED TO RATED OUTPUT

Three-phase induction motor - Squirrel cage rotor

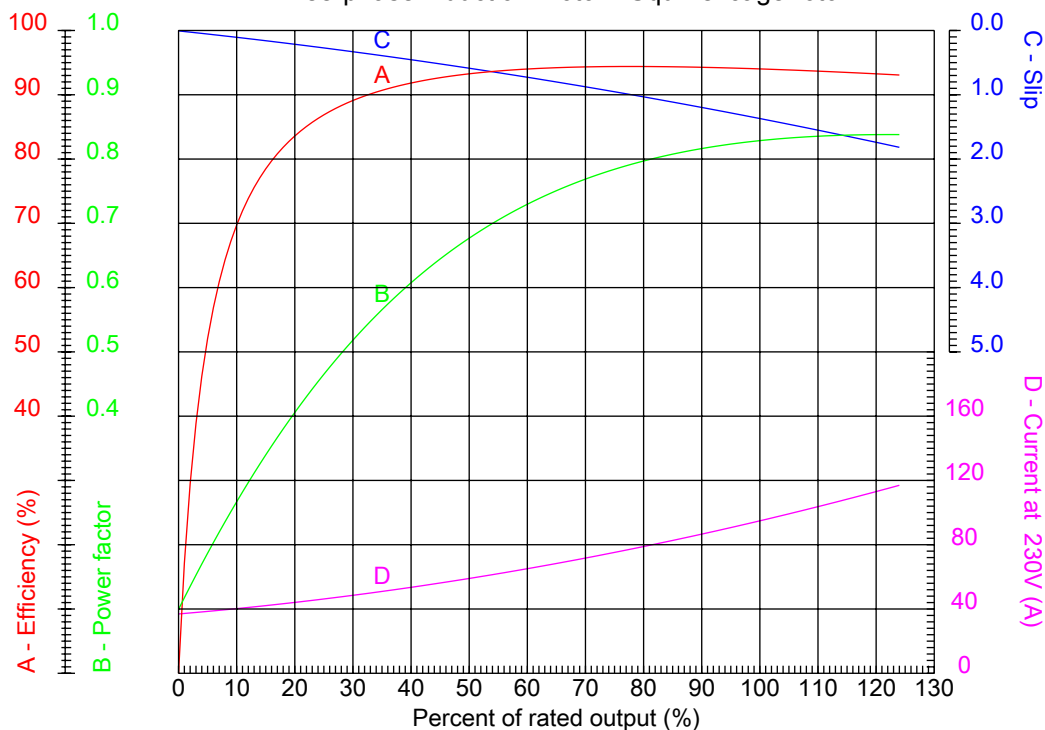

Customer :  
 Product line : ODP – Open Induction Motors – NEMA Premium Efficiency

Frame	: 324TS	Locked rotor current (I <sub>l</sub> /I <sub>n</sub> )	: 6.2
Output	: 40 HP	Duty cycle	: S1
Frequency	: 60 Hz	Service factor	: 1.15
Full load speed	: 1775 rpm	Design	: B
Voltage	: 208-230/460 V	Locked rotor torque	: 220 %
Rated current	: 107-96.4/48.2 A	Breakdown torque	: 230 %
Insulation class	: F		

Notes:  
 Downloaded from <http://dealerselectric.com>  
 Generated for Model #04018OT3E324TS

Performed by

Checked



# Dealers Industrial Equipment

No.:

Date: 23-SEP-2016

## CHARACTERISTIC CURVES RELATED TO SPEED

Three-phase induction motor - Squirrel cage rotor

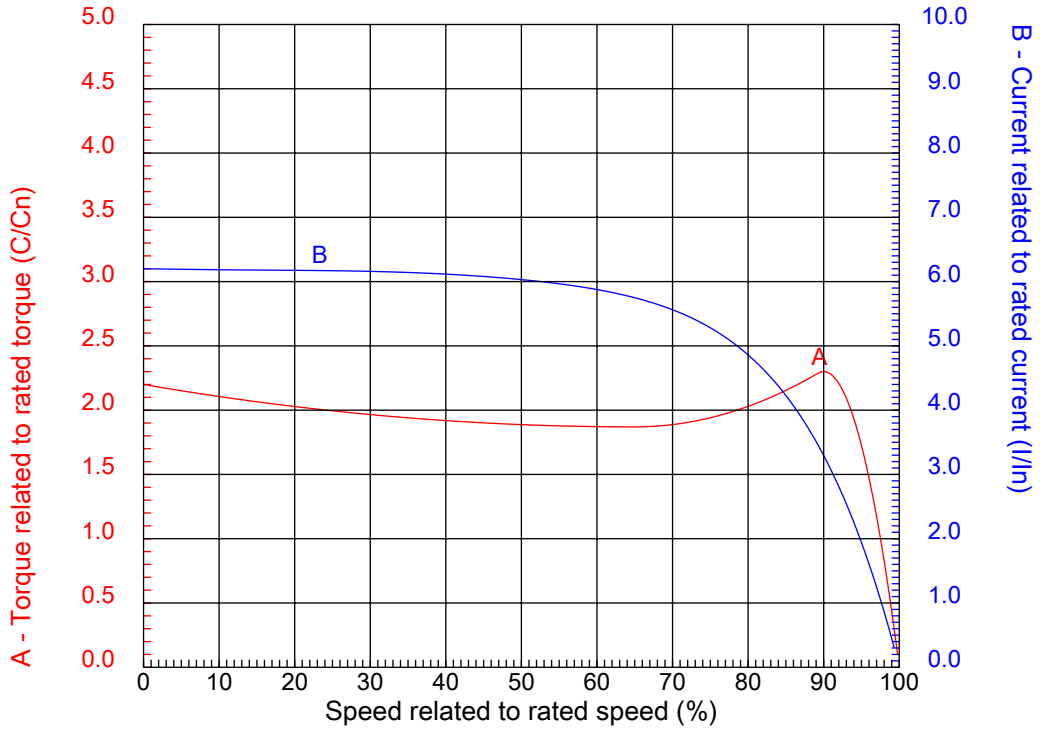

Customer :  
 Product line : ODP – Open Induction Motors – NEMA Premium Efficiency

Frame	: 324TS	Locked rotor current (I/I <sub>ln</sub> )	: 6.2
Output	: 40 HP	Duty cycle	: S1
Frequency	: 60 Hz	Service factor	: 1.15
Full load speed	: 1775 rpm	Design	: B
Voltage	: 208-230/460 V	Locked rotor torque	: 220 %
Rated current	: 107-96.4/48.2 A	Breakdown torque	: 230 %
Insulation class	: F		

Notes:  
 Downloaded from <http://dealerselectric.com>  
 Generated for Model #04018OT3E324TS

Performed by

Checked

1 2 3 4 5 6 7 8

A

B

C

D

E

F

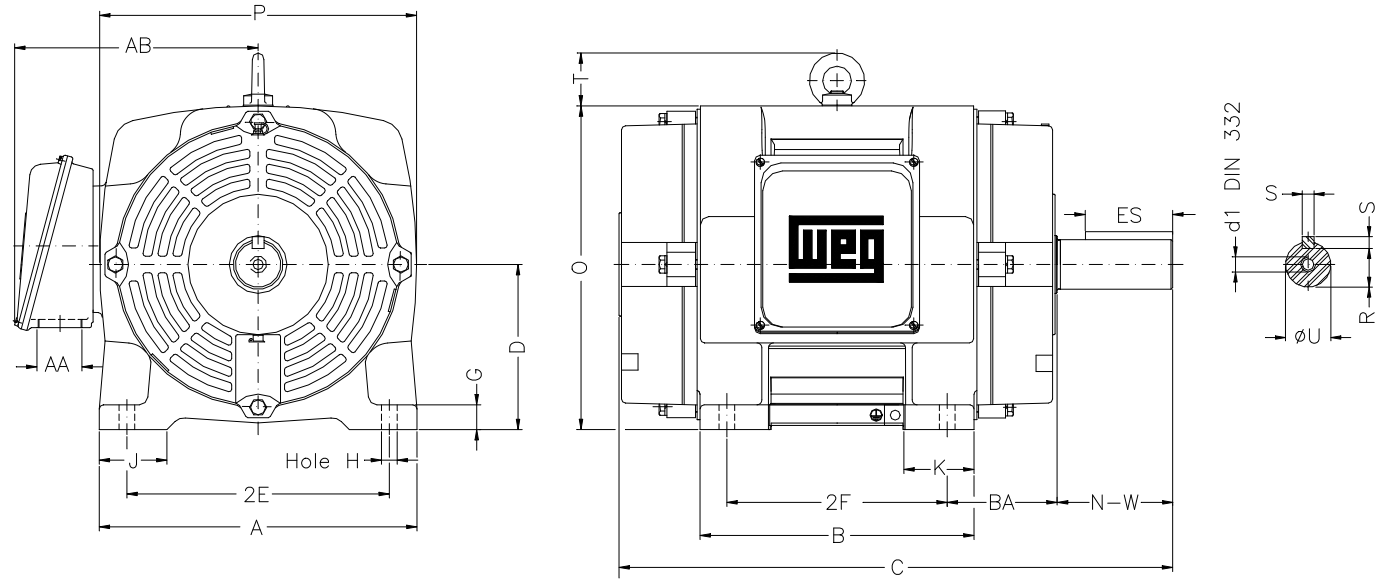

Notes: Downloaded from <http://dealerselectric.com>  
Generated for Model #04018OT3E324TS

Performed by:

Checked:

Customer:

ODP – Open Induction Motors – NEMA Premium Efficiency

Three-phase induction motor  
Frame 324TS - IP23

23-SEP-2016



2E 12.500	J 3.230	A 15.160	P 15.118	AB 11.496
2F 10.500	K 3.350	B 13.070	BA 5.250	U 1.875
d1 A 4	N-W 3.750	ES 2.756	S 0.500	R 1.594
depth 0.500	D 8.000	G 1.299	O 15.551	T 2.559
H 0.656	C 24.685	AA NPT 2"		

1 2 3 4 5 6 7 8

A  
B  
C  
D  
E  
F

LOW VOLTAGE

HIGH VOLTAGE

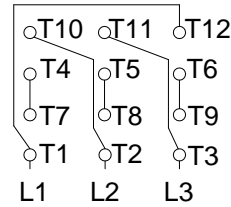
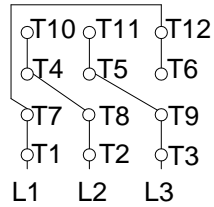

CONNECTIONS FOR STARTING ONLY:

LOW VOLTAGE

HIGH VOLTAGE

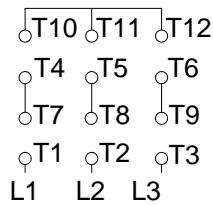
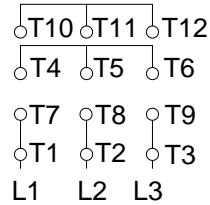

Notes: Downloaded from <http://dealerselectric.com>  
Generated for Model #04018OT3E324TS

Performed by:

Checked:

Customer:

ODP – Open Induction Motors – NEMA Premium Efficiency

Three-phase induction motor  
Frame 324TS - IP23

23-SEP-2016

