



Dealers Industrial Equipment

No.:

Date: 23-SEP-2016

Customer :

TECHNICAL PROPOSAL

Three-phase induction motor - Squirrel cage rotor

Product line : Three-Phase: W22 IEEE-841™ Petrochem Motors - NEMA Premium® Efficiency

Catalog Number : 04012ST3QIE364T-W22

List Price : \$8,636

Notes:

Downloaded from <http://dealerselectric.com>

Generated for Model #04012ST3QIE364T-W22

Performed by:

Checked:



Dealers Industrial Equipment

No.:

Date: 23-SEP-2016

DATA SHEET Three-phase induction motor - Squirrel cage rotor

Customer :
 Product line : Three-Phase: W22 IEEE-841™ Petrochem Motors - NEMA Premium® Efficiency

Frame : 364/5T
 Output : 40 HP
 Frequency : 60 Hz
 Poles : 6
 Full load speed : 1185 rpm
 Slip : 1.25 %
 Voltage : 460 V
 Rated current : 46.5 A
 Locked rotor current : 298 A
 Locked rotor current (I_L/I_n) : 6.4
 No-load current : 17.0 A
 Full load torque : 175 lb.ft
 Locked rotor torque : 200 %
 Breakdown torque : 240 %
 Design : B
 Insulation class : F
 Temperature rise : 80 K
 Locked rotor time : 21 s (hot)
 Service factor : 1.25
 Duty cycle : S1
 Ambient temperature : -20°C - +40°C
 Altitude : 1000 m
 Degree of Protection : IP55
 Approximate weight : 833 lb
 Moment of inertia : 29.040 sq.ft.lb
 Noise level : 66 dB(A)

	D.E.	N.D.E.	Load	Power factor	Efficiency (%)
Bearings	6314 C3	6314 C3	100%	0.86	94.1
Regreasing interval	17000 h	17000 h	75%	0.82	93.6
Grease amount	27 g	27 g	50%	0.73	93.6

Notes:
 Downloaded from <http://dealerselectric.com>
 Generated for Model #04012ST3QIE364T-W22

Performed by

Checked



Dealers Industrial Equipment

No.:

Date: 23-SEP-2016

PERFORMANCE CURVES RELATED TO RATED OUTPUT

Three-phase induction motor - Squirrel cage rotor

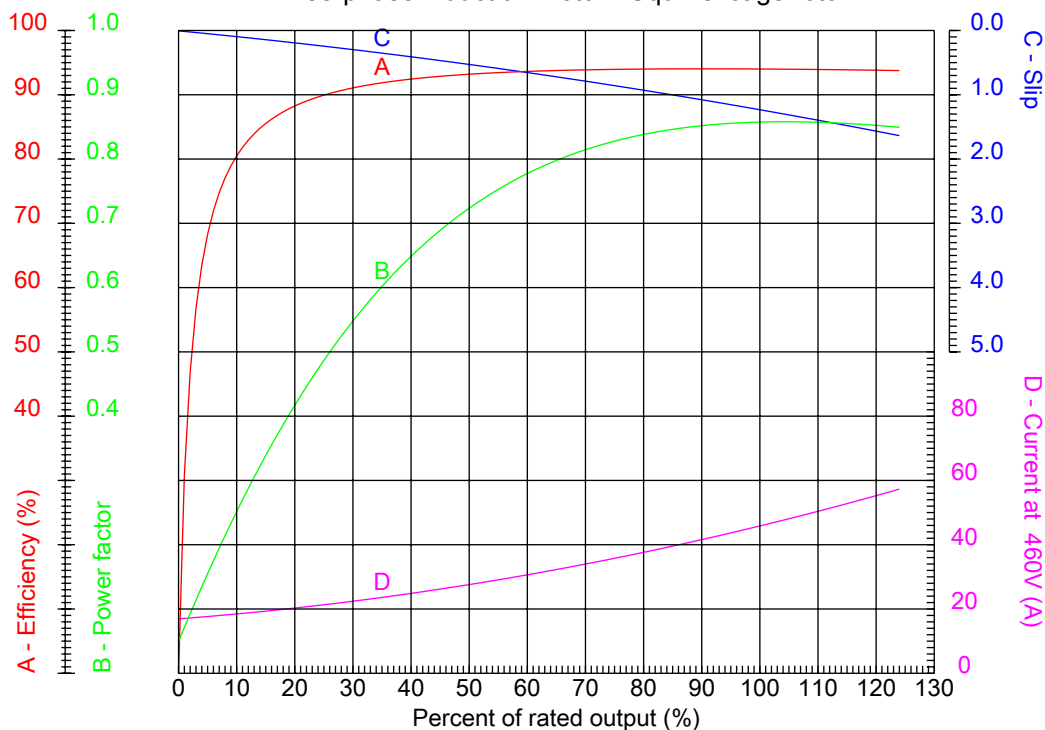

Customer :
Product line : Three-Phase: W22 IEEE-841™ Petrochem Motors - NEMA Premium® Efficiency

Frame	: 364/5T	Locked rotor current (I _L /I _n)	: 6.4
Output	: 40 HP	Duty cycle	: S1
Frequency	: 60 Hz	Service factor	: 1.25
Full load speed	: 1185 rpm	Design	: B
Voltage	: 460 V	Locked rotor torque	: 200 %
Rated current	: 46.5 A	Breakdown torque	: 240 %
Insulation class	: F		

Notes:
Downloaded from <http://dealerselectric.com>
Generated for Model #04012ST3QIE364T-W22

Performed by

Checked



Dealers Industrial Equipment

No.:

Date: 23-SEP-2016

CHARACTERISTIC CURVES RELATED TO SPEED

Three-phase induction motor - Squirrel cage rotor

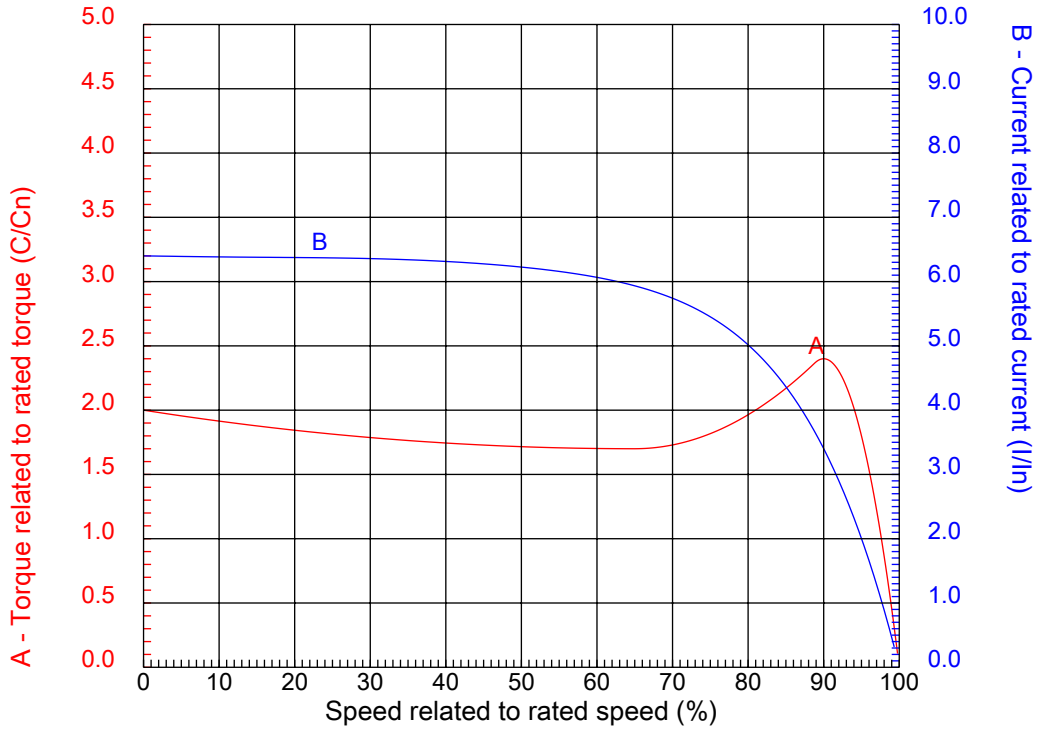

Customer	:	
Product line	:	Three-Phase: W22 IEEE-841™ Petrochem Motors - NEMA Premium® Efficiency

Frame	:	364/5T	Locked rotor current (I _l /I _n)	:	6.4
Output	:	40 HP	Duty cycle	:	S1
Frequency	:	60 Hz	Service factor	:	1.25
Full load speed	:	1185 rpm	Design	:	B
Voltage	:	460 V	Locked rotor torque	:	200 %
Rated current	:	46.5 A	Breakdown torque	:	240 %
Insulation class	:	F			

Notes:
 Downloaded from <http://dealerselectric.com>
 Generated for Model #04012ST3QIE364T-W22

Performed by

Checked

1 2 3 4 5 6 7 8

A

B

C

D

E

F

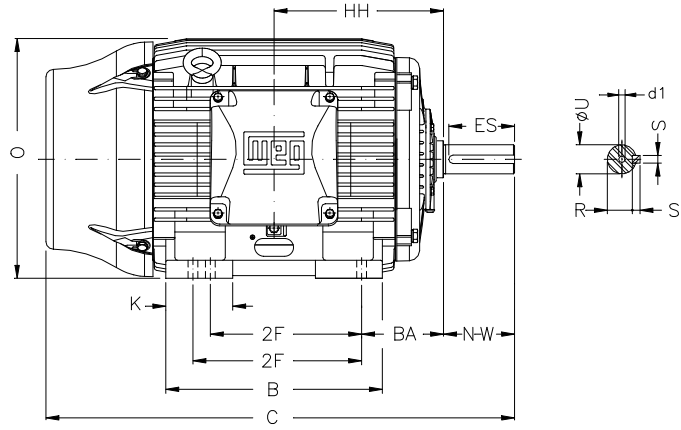
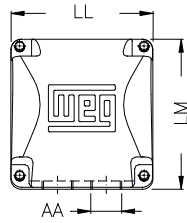

Notes: Downloaded from <http://dealerselectric.com>
Generated for Model #04012ST3QIE364T-W22

Performed by:

Checked:

Customer:

Three-Phase: W22 IEEE-841™ Petrochem Motors - NEMA Premium® Efficiency

Three-phase induction motor
Frame 364/5T - IP55

23-SEP-2016



2E 14.016	J 3.150	A 17.165	P 17.914	AB 16.016
2F 11.260/12.244	K 4.138	B 16.220	BA 5.875	U 2.375
N-W 5.874	ES 4.330	S 0.625	R 2.019	depth 0.625
D 9.000	G 1.480	HB 4.251	O 17.957	HH 11.988
HK 6.024	H 0.660	C 34.251	LL 10.591	LM 11.267
AA NPT 3"	d1 DUNC 3/4"-10	d2 DUNC 3/4"-10		

1 2 3 4 5 6 7 8

A

B

C

D

E

F



Notes: Downloaded from <http://dealerselectric.com>
Generated for Model #04012ST3QIE364T-W22

Performed by:

Checked:

Customer:

Three-Phase: W22 IEEE-841™ Petrochem Motors - NEMA Premium® Efficiency

Three-phase induction motor
Frame 364/5T - IP55

23-SEP-2016

