



Dealers Industrial Equipment

No.:

Date: 23-SEP-2016

Customer :

TECHNICAL PROPOSAL

Three-phase induction motor - Squirrel cage rotor

Product line : W22 NEMA Premium - Ball Bearings

Catalog Number : 03018ET3E286TS-W22

List Price : \$3,223

Notes:

Downloaded from <http://dealerselectric.com>

Generated for Model #03018ET3E286TS-W22

Performed by:

Checked:



Dealers Industrial Equipment

No.:

Date: 23-SEP-2016

DATA SHEET Three-phase induction motor - Squirrel cage rotor

Customer :
 Product line : W22 NEMA Premium - Ball Bearings

Frame : 284/6TS
 Output : 30 HP
 Frequency : 60 Hz
 Poles : 4
 Full load speed : 1765 rpm
 Slip : 1.94 %
 Voltage : 208-230/460 V
 Rated current : 77.6-70.2/35.1 A
 Locked rotor current : 428/214 A
 Locked rotor current (I_L/I_n) : 6.1
 No-load current : 26.0/13.0 A
 Full load torque : 88.1 lb.ft
 Locked rotor torque : 240 %
 Breakdown torque : 240 %
 Design : B
 Insulation class : F
 Temperature rise : 80 K
 Locked rotor time : 20 s (hot)
 Service factor : 1.25
 Duty cycle : S1
 Ambient temperature : -20°C - +40°C
 Altitude : 1000 m
 Degree of Protection : IP55
 Approximate weight : 437 lb
 Moment of inertia : 5.8532 sq.ft.lb
 Noise level : 64 dB(A)

	D.E.	N.D.E.
Bearings	6311 C3	6211 C3
Regreasing interval	20000 h	20000 h
Grease amount	18 g	11 g

Load	Power factor	Efficiency (%)
100%	0.84	93.6
75%	0.80	93.0
50%	0.70	93.0

Notes:
 Downloaded from <http://dealerselectric.com>
 Generated for Model #03018ET3E286TS-W22

Performed by

Checked



Dealers Industrial Equipment

No.:

Date: 23-SEP-2016

PERFORMANCE CURVES RELATED TO RATED OUTPUT

Three-phase induction motor - Squirrel cage rotor

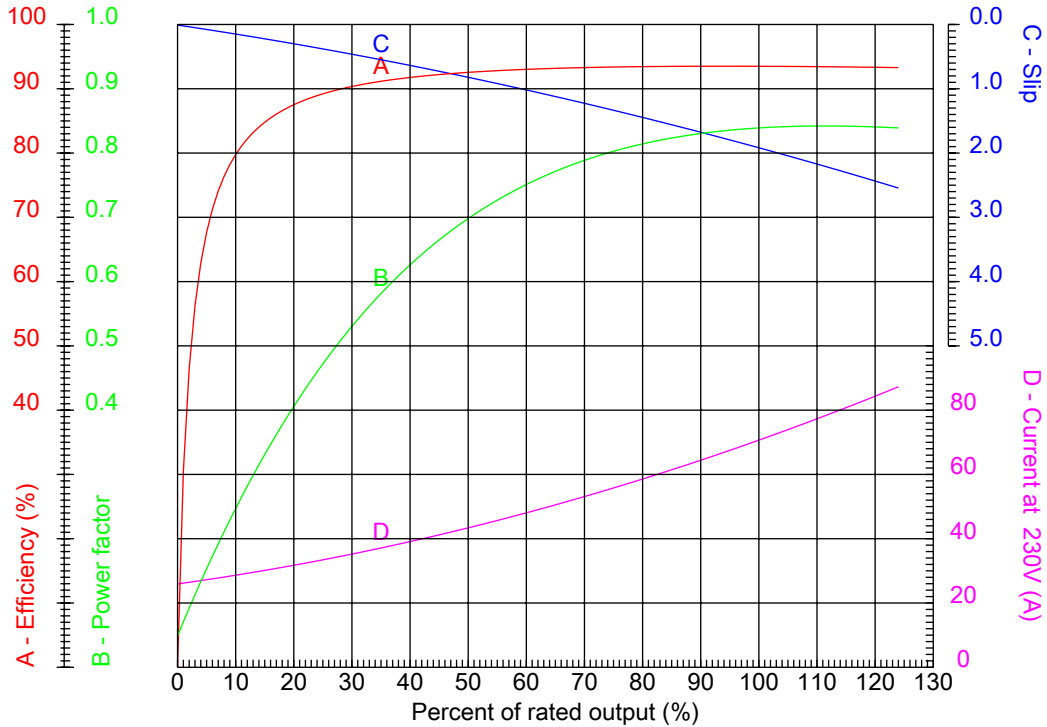

Customer :
 Product line : W22 NEMA Premium - Ball Bearings

Frame	: 284/6TS	Locked rotor current (I _l /I _n)	: 6.1
Output	: 30 HP	Duty cycle	: S1
Frequency	: 60 Hz	Service factor	: 1.25
Full load speed	: 1765 rpm	Design	: B
Voltage	: 208-230/460 V	Locked rotor torque	: 240 %
Rated current	: 77.6-70.2/35.1 A	Breakdown torque	: 240 %
Insulation class	: F		

Notes:
 Downloaded from <http://dealerselectric.com>
 Generated for Model #03018ET3E286TS-W22

Performed by

Checked



Dealers Industrial Equipment

No.:

Date: 23-SEP-2016

CHARACTERISTIC CURVES RELATED TO SPEED

Three-phase induction motor - Squirrel cage rotor

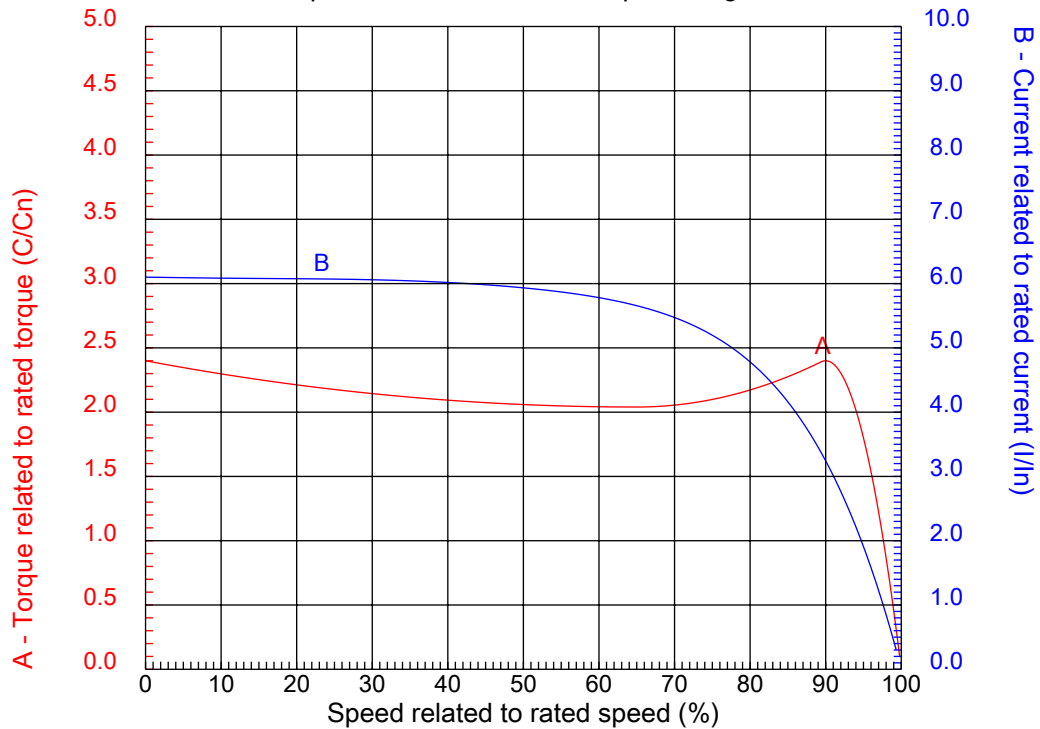

Customer :
Product line : W22 NEMA Premium - Ball Bearings

Frame	: 284/6TS	Locked rotor current (I _l /I _n)	: 6.1
Output	: 30 HP	Duty cycle	: S1
Frequency	: 60 Hz	Service factor	: 1.25
Full load speed	: 1765 rpm	Design	: B
Voltage	: 208-230/460 V	Locked rotor torque	: 240 %
Rated current	: 77.6-70.2/35.1 A	Breakdown torque	: 240 %
Insulation class	: F		

Notes:
Downloaded from <http://dealerselectric.com>
Generated for Model #03018ET3E286TS-W22

Performed by

Checked

1 2 3 4 5 6 7 8

A

B

C

D

E

F

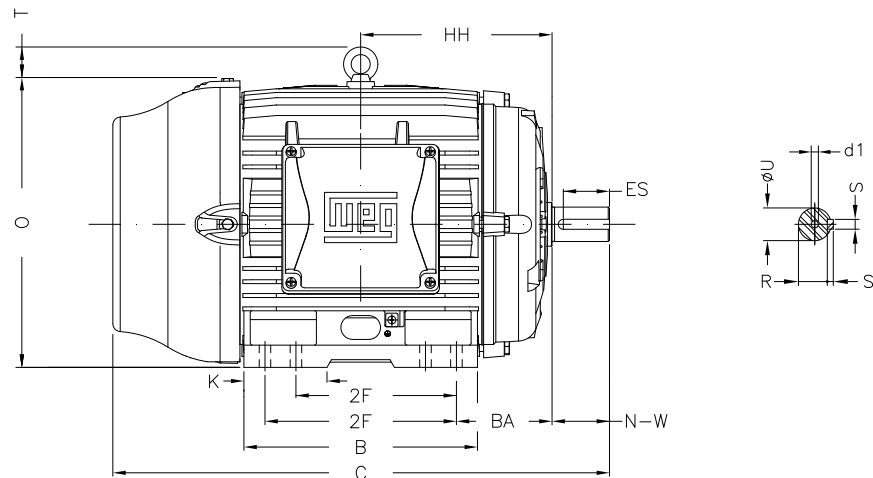
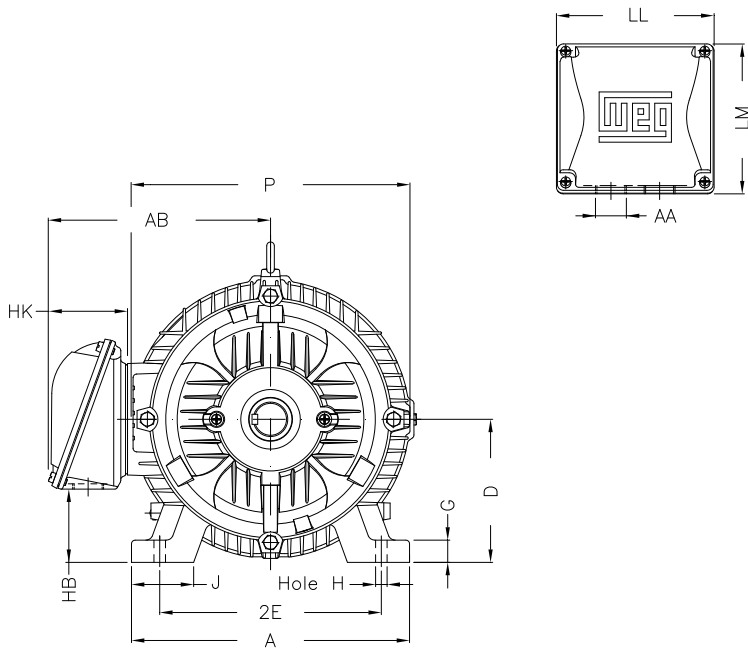

Notes: Downloaded from <http://dealerselectric.com>
Generated for Model #03018ET3E286TS-W22

Performed by:

Checked:

Customer:

W22 NEMA Premium - Ball Bearings

Three-phase induction motor
Frame 284/6TS - IP55

23-SEP-2016



2E 11.000	J 3.071	A 13.780	P 14.173	AB 11.073
2F 9.500/11.000	K 3.583	B 13.071	BA 4.750	FBA 7.876
U 1.625	N-W 3.250	ES 2.480	S 0.375	R 1.416
depth 0.375	D 7.000	G 1.023	HB 3.535	O 14.067
T 2.087	HF 7.000	HH 10.250	HK 3.976	H 0.531
C 26.557	LL 7.815	LM 7.480	AA NPT 1 1/2"	d1 A 4

1 2 3 4 5 6 7 8

A
B
C
D
E
F

LOW VOLTAGE

HIGH VOLTAGE



CONNECTIONS FOR STARTING ONLY:

LOW VOLTAGE

HIGH VOLTAGE



Notes: Downloaded from <http://dealerselectric.com>
Generated for Model #03018ET3E286TS-W22

Performed by:

Checked:

Customer:

W22 NEMA Premium - Ball Bearings

Three-phase induction motor
Frame 284/6TS - IP55

23-SEP-2016

