



Dealers Industrial Equipment

No.:

Date: 23-SEP-2016

Customer :

TECHNICAL PROPOSAL

Three-phase induction motor - Squirrel cage rotor

Product line : Three-Phase: W22 IEEE-841™ Petrochem Motors - NEMA Premium® Efficiency

Catalog Number : 03012ST3QIE326T-W22

List Price : \$5,359

Notes:

Downloaded from <http://dealerselectric.com>

Generated for Model #03012ST3QIE326T-W22

Performed by:

Checked:



Dealers Industrial Equipment

No.:

Date: 23-SEP-2016

DATA SHEET Three-phase induction motor - Squirrel cage rotor

Customer :
 Product line : Three-Phase: W22 IEEE-841™ Petrochem Motors - NEMA Premium® Efficiency

Frame : 324/6T
 Output : 30 HP
 Frequency : 60 Hz
 Poles : 6
 Full load speed : 1180 rpm
 Slip : 1.67 %
 Voltage : 460 V
 Rated current : 35.8 A
 Locked rotor current : 215 A
 Locked rotor current (I_L/I_n) : 6.0
 No-load current : 15.0 A
 Full load torque : 132 lb.ft
 Locked rotor torque : 220 %
 Breakdown torque : 250 %
 Design : B
 Insulation class : F
 Temperature rise : 80 K
 Locked rotor time : 21 s (hot)
 Service factor : 1.25
 Duty cycle : S1
 Ambient temperature : -20°C - +40°C
 Altitude : 1000 m
 Degree of Protection : IP55
 Approximate weight : 628 lb
 Moment of inertia : 13.196 sq.ft.lb
 Noise level : 62 dB(A)

	D.E.	N.D.E.
Bearings	6312 C3	6212 C3
Regreasing interval	20000 h	20000 h
Grease amount	21 g	13 g

Load	Power factor	Efficiency (%)
100%	0.83	93.0
75%	0.77	93.0
50%	0.65	91.7

Notes:
 Downloaded from <http://dealerselectric.com>
 Generated for Model #03012ST3QIE326T-W22

Performed by

Checked



Dealers Industrial Equipment

No.:

Date: 23-SEP-2016

PERFORMANCE CURVES RELATED TO RATED OUTPUT

Three-phase induction motor - Squirrel cage rotor

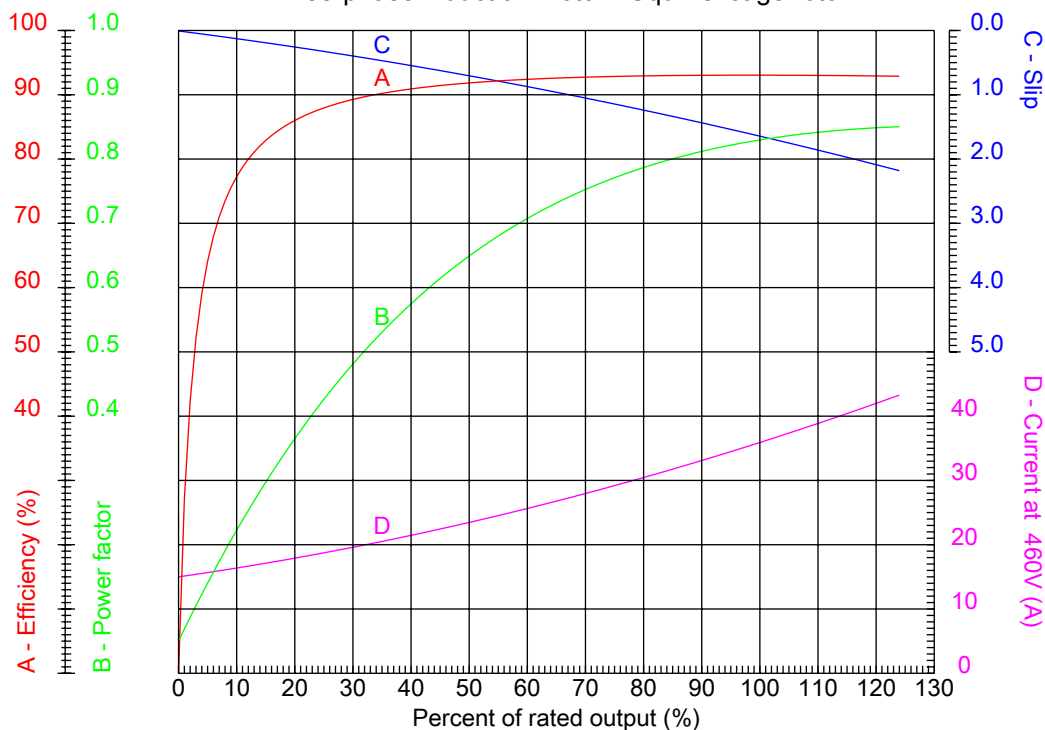

Customer :
Product line : Three-Phase: W22 IEEE-841™ Petrochem Motors - NEMA Premium® Efficiency

Frame : 324/6T	Locked rotor current (I _L /I _n) : 6.0
Output : 30 HP	Duty cycle : S1
Frequency : 60 Hz	Service factor : 1.25
Full load speed : 1180 rpm	Design : B
Voltage : 460 V	Locked rotor torque : 220 %
Rated current : 35.8 A	Breakdown torque : 250 %
Insulation class : F	

Notes:
Downloaded from <http://dealerselectric.com>
Generated for Model #03012ST3QIE326T-W22

Performed by

Checked



Dealers Industrial Equipment

No.:

Date: 23-SEP-2016

CHARACTERISTIC CURVES RELATED TO SPEED

Three-phase induction motor - Squirrel cage rotor

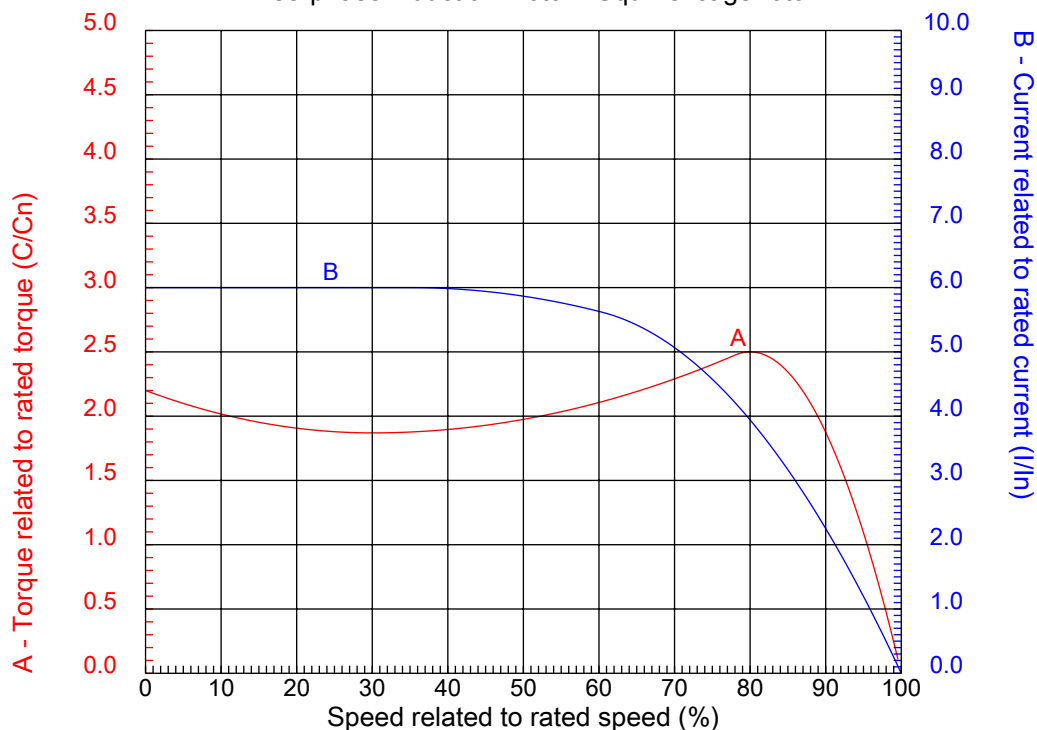

Customer :
Product line : Three-Phase: W22 IEEE-841™ Petrochem Motors - NEMA Premium® Efficiency

Frame	: 324/6T	Locked rotor current (I _l /I _n)	: 6.0
Output	: 30 HP	Duty cycle	: S1
Frequency	: 60 Hz	Service factor	: 1.25
Full load speed	: 1180 rpm	Design	: B
Voltage	: 460 V	Locked rotor torque	: 220 %
Rated current	: 35.8 A	Breakdown torque	: 250 %
Insulation class	: F		

Notes:
Downloaded from <http://dealerselectric.com>
Generated for Model #03012ST3QIE326T-W22

Performed by

Checked

1 2 3 4 5 6 7 8

A

B

C

D

E

F

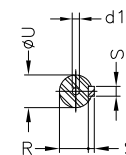
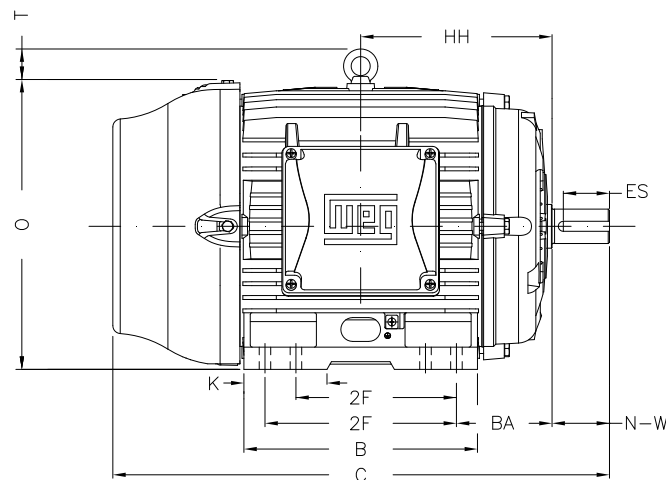
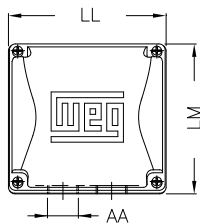
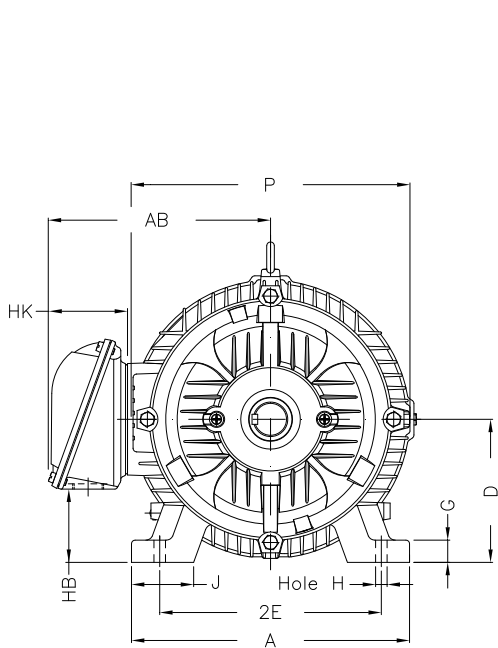

Notes: Downloaded from <http://dealerselectric.com>
Generated for Model #03012ST3QIE326T-W22

Performed by:

Checked:

Customer:

Three-Phase: W22 IEEE-841™ Petrochem Motors - NEMA Premium® Efficiency

Three-phase induction motor
Frame 324/6T - IP55

23-SEP-2016



2E 12.500	J 3.189	A 15.157	P 15.827	AB 12.575
2F 10.500/12.000	K 4.055	B 14.567	BA 5.250	U 2.125
N-W 5.250	ES 3.937	S 0.500	R 1.844	depth 0.500
D 8.000	G 1.300	HB 4.811	O 15.953	T 2.441
HF 8.708	HH 11.250	HK 4.705	H 0.657	C 31.116
LL 9.055	LM 8.661	AA NPT 2"	d1 A 4	d2 A 4

1 2 3 4 5 6 7 8

A

B

C

D

E

F



Notes: Downloaded from <http://dealerselectric.com>
Generated for Model #03012ST3QIE326T-W22

Performed by:

Checked:

Customer:

Three-Phase: W22 IEEE-841™ Petrochem Motors - NEMA Premium® Efficiency

Three-phase induction motor
Frame 324/6T - IP55

23-SEP-2016

