



Dealers Industrial Equipment

No.:

Date: 23-SEP-2016

Customer :

TECHNICAL PROPOSAL

Three-phase induction motor - Squirrel cage rotor

Product line : Fire Pump Motors - ODP Three Phase - Foot Mount and Flange Mount

Catalog Number : 02536OP3EFP256T

List Price : \$1,783

Notes:

Downloaded from <http://dealerselectric.com>

Generated for Model #02536OP3EFP256T

Performed by:

Checked:



# Dealers Industrial Equipment

No.:

Date: 23-SEP-2016

## DATA SHEET Three-phase induction motor - Squirrel cage rotor

Customer :  
 Product line : Fire Pump Motors - ODP Three Phase - Foot Mount and Flange Mount

Frame : 256T  
 Output : 25 HP  
 Frequency : 60 Hz  
 Poles : 2  
 Full load speed : 3530 rpm  
 Slip : 1.94 %  
 Voltage : 208-230/460 V  
 Rated current : 64.8-58.6/29.3 A  
 Locked rotor current : 352/176 A  
 Locked rotor current (I<sub>L</sub>/I<sub>n</sub>) : 6.0  
 No-load current : 18.8/9.40 A  
 Full load torque : 36.7 lb.ft  
 Locked rotor torque : 200 %  
 Breakdown torque : 250 %  
 Design : B  
 Insulation class : F  
 Temperature rise : 80 K  
 Locked rotor time : 10 s (hot)  
 Service factor : 1.15  
 Duty cycle : S1  
 Ambient temperature : -20°C - +40°C  
 Altitude : 1000 m  
 Degree of Protection : IP23  
 Approximate weight : 230 lb  
 Moment of inertia : 0.97744 sq.ft.lb  
 Noise level : 67 dB(A)

	D.E.	N.D.E.
Bearings	6309 Z-C3	6209 Z-C3
Regreasing interval	20000 h	20000 h
Grease amount	13 g	9 g

Load	Power factor	Efficiency (%)
100%	0.87	91.0
75%	0.84	91.0
50%	0.76	90.2

Notes:  
 Downloaded from <http://dealerselectric.com>  
 Generated for Model #02536OP3EFP256T

Performed by

Checked



# Dealers Industrial Equipment

No.:

Date: 23-SEP-2016

## PERFORMANCE CURVES RELATED TO RATED OUTPUT

Three-phase induction motor - Squirrel cage rotor

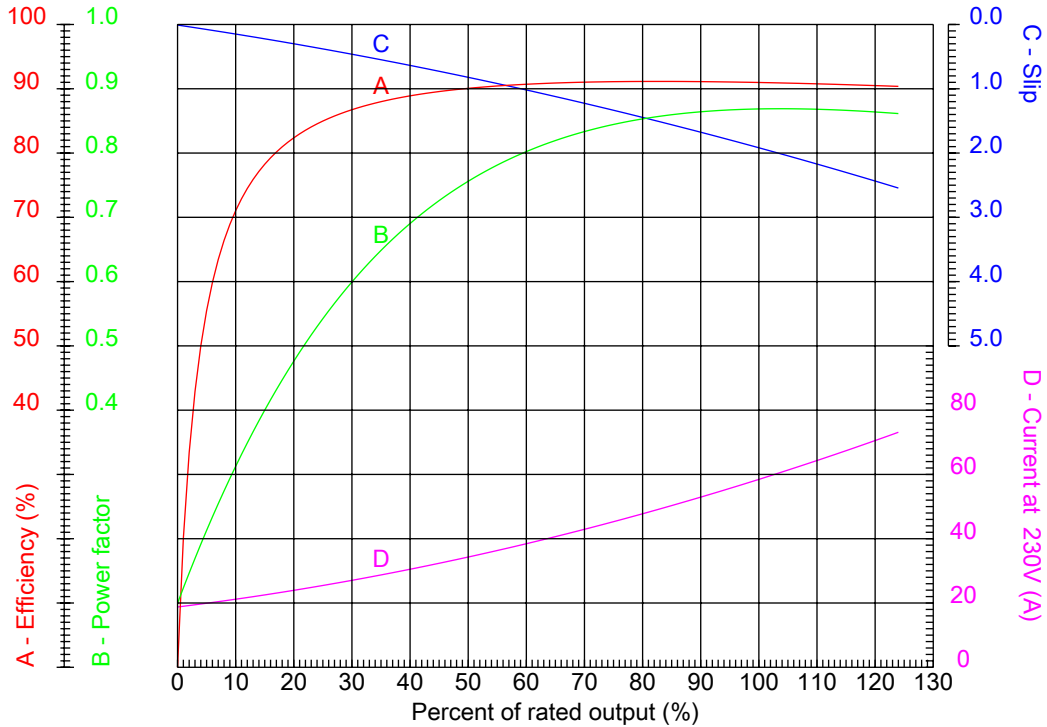

Customer :  
Product line : Fire Pump Motors - ODP Three Phase - Foot Mount and Flange Mount

Frame	: 256T	Locked rotor current (I <sub>l</sub> /I <sub>n</sub> )	: 6.0
Output	: 25 HP	Duty cycle	: S1
Frequency	: 60 Hz	Service factor	: 1.15
Full load speed	: 3530 rpm	Design	: B
Voltage	: 208-230/460 V	Locked rotor torque	: 200 %
Rated current	: 64.8-58.6/29.3 A	Breakdown torque	: 250 %
Insulation class	: F		

Notes:  
Downloaded from <http://dealerselectric.com>  
Generated for Model #02536OP3EFP256T

Performed by

Checked



## CHARACTERISTIC CURVES RELATED TO SPEED

Three-phase induction motor - Squirrel cage rotor

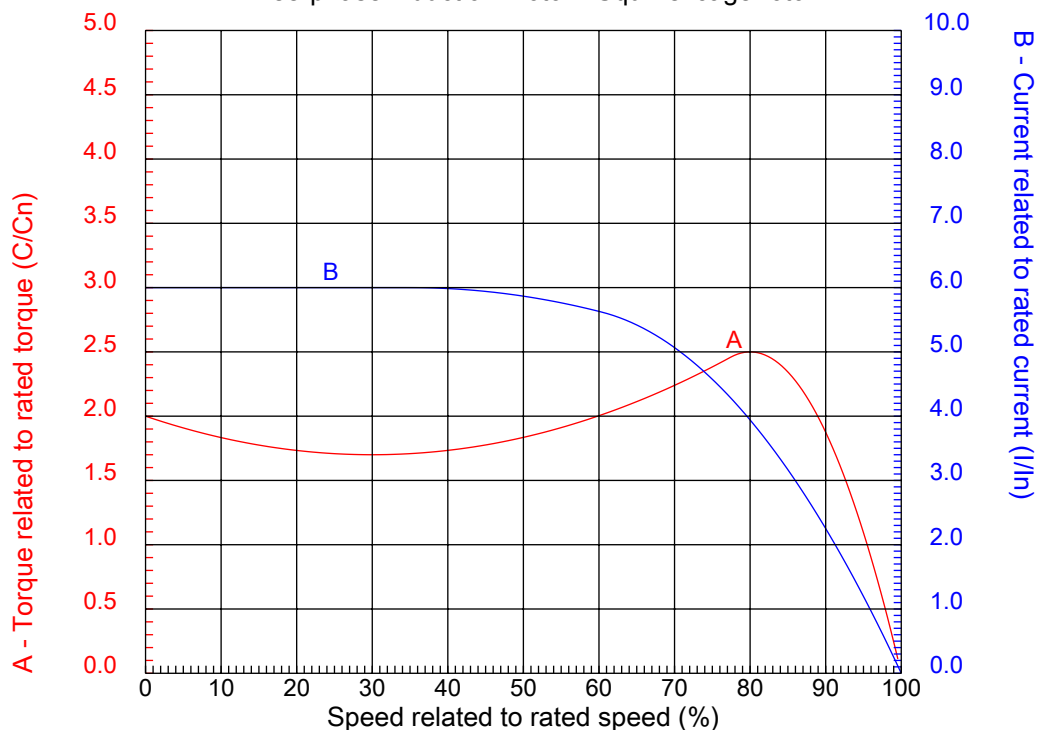

Customer :  
Product line : Fire Pump Motors - ODP Three Phase - Foot Mount and Flange Mount

Frame	: 256T	Locked rotor current (I <sub>l</sub> /I <sub>n</sub> )	: 6.0
Output	: 25 HP	Duty cycle	: S1
Frequency	: 60 Hz	Service factor	: 1.15
Full load speed	: 3530 rpm	Design	: B
Voltage	: 208-230/460 V	Locked rotor torque	: 200 %
Rated current	: 64.8-58.6/29.3 A	Breakdown torque	: 250 %
Insulation class	: F		

Notes:  
Downloaded from <http://dealerselectric.com>  
Generated for Model #02536OP3EFP256T

Performed by

Checked

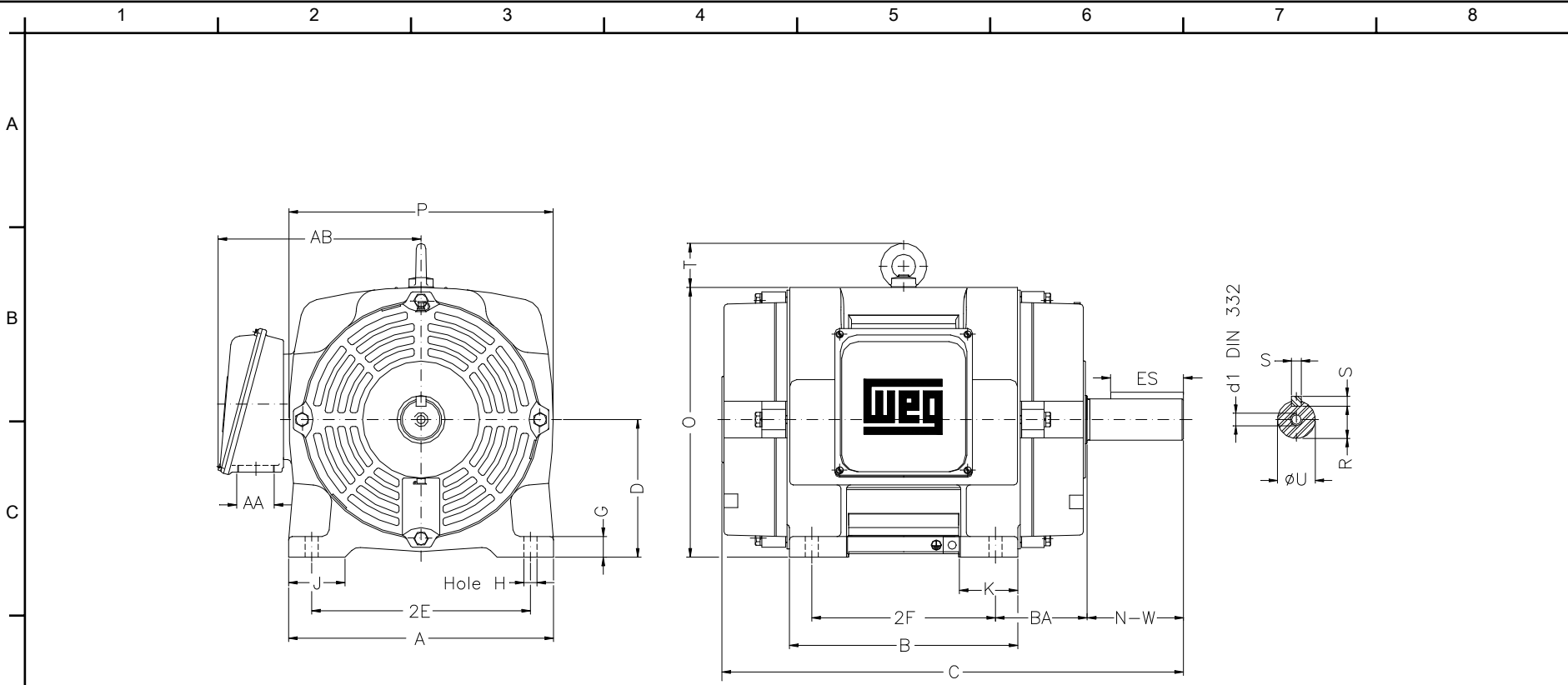

Notes: Downloaded from <http://dealerselectric.com>  
 Generated for Model #02536OP3EFP256T

Performed by:

Checked:

Customer:

Fire Pump Motors - ODP Three Phase - Foot Mount and Flange Mount

2E 10.000	A 12.130	2F 10.000	B 11.732	BA 4.250
J 2.520	K 2.560	P 11.812	ES 2.756	depth 0.375
S 0.375	D 6.250	N-W 4.000	G 0.787	U 1.625
O 12.204	T 2.165	R 1.416	H 0.531	AB 10.079
C 22.401	AA NPT 1 1/2"	d1 A 4		

Three-phase induction motor  
 Frame 256T - IP23

23-SEP-2016



1 2 3 4 5 6 7 8

A  
B  
C  
D  
E  
F

LOW VOLTAGE

HIGH VOLTAGE

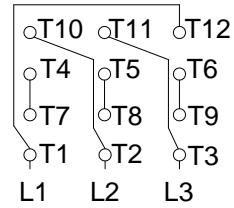
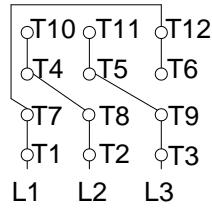

CONNECTIONS FOR STARTING ONLY:

LOW VOLTAGE

HIGH VOLTAGE

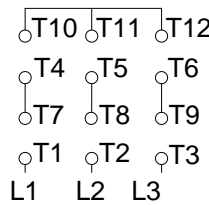
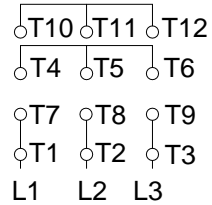

Notes: Downloaded from <http://dealerselectric.com>  
Generated for Model #02536OP3EFP256T

Performed by:

Checked:

Customer:

Fire Pump Motors - ODP Three Phase - Foot Mount and Flange Mount

Three-phase induction motor  
Frame 256T - IP23

23-SEP-2016

