



Dealers Industrial Equipment

No.:

Date: 23-SEP-2016

Customer :

TECHNICAL PROPOSAL

Three-phase induction motor - Squirrel cage rotor

Product line : W22 Cooling Tower Motors: NEMA Premium - TEFC

Catalog Number : 02518ET3ECT284T-W22

List Price : \$3,236

Notes:

Downloaded from <http://dealerselectric.com>

Generated for Model #02518ET3ECT284T-W22

Performed by:

Checked:



Dealers Industrial Equipment

No.:

Date: 23-SEP-2016

DATA SHEET Three-phase induction motor - Squirrel cage rotor

Customer :
Product line : W22 Cooling Tower Motors: NEMA Premium - TEFC

Frame : 284T
Output : 25 HP
Frequency : 60 Hz
Poles : 4
Full load speed : 1765 rpm
Slip : 1.94 %
Voltage : 208-230/460 V
Rated current : 65.2-59.0/29.5 A
Locked rotor current : 366/183 A
Locked rotor current (I_L/I_n) : 6.2
No-load current : 21.0/10.5 A
Full load torque : 73.4 lb.ft
Locked rotor torque : 240 %
Breakdown torque : 270 %
Design : B
Insulation class : F
Temperature rise : 80 K
Locked rotor time : 24 s (hot)
Service factor : 1.25
Duty cycle : S1
Ambient temperature : -20°C - +40°C
Altitude : 1000 m
Degree of Protection : IP55
Approximate weight : 388 lb
Moment of inertia : 5.1084 sq.ft.lb
Noise level : 64 dB(A)

	D.E.	N.D.E.
Bearings	6311 2RS-C3	6211 2RS-C3
Regreasing interval	---	---
Grease amount	---	---

Load	Power factor	Efficiency (%)
100%	0.84	93.6
75%	0.80	93.0
50%	0.70	92.4

Notes:
Downloaded from <http://dealerselectric.com>
Generated for Model #02518ET3ECT284T-W22

Performed by

Checked



Dealers Industrial Equipment

No.:

Date: 23-SEP-2016

PERFORMANCE CURVES RELATED TO RATED OUTPUT

Three-phase induction motor - Squirrel cage rotor

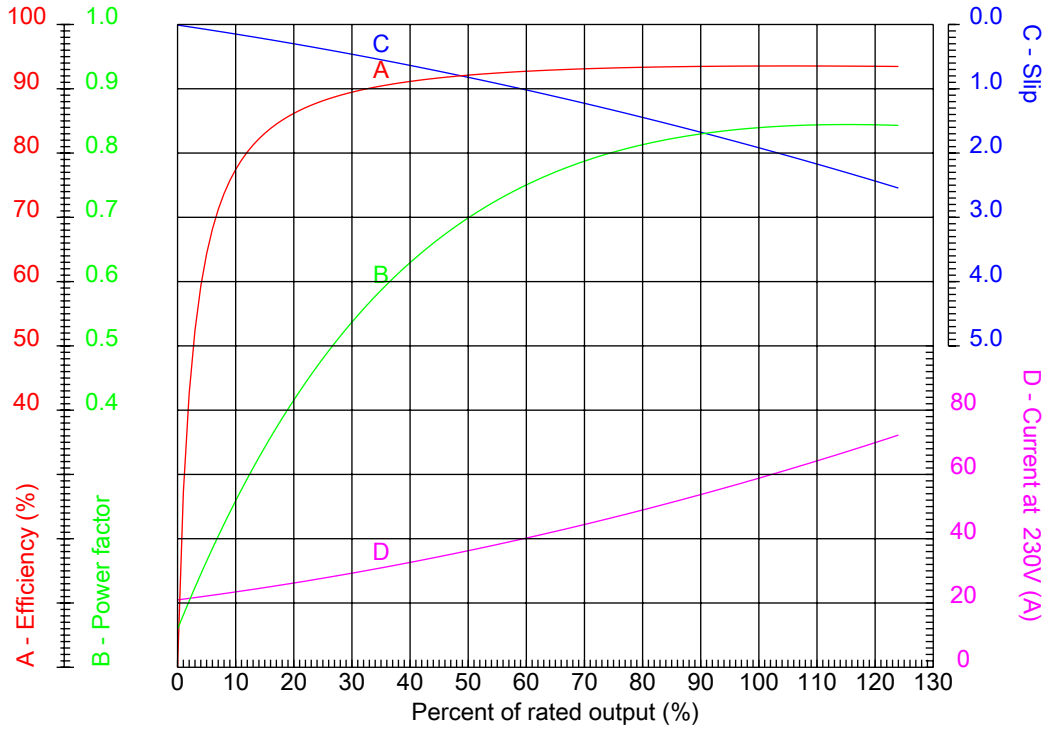

Customer :
 Product line : W22 Cooling Tower Motors: NEMA Premium - TEFC

Frame	: 284T	Locked rotor current (I _L /I _n)	: 6.2
Output	: 25 HP	Duty cycle	: S1
Frequency	: 60 Hz	Service factor	: 1.25
Full load speed	: 1765 rpm	Design	: B
Voltage	: 208-230/460 V	Locked rotor torque	: 240 %
Rated current	: 65.2-59.0/29.5 A	Breakdown torque	: 270 %
Insulation class	: F		

Notes:
 Downloaded from <http://dealerselectric.com>
 Generated for Model #02518ET3ECT284T-W22

Performed by

Checked



Dealers Industrial Equipment

No.:

Date: 23-SEP-2016

CHARACTERISTIC CURVES RELATED TO SPEED

Three-phase induction motor - Squirrel cage rotor

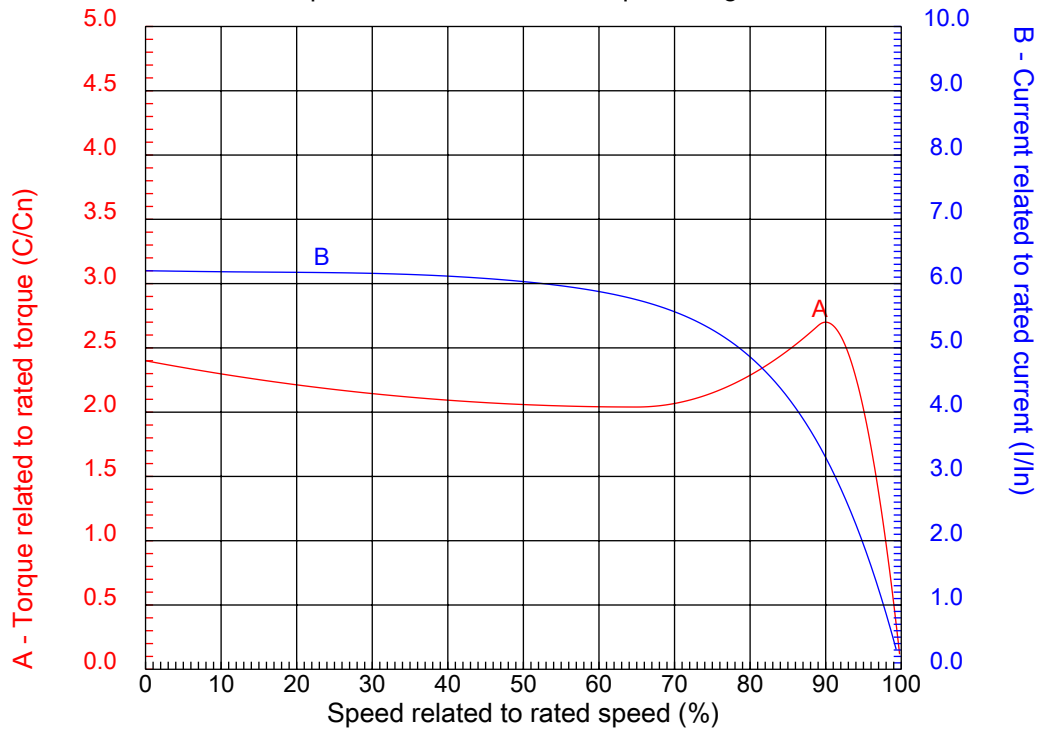

Customer :
Product line : W22 Cooling Tower Motors: NEMA Premium - TEFC

Frame	: 284T	Locked rotor current (I _l /I _n)	: 6.2
Output	: 25 HP	Duty cycle	: S1
Frequency	: 60 Hz	Service factor	: 1.25
Full load speed	: 1765 rpm	Design	: B
Voltage	: 208-230/460 V	Locked rotor torque	: 240 %
Rated current	: 65.2-59.0/29.5 A	Breakdown torque	: 270 %
Insulation class	: F		

Notes:
Downloaded from <http://dealerselectric.com>
Generated for Model #02518ET3ECT284T-W22

Performed by

Checked

1 2 3 4 5 6 7 8

A
B
C
D
E
F

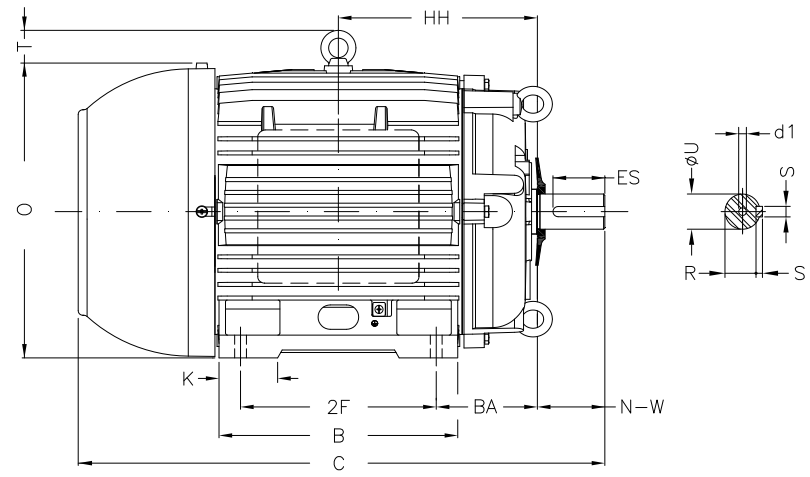
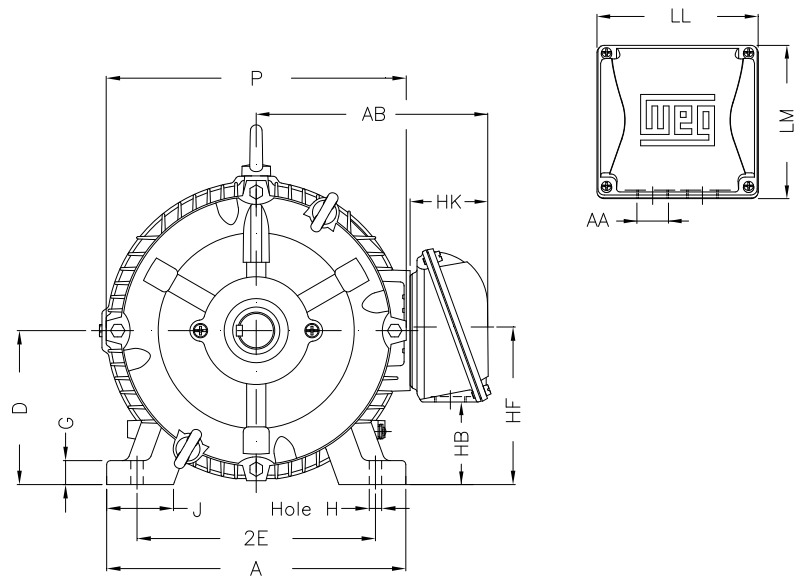

Notes: Downloaded from <http://dealerselectric.com>
Generated for Model #02518ET3ECT284T-W22

Performed by:

Checked:

Customer:

W22 Cooling Tower Motors: NEMA Premium - TEFC

Three-phase induction motor
Frame 284T - IP55

23-SEP-2016



2E 11.000	J 3.071	A 13.780	P 13.780	AB 11.073
2F 9.500	K 3.583	B 11.575	BA 4.750	U 1.875
N-W 4.622	ES 3.149	S 0.500	R 1.594	depth 0.500
D 7.000	G 1.023	HB 3.535	O 14.067	T 2.087
HF 7.000	HH 9.500	HK 3.976	H 0.531	C 26.433
LL 7.815	LM 7.480	AA NPT 1 1/2"	d1 A 4	d2 A 4

1 2 3 4 5 6 7 8

A
B
C
D
E
F

LOW VOLTAGE

HIGH VOLTAGE



CONNECTIONS FOR STARTING ONLY:

LOW VOLTAGE

HIGH VOLTAGE



Notes: Downloaded from <http://dealerselectric.com>
Generated for Model #02518ET3ECT284T-W22

Performed by:

Checked:

Customer:

W22 Cooling Tower Motors: NEMA Premium - TEFC

Three-phase induction motor
Frame 284T - IP55

23-SEP-2016

