



Dealers Industrial Equipment

No.:

Date: 23-SEP-2016

Customer :

TECHNICAL PROPOSAL

Three-phase induction motor - Squirrel cage rotor

Product line : Brake Motors : Three-Phase - High Efficiency
Catalog Number : 02518EP3EBM284T
List Price : \$(discontinued)

Notes:
Downloaded from <http://dealerselectric.com>
Generated for Model #02518EP3EBM284T

Performed by:

Checked:



Dealers Industrial Equipment

No.:

Date: 23-SEP-2016

DATA SHEET Three-phase induction motor - Squirrel cage rotor

Customer :
Product line : Brake Motors : Three-Phase - High Efficiency

Frame : 284T
Output : 25 HP
Frequency : 60 Hz
Poles : 4
Full load speed : 1765 rpm
Slip : 1.94 %
Voltage : 230/460 V
Rated current : 59.2/29.6 A
Locked rotor current : 361/181 A
Locked rotor current (I_L/I_n) : 6.1
No-load current : 18.8/9.40 A
Full load torque : 73.4 lb.ft
Locked rotor torque : 230 %
Breakdown torque : 250 %
Design : B
Insulation class : F
Temperature rise : 80 K
Locked rotor time : 30 s (hot)
Service factor : 1.25
Duty cycle : S1
Ambient temperature : -20°C - +40°C
Altitude : 1000 m
Degree of Protection : IP55
Approximate weight : 397 lb
Moment of inertia : 4.7491 sq.ft.lb
Noise level : 68 dB(A)

	D.E.	N.D.E.
Bearings	6311 C3	6214 Z-C3
Regreasing interval	20000 h	20000 h
Grease amount	18 g	15 g

Load	Power factor	Efficiency (%)
100%	0.85	92.4
75%	0.82	92.4
50%	0.74	92.4

Notes:
Downloaded from <http://dealerselectric.com>
Generated for Model #02518EP3EBM284T

Performed by

Checked



Dealers Industrial Equipment

No.:

Date: 23-SEP-2016

PERFORMANCE CURVES RELATED TO RATED OUTPUT

Three-phase induction motor - Squirrel cage rotor

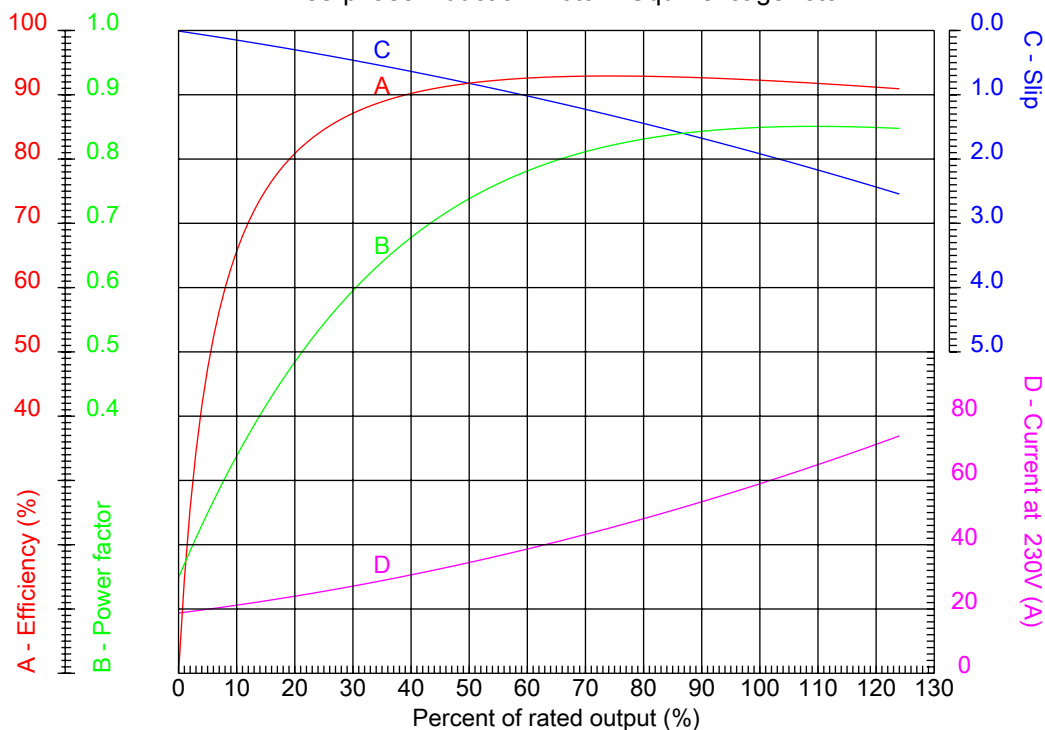

Customer :
Product line : Brake Motors : Three-Phase - High Efficiency

Frame	: 284T	Locked rotor current (I _l /I _n)	: 6.1
Output	: 25 HP	Duty cycle	: S1
Frequency	: 60 Hz	Service factor	: 1.25
Full load speed	: 1765 rpm	Design	: B
Voltage	: 230/460 V	Locked rotor torque	: 230 %
Rated current	: 59.2/29.6 A	Breakdown torque	: 250 %
Insulation class	: F		

Notes:
Downloaded from <http://dealerselectric.com>
Generated for Model #02518EP3EBM284T

Performed by

Checked



Dealers Industrial Equipment

No.:

Date: 23-SEP-2016

CHARACTERISTIC CURVES RELATED TO SPEED

Three-phase induction motor - Squirrel cage rotor

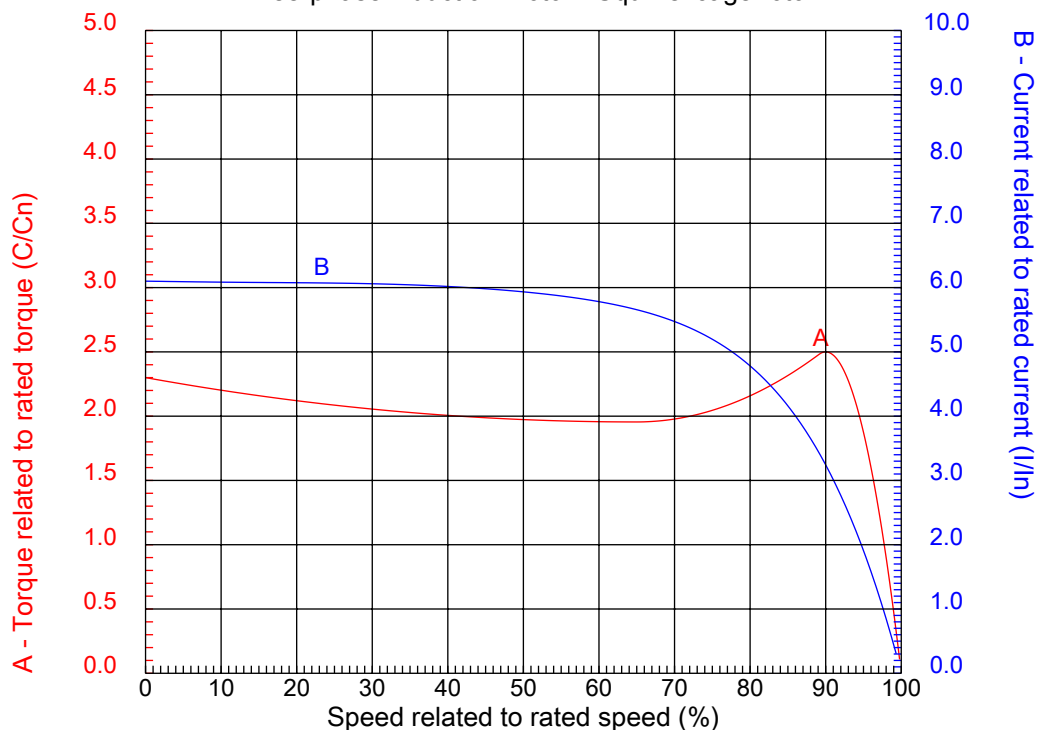

Customer :
Product line : Brake Motors : Three-Phase - High Efficiency

Frame	: 284T	Locked rotor current (I _l /I _n)	: 6.1
Output	: 25 HP	Duty cycle	: S1
Frequency	: 60 Hz	Service factor	: 1.25
Full load speed	: 1765 rpm	Design	: B
Voltage	: 230/460 V	Locked rotor torque	: 230 %
Rated current	: 59.2/29.6 A	Breakdown torque	: 250 %
Insulation class	: F		

Notes:
Downloaded from <http://dealerselectric.com>
Generated for Model #02518EP3EBM284T

Performed by

Checked

1 2 3 4 5 6 7 8

A

B

C

D

E

F

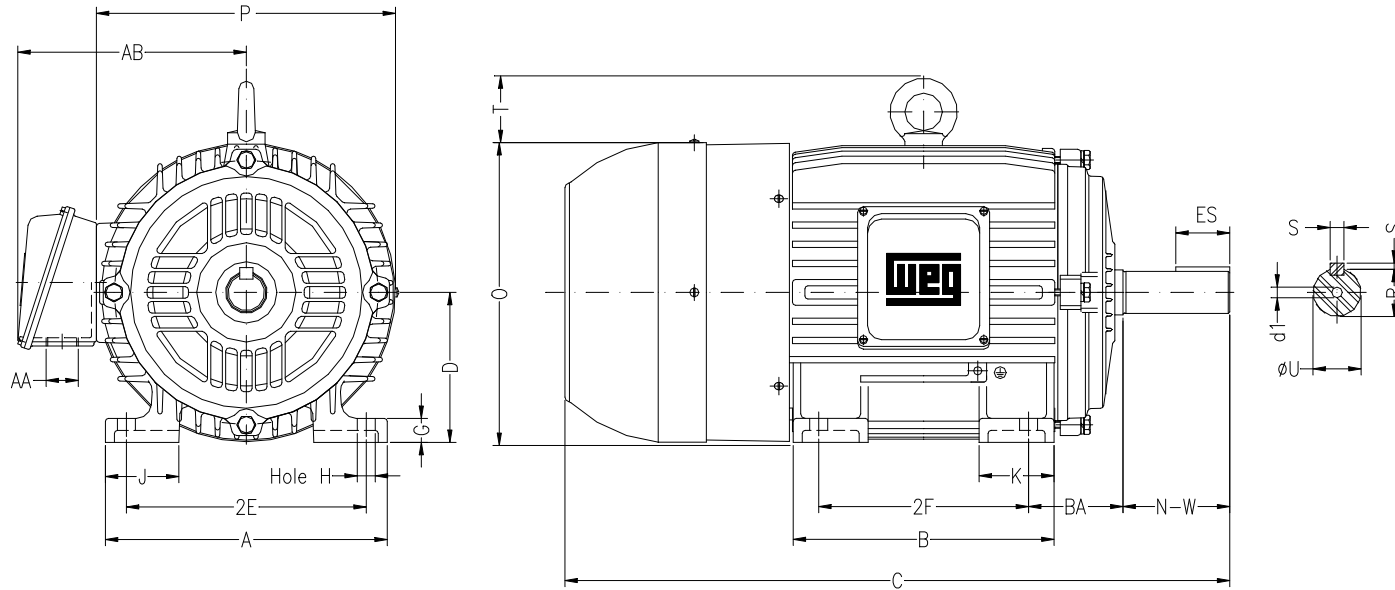

Notes: Downloaded from <http://dealerselectric.com>
Generated for Model #02518EP3EBM284T

Performed by:

Checked:

Customer:

Brake Motors : Three-Phase - High Efficiency

2E 11.000	A 13.780	2F 9.500	B 11.575	BA 4.750
J 3.150	K 2.953	P 14.094	ES 3.149	depth 0.500
S 0.500	N-W 4.622	U 1.875	R 1.594	AB 10.866
D 7.000	G 1.016	O 14.067	T 2.087	H 0.531
C 31.236	AA NPT 1 1/2"	d1 A 4	d2 A 4	

Three-phase induction motor
Frame 284T - IP55

23-SEP-2016



1 2 3 4 5 6 7 8

A
B
C
D
E
F

LOW VOLTAGE

HIGH VOLTAGE

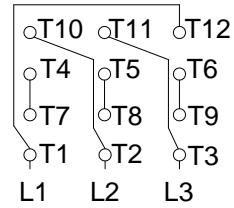
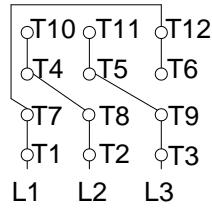

CONNECTIONS FOR STARTING ONLY:

LOW VOLTAGE

HIGH VOLTAGE

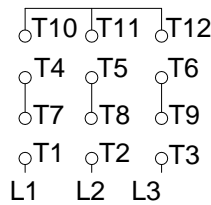
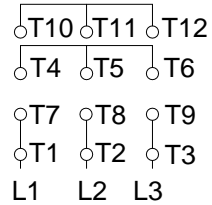

Notes: Downloaded from <http://dealerselectric.com>
Generated for Model #02518EP3EBM284T

Performed by:

Checked:

Customer:

Brake Motors : Three-Phase - High Efficiency

Three-phase induction motor
Frame 284T - IP55

23-SEP-2016

