



Dealers Industrial Equipment

No.:

Date: 23-SEP-2016

Customer :

TECHNICAL PROPOSAL

Three-phase induction motor - Squirrel cage rotor

Product line : W22 Super Premium

Catalog Number : 02518EG3E284T-W22

List Price : \$3,017

Notes:

Downloaded from <http://dealerselectric.com>

Generated for Model #02518EG3E284T-W22

Performed by:

Checked:



Dealers Industrial Equipment

No.:

Date: 23-SEP-2016

DATA SHEET Three-phase induction motor - Squirrel cage rotor

Customer :
Product line : W22 Super Premium

Frame : 284/6T
 Output : 25 HP
 Frequency : 60 Hz
 Poles : 4
 Full load speed : 1775 rpm
 Slip : 1.39 %
 Voltage : 208-230/460 V
 Rated current : 67.0-60.6/30.3 A
 Locked rotor current : 503/251 A
 Locked rotor current (I_L/I_n) : 8.3
 No-load current : 30.0/15.0 A
 Full load torque : 73.0 lb.ft
 Locked rotor torque : 300 %
 Breakdown torque : 340 %
 Design : A
 Insulation class : F
 Temperature rise : 80 K
 Locked rotor time : 26 s (hot)
 Service factor : 1.25
 Duty cycle : S1
 Ambient temperature : -20°C - +40°C
 Altitude : 1000 m
 Degree of Protection : IP55
 Approximate weight : 406 lb
 Moment of inertia : 4.9449 sq.ft.lb
 Noise level : 64 dB(A)

	D.E.	N.D.E.
Bearings	6311 C3	6211 C3
Regreasing interval	20000 h	20000 h
Grease amount	18 g	11 g

Load	Power factor	Efficiency (%)
100%	0.81	94.5
75%	0.74	94.1
50%	0.62	93.0

Notes:
 Downloaded from <http://dealerselectric.com>
 Generated for Model #02518EG3E284T-W22

Performed by

Checked



Dealers Industrial Equipment

No.:

Date: 23-SEP-2016

PERFORMANCE CURVES RELATED TO RATED OUTPUT

Three-phase induction motor - Squirrel cage rotor

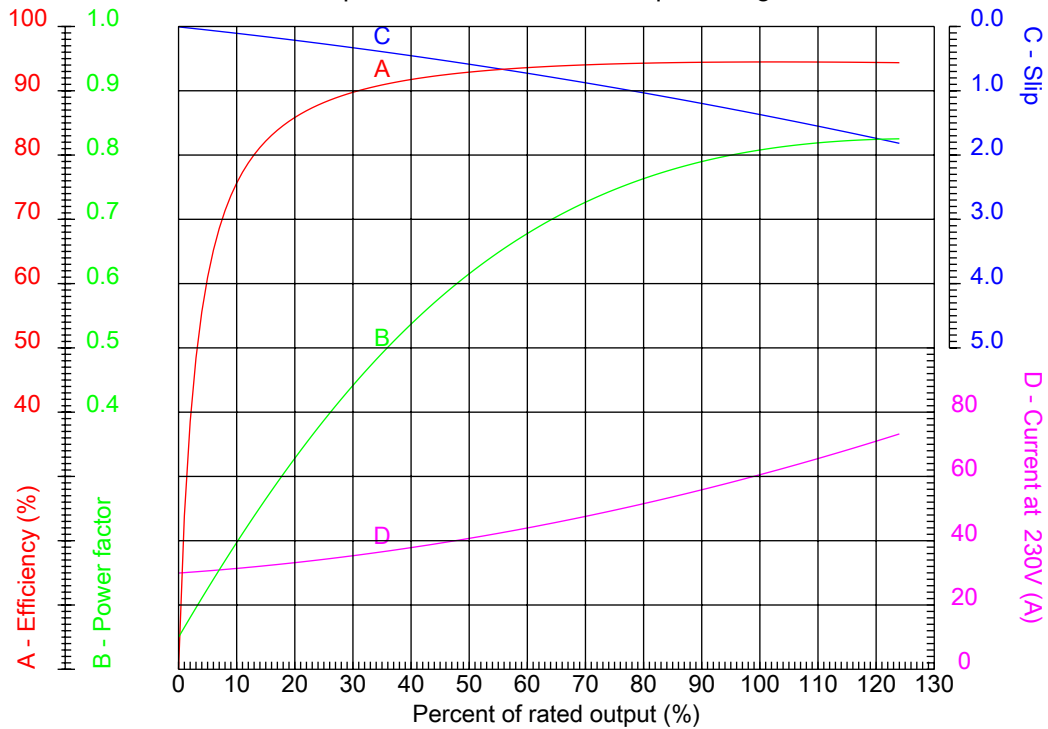

Customer :
Product line : W22 Super Premium

Frame : 284/6T	Locked rotor current (I _l /I _n) : 8.3
Output : 25 HP	Duty cycle : S1
Frequency : 60 Hz	Service factor : 1.25
Full load speed : 1775 rpm	Design : A
Voltage : 208-230/460 V	Locked rotor torque : 300 %
Rated current : 67.0-60.6/30.3 A	Breakdown torque : 340 %
Insulation class : F	

Notes:
Downloaded from <http://dealerselectric.com>
Generated for Model #02518EG3E284T-W22

Performed by

Checked



Dealers Industrial Equipment

No.:

Date: 23-SEP-2016

CHARACTERISTIC CURVES RELATED TO SPEED

Three-phase induction motor - Squirrel cage rotor

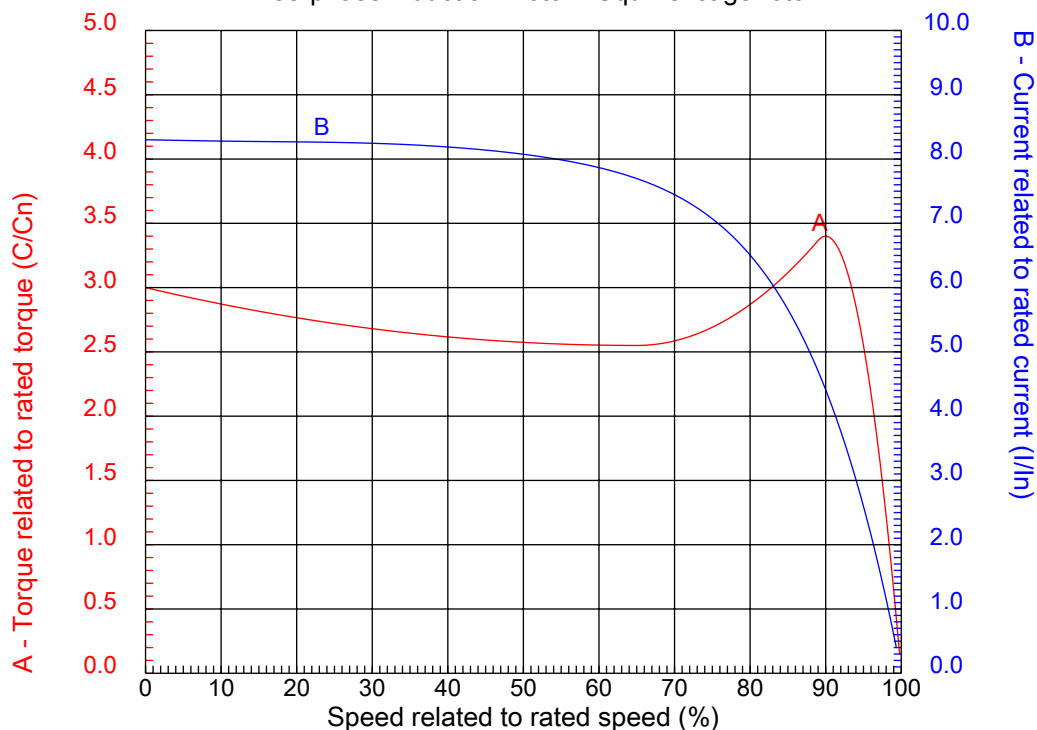

Customer :
Product line : W22 Super Premium

Frame	: 284/6T	Locked rotor current (I _l /I _n)	: 8.3
Output	: 25 HP	Duty cycle	: S1
Frequency	: 60 Hz	Service factor	: 1.25
Full load speed	: 1775 rpm	Design	: A
Voltage	: 208-230/460 V	Locked rotor torque	: 300 %
Rated current	: 67.0-60.6/30.3 A	Breakdown torque	: 340 %
Insulation class	: F		

Notes:
Downloaded from <http://dealerselectric.com>
Generated for Model #02518EG3E284T-W22

Performed by

Checked

1 2 3 4 5 6 7 8

A

B

C

D

E

F

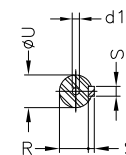
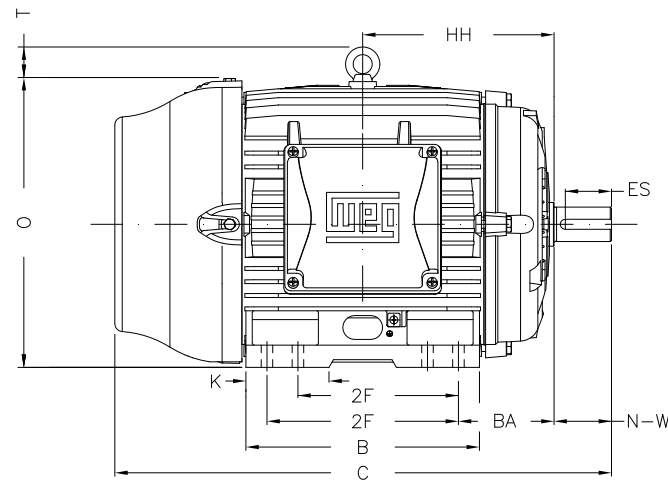
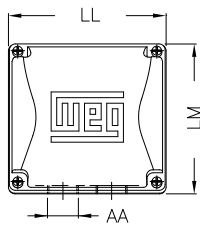
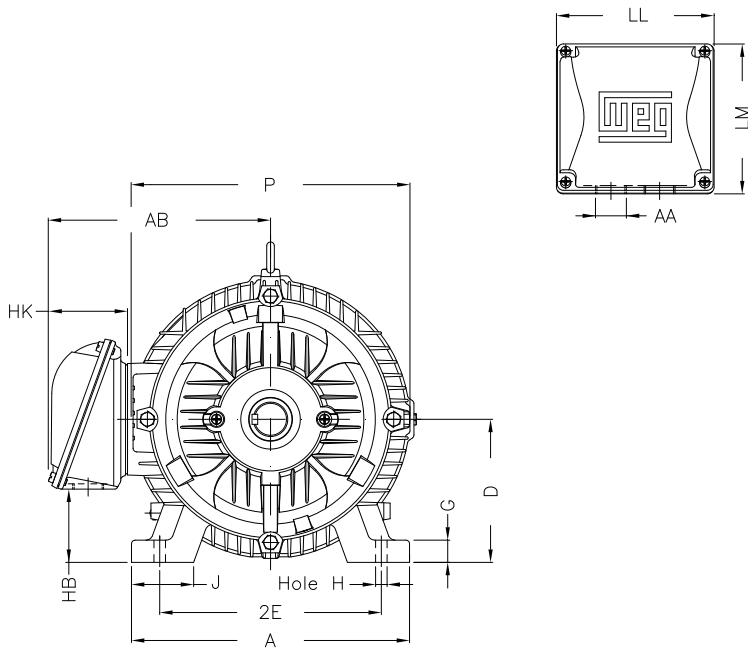

Notes: Downloaded from <http://dealerselectric.com>
Generated for Model #02518EG3E284T-W22

Performed by:

Checked:

Customer:

W22 Super Premium

Three-phase induction motor
Frame 284/6T - IP55

23-SEP-2016



2E 11.000	J 3.071	A 13.780	P 14.173	AB 11.073
2F 9.500/11.000	K 3.583	B 13.071	BA 4.750	FBA 7.876
U 1.875	N-W 4.622	ES 3.149	S 0.500	R 1.594
depth 0.500	D 7.000	G 1.023	HB 3.535	O 14.067
T 2.087	HF 7.000	HH 10.250	HK 3.976	H 0.531
C 27.929	LL 7.815	LM 7.480	AA NPT 1 1/2"	d1 A 4

1 2 3 4 5 6 7 8

A
B
C
D
E
F

LOW VOLTAGE

HIGH VOLTAGE



CONNECTIONS FOR STARTING ONLY:

LOW VOLTAGE

HIGH VOLTAGE



Notes: Downloaded from <http://dealerselectric.com>
Generated for Model #02518EG3E284T-W22

Performed by:

Checked:

Customer:

W22 Super Premium

Three-phase induction motor
Frame 284/6T - IP55

23-SEP-2016

