



Dealers Industrial Equipment

No.:

Date: 23-SEP-2016

Customer :

TECHNICAL PROPOSAL

Three-phase induction motor - Squirrel cage rotor

Product line : W22 Cooling Tower Motors: NEMA Premium - TEFC

Catalog Number : 02512ET3ECT324T-W22

List Price : \$5,543

Notes:

Downloaded from <http://dealerselectric.com>

Generated for Model #02512ET3ECT324T-W22

Performed by:

Checked:



Dealers Industrial Equipment

No.:

Date: 23-SEP-2016

DATA SHEET Three-phase induction motor - Squirrel cage rotor

Customer :
Product line : W22 Cooling Tower Motors: NEMA Premium - TEFC

Frame : 324T
Output : 25 HP
Frequency : 60 Hz
Poles : 6
Full load speed : 1180 rpm
Slip : 1.67 %
Voltage : 208-230/460 V
Rated current : 67.2-60.8/30.4 A
Locked rotor current : 377/188 A
Locked rotor current (I_L/I_n) : 6.2
No-load current : 28.0/14.0 A
Full load torque : 110 lb.ft
Locked rotor torque : 210 %
Breakdown torque : 260 %
Design : B
Insulation class : F
Temperature rise : 80 K
Locked rotor time : 26 s (hot)
Service factor : 1.25
Duty cycle : S1
Ambient temperature : -20°C - +40°C
Altitude : 1000 m
Degree of Protection : IP55
Approximate weight : 560 lb
Moment of inertia : 11.493 sq.ft.lb
Noise level : 62 dB(A)

	D.E.	N.D.E.
Bearings	6312 2RS-C3	6212 2RS-C3
Regreasing interval	---	---
Grease amount	---	---

Load	Power factor	Efficiency (%)
100%	0.82	93.0
75%	0.77	93.0
50%	0.65	91.7

Notes:
Downloaded from <http://dealerselectric.com>
Generated for Model #02512ET3ECT324T-W22

Performed by

Checked



Dealers Industrial Equipment

No.:

Date: 23-SEP-2016

PERFORMANCE CURVES RELATED TO RATED OUTPUT

Three-phase induction motor - Squirrel cage rotor

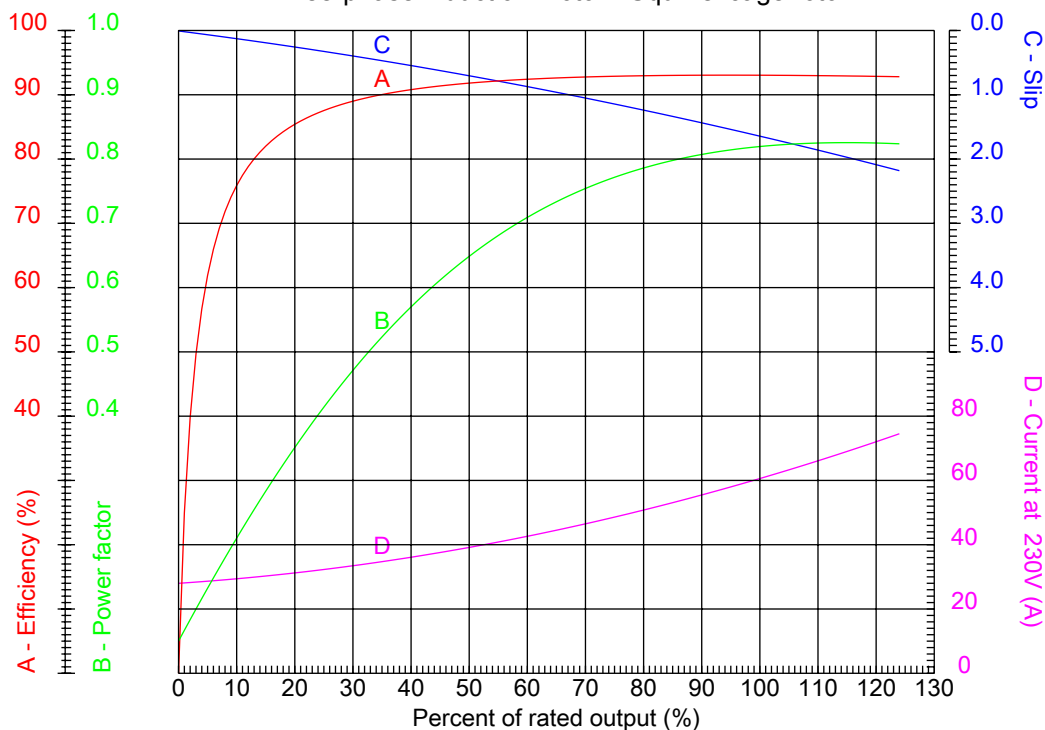

Customer :
Product line : W22 Cooling Tower Motors: NEMA Premium - TEFC

Frame	: 324T	Locked rotor current (I _l /I _n)	: 6.2
Output	: 25 HP	Duty cycle	: S1
Frequency	: 60 Hz	Service factor	: 1.25
Full load speed	: 1180 rpm	Design	: B
Voltage	: 208-230/460 V	Locked rotor torque	: 210 %
Rated current	: 67.2-60.8/30.4 A	Breakdown torque	: 260 %
Insulation class	: F		

Notes:
Downloaded from <http://dealerselectric.com>
Generated for Model #02512ET3ECT324T-W22

Performed by

Checked



Dealers Industrial Equipment

No.:

Date: 23-SEP-2016

CHARACTERISTIC CURVES RELATED TO SPEED

Three-phase induction motor - Squirrel cage rotor

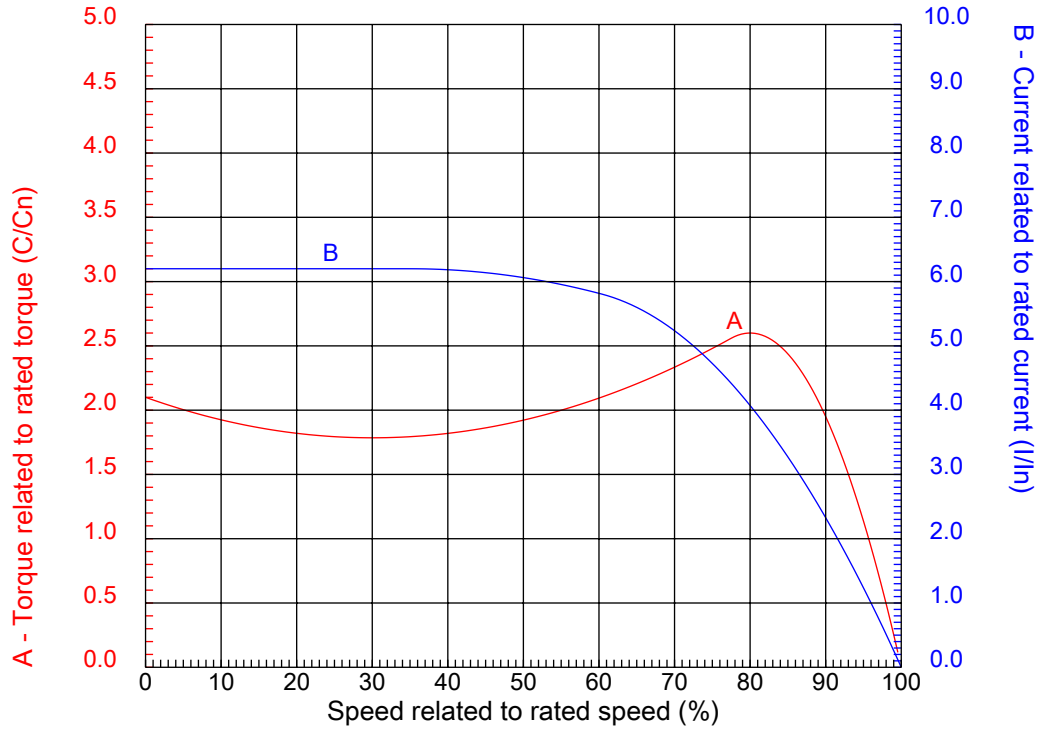

Customer :
Product line : W22 Cooling Tower Motors: NEMA Premium - TEFC

Frame	: 324T	Locked rotor current (I _l /I _n)	: 6.2
Output	: 25 HP	Duty cycle	: S1
Frequency	: 60 Hz	Service factor	: 1.25
Full load speed	: 1180 rpm	Design	: B
Voltage	: 208-230/460 V	Locked rotor torque	: 210 %
Rated current	: 67.2-60.8/30.4 A	Breakdown torque	: 260 %
Insulation class	: F		

Notes:
Downloaded from <http://dealerselectric.com>
Generated for Model #02512ET3ECT324T-W22

Performed by

Checked

1 2 3 4 5 6 7 8

A

B

C

D

E

F

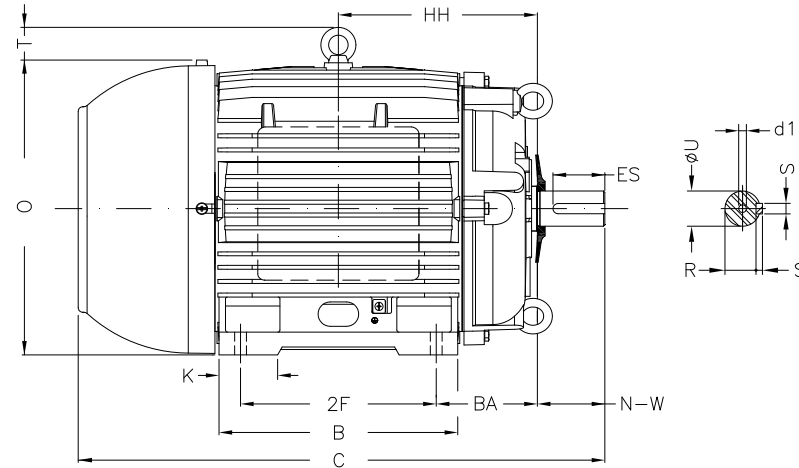
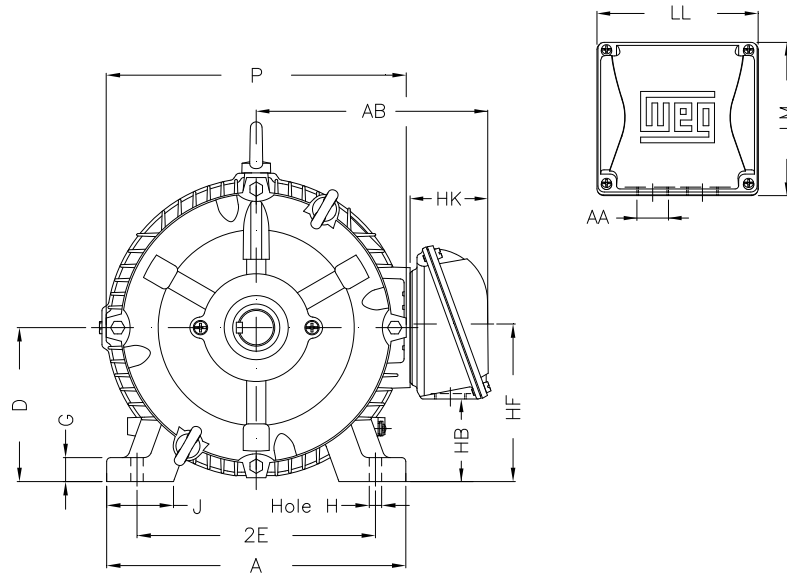

Notes: Downloaded from <http://dealerselectric.com>
Generated for Model #02512ET3ECT324T-W22

Performed by:

Checked:

Customer:

W22 Cooling Tower Motors: NEMA Premium - TEFC

Three-phase induction motor
Frame 324T - IP55

23-SEP-2016



2E 12.500	J 3.189	A 15.157	P 14.961	AB 12.575
2F 10.500	K 4.055	B 13.071	BA 5.250	U 2.125
N-W 5.250	ES 3.937	S 0.500	R 1.844	depth 0.500
D 8.000	G 1.300	HB 4.811	O 15.953	T 2.441
HF 8.708	HH 10.500	HK 4.705	H 0.657	C 29.620
LL 9.055	LM 8.661	AA NPT 2"	d1 A 4	d2 A 4

1 2 3 4 5 6 7 8

A
B
C
D
E
F

LOW VOLTAGE

HIGH VOLTAGE



CONNECTIONS FOR STARTING ONLY:

LOW VOLTAGE

HIGH VOLTAGE



Notes: Downloaded from <http://dealerselectric.com>
Generated for Model #02512ET3ECT324T-W22

Performed by:

Checked:

Customer:

W22 Cooling Tower Motors: NEMA Premium - TEFC

Three-phase induction motor
Frame 324T - IP55

23-SEP-2016

