



# Dealers Industrial Equipment

No.:

Date: 23-SEP-2016

Customer :

## TECHNICAL PROPOSAL

### Three-phase induction motor - Squirrel cage rotor

Product line : W22 NEMA Premium - Ball Bearings

Catalog Number : 02509ET3H326T-W22

List Price : \$7,315

#### Notes:

Downloaded from <http://dealerselectric.com>

Generated for Model #02509ET3H326T-W22

Performed by:

Checked:



# Dealers Industrial Equipment

No.:

Date: 23-SEP-2016

## DATA SHEET Three-phase induction motor - Squirrel cage rotor

Customer :  
Product line : W22 NEMA Premium - Ball Bearings

Frame : 324/6T  
Output : 25 HP  
Frequency : 60 Hz  
Poles : 8  
Full load speed : 880 rpm  
Slip : 2.22 %  
Voltage : 575 V  
Rated current : 28.7 A  
Locked rotor current : 149 A  
Locked rotor current (I<sub>L</sub>/I<sub>n</sub>) : 5.2  
No-load current : 16.0 A  
Full load torque : 147 lb.ft  
Locked rotor torque : 200 %  
Breakdown torque : 230 %  
Design : B  
Insulation class : F  
Temperature rise : 80 K  
Locked rotor time : 23 s (hot)  
Service factor : 1.25  
Duty cycle : S1  
Ambient temperature : -20°C - +40°C  
Altitude : 1000 m  
Degree of Protection : IP55  
Approximate weight : 509 lb  
Moment of inertia : 11.919 sq.ft.lb  
Noise level : 56 dB(A)

	D.E.	N.D.E.
Bearings	6312 C3	6212 C3
Regreasing interval	20000 h	20000 h
Grease amount	21 g	13 g

Load	Power factor	Efficiency (%)
100%	0.71	91.0
75%	0.64	91.0
50%	0.51	89.5

Notes:  
Downloaded from <http://dealerselectric.com>  
Generated for Model #02509ET3H326T-W22

Performed by

Checked



# Dealers Industrial Equipment

No.:

Date: 23-SEP-2016

## PERFORMANCE CURVES RELATED TO RATED OUTPUT

Three-phase induction motor - Squirrel cage rotor

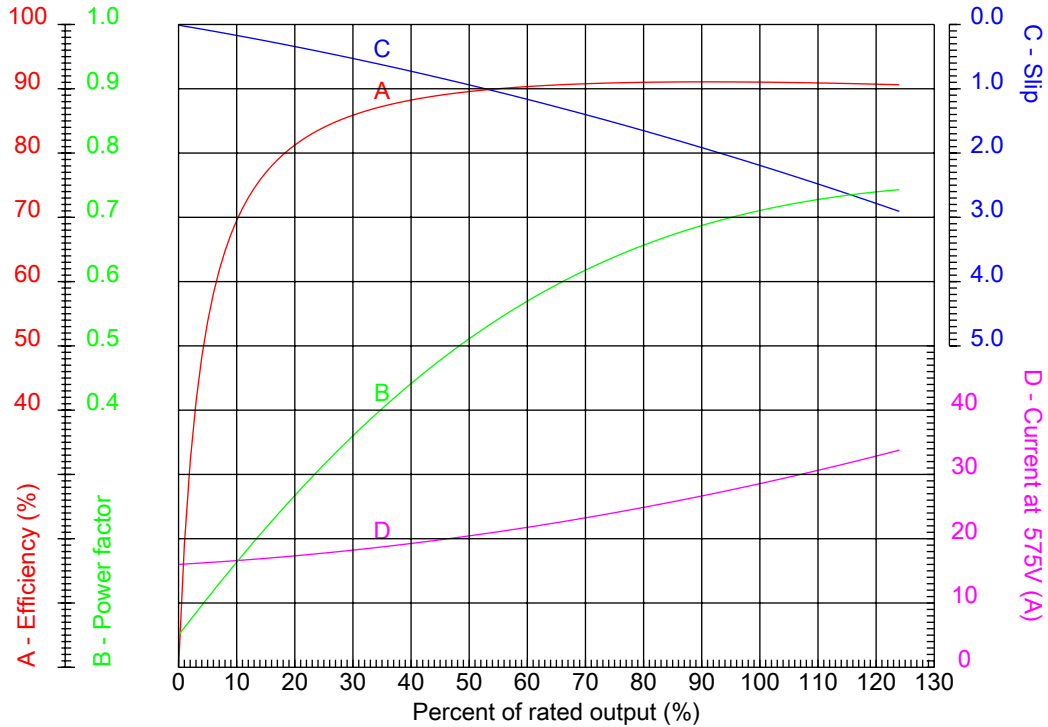

Customer :  
Product line : W22 NEMA Premium - Ball Bearings

Frame : 324/6T	Locked rotor current (I <sub>L</sub> /I <sub>n</sub> ) : 5.2
Output : 25 HP	Duty cycle : S1
Frequency : 60 Hz	Service factor : 1.25
Full load speed : 880 rpm	Design : B
Voltage : 575 V	Locked rotor torque : 200 %
Rated current : 28.7 A	Breakdown torque : 230 %
Insulation class : F	

Notes:  
Downloaded from <http://dealerselectric.com>  
Generated for Model #02509ET3H326T-W22

Performed by

Checked



# Dealers Industrial Equipment

No.:

Date: 23-SEP-2016

## CHARACTERISTIC CURVES RELATED TO SPEED

Three-phase induction motor - Squirrel cage rotor

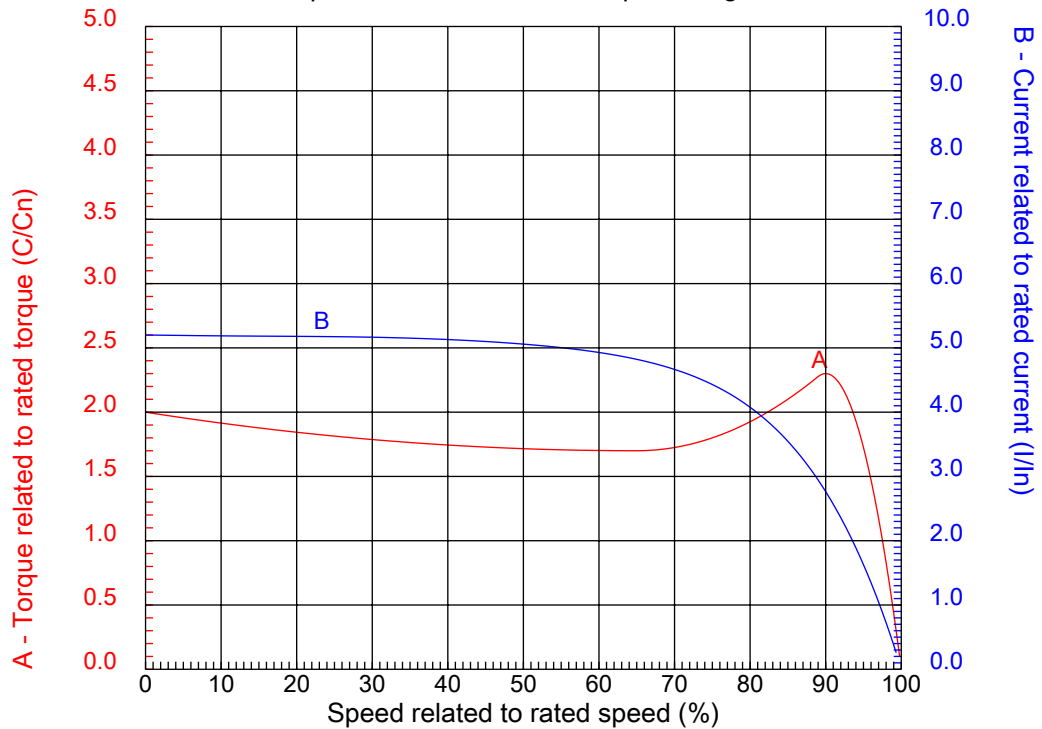

Customer :  
Product line : W22 NEMA Premium - Ball Bearings

Frame	: 324/6T	Locked rotor current (I <sub>l</sub> /I <sub>n</sub> )	: 5.2
Output	: 25 HP	Duty cycle	: S1
Frequency	: 60 Hz	Service factor	: 1.25
Full load speed	: 880 rpm	Design	: B
Voltage	: 575 V	Locked rotor torque	: 200 %
Rated current	: 28.7 A	Breakdown torque	: 230 %
Insulation class	: F		

Notes:  
Downloaded from <http://dealerselectric.com>  
Generated for Model #02509ET3H326T-W22

Performed by

Checked

1 2 3 4 5 6 7 8

A

B

C

D

E

F

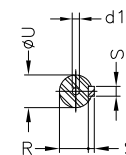
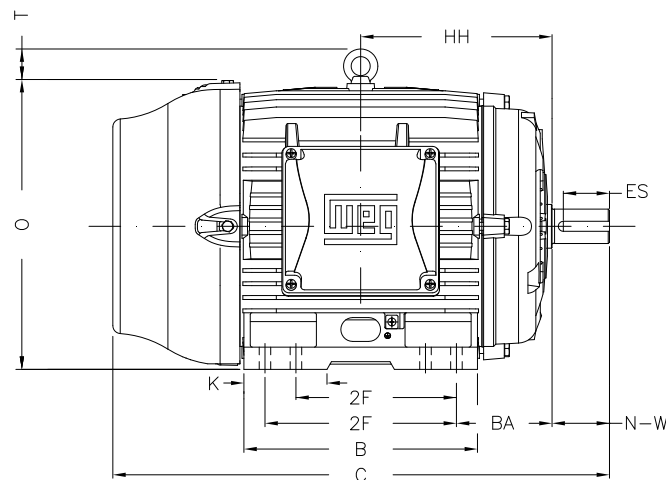
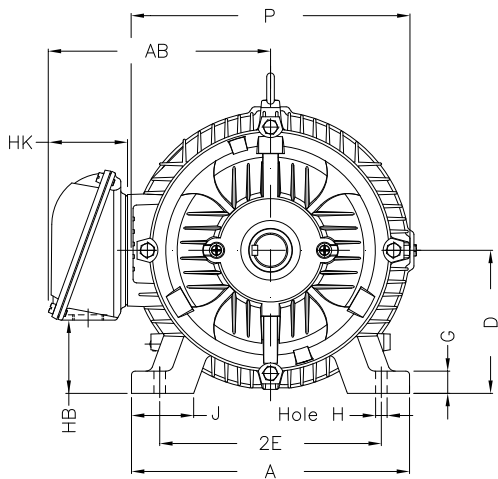
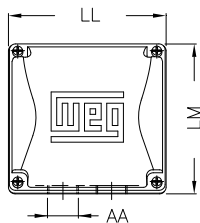

Notes: Downloaded from <http://dealerselectric.com>  
Generated for Model #02509ET3H326T-W22

2E 12.500	J 3.189	A 15.157	P 15.827	AB 12.575
2F 10.500/12.000	K 4.055	B 14.567	BA 5.250	FBA 8.738
U 2.125	N-W 5.250	ES 3.937	S 0.500	R 1.844
depth 0.500	D 8.000	G 1.300	HB 4.811	O 15.953
T 2.441	HF 8.708	HH 11.250	HK 4.705	H 0.657
C 31.116	FC 35.860	LL 9.055	LM 8.661	AA NPT 2"
d1 A 4				

Performed by:

Checked:

Customer:

W22 NEMA Premium - Ball Bearings

Three-phase induction motor  
Frame 324/6T - IP55

23-SEP-2016



1 2 3 4 5 6 7 8

A

B

C

D

E

F



Notes: Downloaded from <http://dealerselectric.com>  
Generated for Model #02509ET3H326T-W22

Performed by:

Checked:

Customer:

W22 NEMA Premium - Ball Bearings

Three-phase induction motor  
Frame 324/6T - IP55

23-SEP-2016

