



Dealers Industrial Equipment

No.:

Date: 23-SEP-2016

Customer :

TECHNICAL PROPOSAL

Three-phase induction motor - Squirrel cage rotor

Product line : W22 NEMA Premium - Ball Bearings

Catalog Number : 02509ET3E326T-W22

List Price : \$7,315

Notes:

Downloaded from <http://dealerselectric.com>

Generated for Model #02509ET3E326T-W22

Performed by:

Checked:



Dealers Industrial Equipment

No.:

Date: 23-SEP-2016

DATA SHEET Three-phase induction motor - Squirrel cage rotor

Customer :
Product line : W22 NEMA Premium - Ball Bearings

Frame : 324/6T
Output : 25 HP
Frequency : 60 Hz
Poles : 8
Full load speed : 880 rpm
Slip : 2.22 %
Voltage : 208-230/460 V
Rated current : 79.4-71.8/35.9 A
Locked rotor current : 373/187 A
Locked rotor current (I_L/I_n) : 5.2
No-load current : 40.0/20.0 A
Full load torque : 147 lb.ft
Locked rotor torque : 200 %
Breakdown torque : 230 %
Design : B
Insulation class : F
Temperature rise : 80 K
Locked rotor time : 23 s (hot)
Service factor : 1.25
Duty cycle : S1
Ambient temperature : -20°C - +40°C
Altitude : 1000 m
Degree of Protection : IP55
Approximate weight : 509 lb
Moment of inertia : 11.919 sq.ft.lb
Noise level : 56 dB(A)

	D.E.	N.D.E.
Bearings	6312 C3	6212 C3
Regreasing interval	20000 h	20000 h
Grease amount	21 g	13 g

Load	Power factor	Efficiency (%)
100%	0.71	91.0
75%	0.64	91.0
50%	0.51	89.5

Notes:
Downloaded from <http://dealerselectric.com>
Generated for Model #02509ET3E326T-W22

Performed by

Checked



Dealers Industrial Equipment

No.:

Date: 23-SEP-2016

PERFORMANCE CURVES RELATED TO RATED OUTPUT

Three-phase induction motor - Squirrel cage rotor

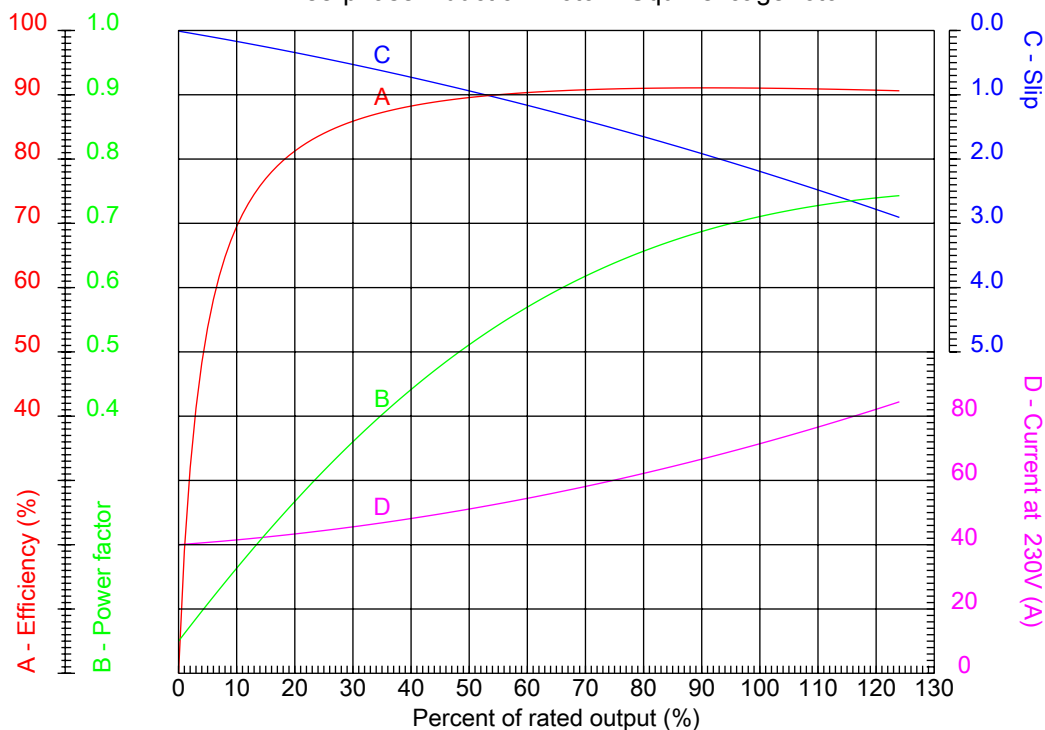

Customer :
Product line : W22 NEMA Premium - Ball Bearings

Frame	: 324/6T	Locked rotor current (I _l /I _n)	: 5.2
Output	: 25 HP	Duty cycle	: S1
Frequency	: 60 Hz	Service factor	: 1.25
Full load speed	: 880 rpm	Design	: B
Voltage	: 208-230/460 V	Locked rotor torque	: 200 %
Rated current	: 79.4-71.8/35.9 A	Breakdown torque	: 230 %
Insulation class	: F		

Notes:
Downloaded from <http://dealerselectric.com>
Generated for Model #02509ET3E326T-W22

Performed by

Checked



Dealers Industrial Equipment

No.:

Date: 23-SEP-2016

CHARACTERISTIC CURVES RELATED TO SPEED

Three-phase induction motor - Squirrel cage rotor

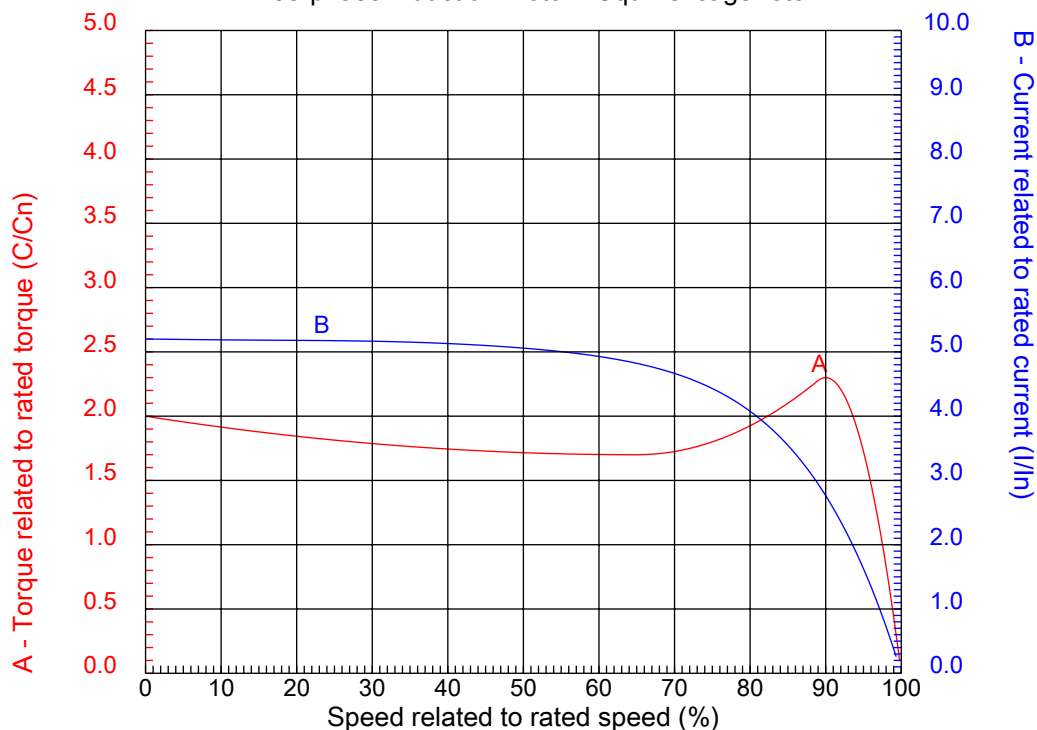

Customer :
Product line : W22 NEMA Premium - Ball Bearings

Frame	: 324/6T	Locked rotor current (I _l /I _n)	: 5.2
Output	: 25 HP	Duty cycle	: S1
Frequency	: 60 Hz	Service factor	: 1.25
Full load speed	: 880 rpm	Design	: B
Voltage	: 208-230/460 V	Locked rotor torque	: 200 %
Rated current	: 79.4-71.8/35.9 A	Breakdown torque	: 230 %
Insulation class	: F		

Notes:
Downloaded from <http://dealerselectric.com>
Generated for Model #02509ET3E326T-W22

Performed by

Checked

1 2 3 4 5 6 7 8

A
B
C
D
E
F

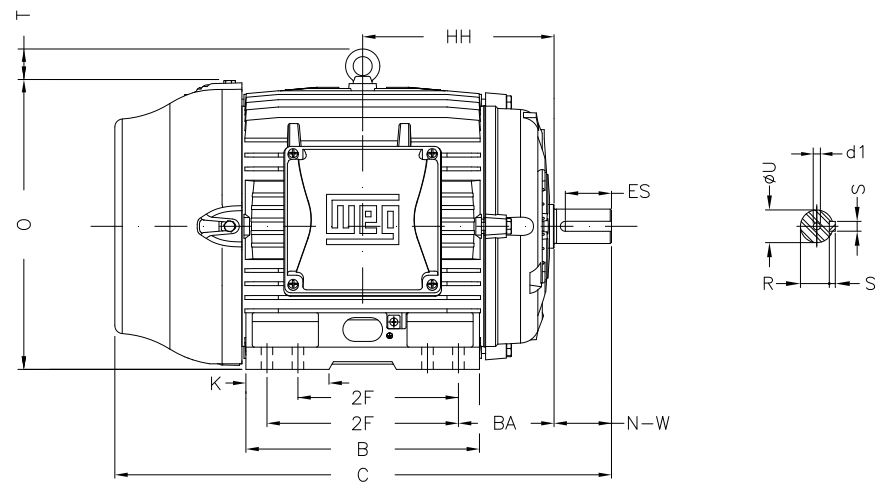
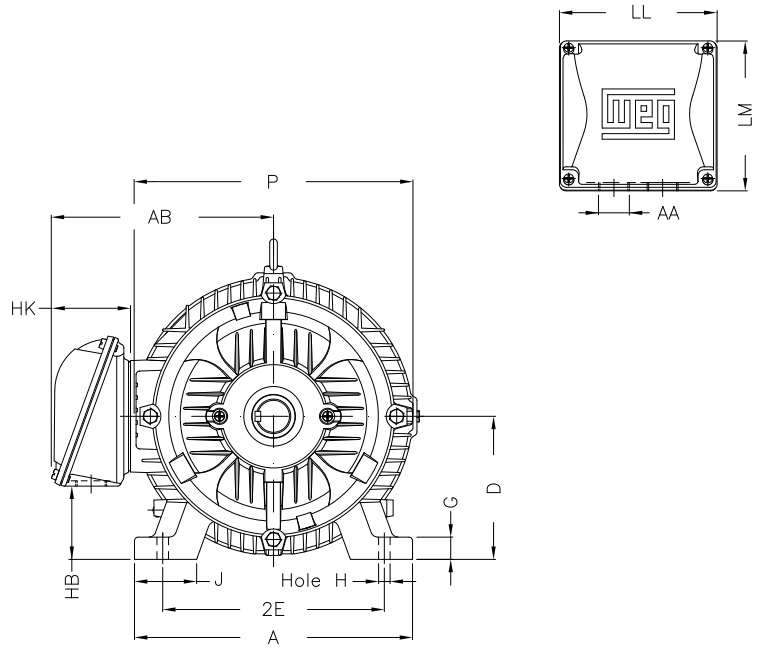

Notes: Downloaded from <http://dealerselectric.com>
Generated for Model #02509ET3E326T-W22

2E 12.500	J 3.189	A 15.157	P 15.827	AB 12.575
2F 10.500/12.000	K 4.055	B 14.567	BA 5.250	FBA 8.738
U 2.125	N-W 5.250	ES 3.937	S 0.500	R 1.844
depth 0.500	D 8.000	G 1.300	HB 4.811	O 15.953
T 2.441	HF 8.708	HH 11.250	HK 4.705	H 0.657
C 31.116	FC 35.860	LL 9.055	LM 8.661	AA NPT 2"
d1 A 4				

Performed by:
Checked:
Customer:
W22 NEMA Premium - Ball Bearings
Three-phase induction motor
Frame 324/6T - IP55

23-SEP-2016



1 2 3 4 5 6 7 8

A
B
C
D
E
F

LOW VOLTAGE

HIGH VOLTAGE



CONNECTIONS FOR STARTING ONLY:

LOW VOLTAGE

HIGH VOLTAGE



Notes: Downloaded from <http://dealerselectric.com>
Generated for Model #02509ET3E326T-W22

Performed by:

Checked:

Customer:

W22 NEMA Premium - Ball Bearings

Three-phase induction motor
Frame 324/6T - IP55

23-SEP-2016

