



# Dealers Industrial Equipment

No.:

Date: 23-SEP-2016

Customer :

## TECHNICAL PROPOSAL

### Three-phase induction motor - Squirrel cage rotor

Product line : Three-Phase : Rolled Steel Motor - NEMA Premium Efficiency

Catalog Number : 02036ET3ERS256TC

List Price : \$>(discontinued)</span>

#### Notes:

Downloaded from <http://dealerselectric.com>

Generated for Model #02036ET3ERS256TC

Performed by:

Checked:



# Dealers Industrial Equipment

No.:

Date: 23-SEP-2016

## DATA SHEET Three-phase induction motor - Squirrel cage rotor

Customer :  
 Product line : Three-Phase : Rolled Steel Motor - NEMA Premium Efficiency

Frame : 256T  
 Output : 20 HP  
 Frequency : 60 Hz  
 Poles : 2  
 Full load speed : 3530 rpm  
 Slip : 1.94 %  
 Voltage : 208-230/460 V  
 Rated current : 50.6-45.8/22.9 A  
 Locked rotor current : 284/142 A  
 Locked rotor current (I<sub>L</sub>/I<sub>n</sub>) : 6.2  
 No-load current : 13.8/6.88 A  
 Full load torque : 29.4 lb.ft  
 Locked rotor torque : 200 %  
 Breakdown torque : 250 %  
 Design : B  
 Insulation class : F  
 Temperature rise : 80 K  
 Locked rotor time : 26 s (hot)  
 Service factor : 1.15  
 Duty cycle : S1  
 Ambient temperature : -20°C - +40°C  
 Altitude : 1000 m  
 Degree of Protection : IP55  
 Approximate weight : 287 lb  
 Moment of inertia : 1.5356 sq.ft.lb  
 Noise level : ---

	D.E.	N.D.E.
Bearings	6309 ZZ	6209 ZZ
Regreasing interval	---	---
Grease amount	---	---

Load	Power factor	Efficiency (%)
100%	0.89	92.4
75%	0.86	92.4
50%	0.79	91.7

Notes:  
 Downloaded from <http://dealerselectric.com>  
 Generated for Model #02036ET3ERS256TC

Performed by

Checked



# Dealers Industrial Equipment

No.:

Date: 23-SEP-2016

## PERFORMANCE CURVES RELATED TO RATED OUTPUT

Three-phase induction motor - Squirrel cage rotor

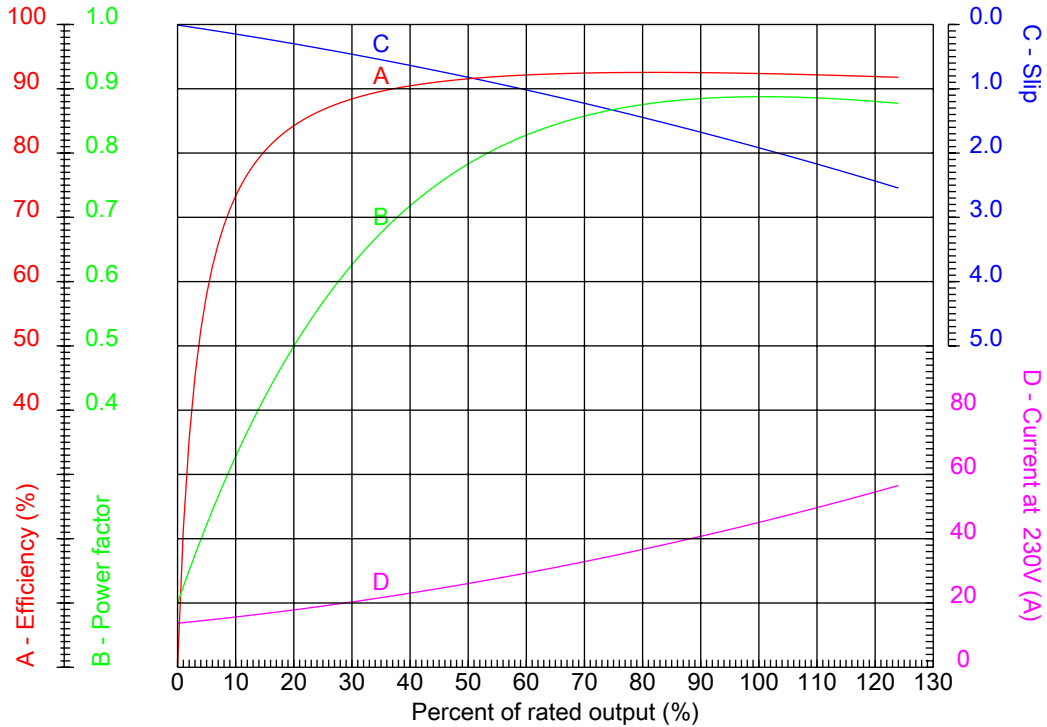

Customer :  
 Product line : Three-Phase : Rolled Steel Motor - NEMA Premium Efficiency

Frame : 256T	Locked rotor current (I <sub>l</sub> /I <sub>n</sub> ) : 6.2
Output : 20 HP	Duty cycle : S1
Frequency : 60 Hz	Service factor : 1.15
Full load speed : 3530 rpm	Design : B
Voltage : 208-230/460 V	Locked rotor torque : 200 %
Rated current : 50.6-45.8/22.9 A	Breakdown torque : 250 %
Insulation class : F	

Notes:  
 Downloaded from <http://dealerselectric.com>  
 Generated for Model #02036ET3ERS256TC

Performed by

Checked



# Dealers Industrial Equipment

No.:

Date: 23-SEP-2016

## CHARACTERISTIC CURVES RELATED TO SPEED

Three-phase induction motor - Squirrel cage rotor

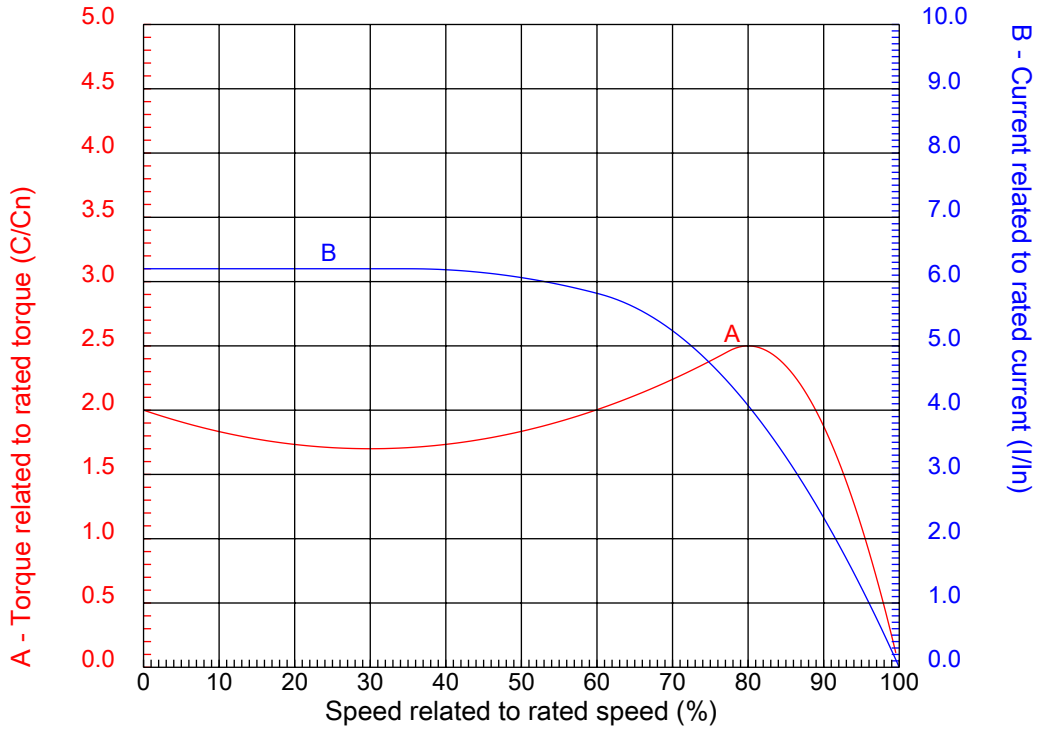

Customer :  
 Product line : Three-Phase : Rolled Steel Motor - NEMA Premium Efficiency

Frame	: 256T	Locked rotor current (I <sub>l</sub> /I <sub>n</sub> )	: 6.2
Output	: 20 HP	Duty cycle	: S1
Frequency	: 60 Hz	Service factor	: 1.15
Full load speed	: 3530 rpm	Design	: B
Voltage	: 208-230/460 V	Locked rotor torque	: 200 %
Rated current	: 50.6-45.8/22.9 A	Breakdown torque	: 250 %
Insulation class	: F		

Notes:  
 Downloaded from <http://dealerselectric.com>  
 Generated for Model #02036ET3ERS256TC

Performed by

Checked

1 2 3 4 5 6 7 8

A  
B  
C  
D  
E  
F

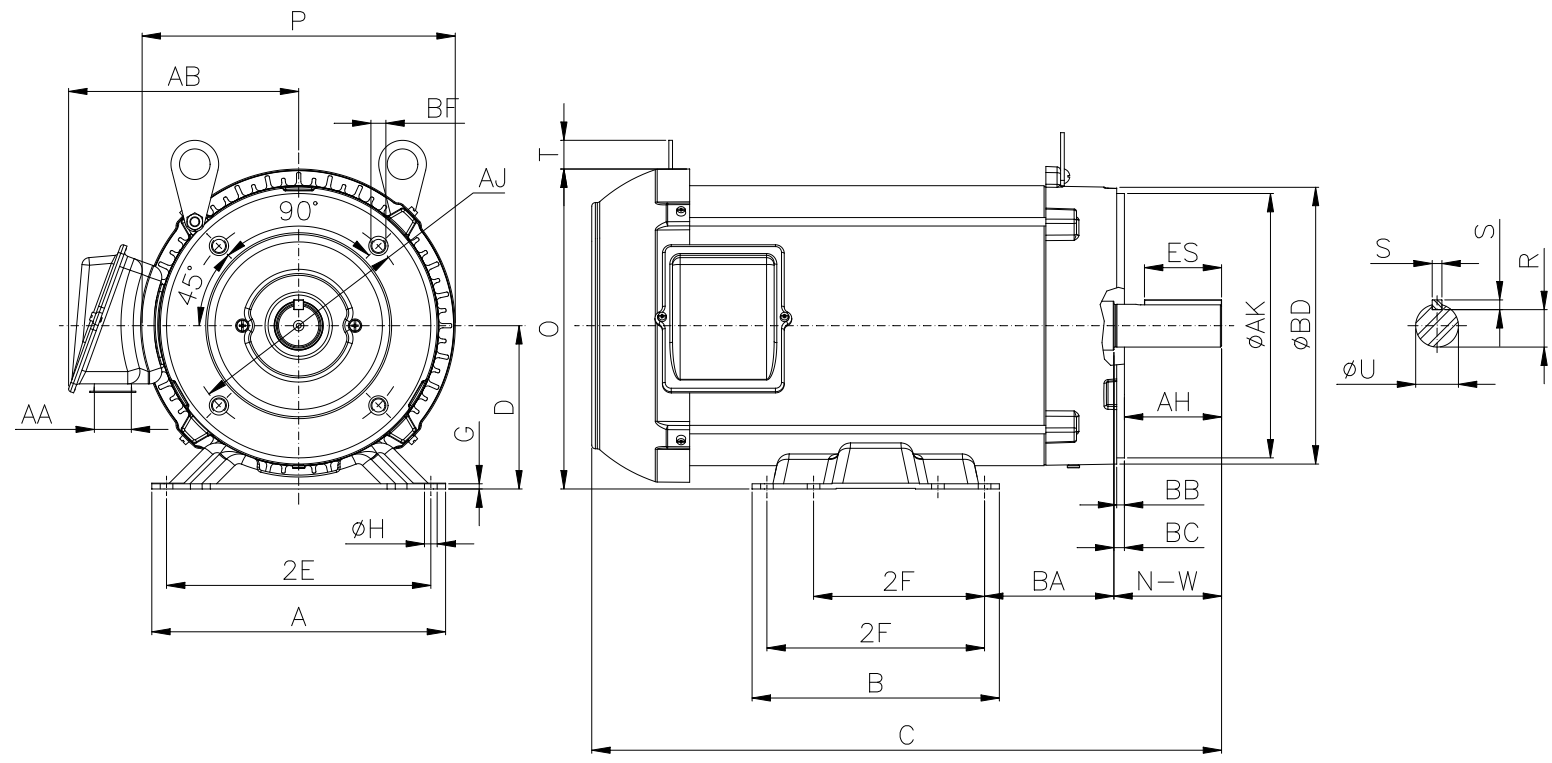

Notes: Downloaded from <http://dealerselectric.com>  
Generated for Model #02036ET3ERS256TC

Performed by:

Checked:

Customer:

Three-Phase : Rolled Steel Motor - NEMA Premium Efficiency

2E 10.000	A 12.126	P 11.181	AB 7.819	2F 8.252/10.000
B 11.417	BA 4.750	U 1.625	N-W 4.000	ES 2.756
S 0.375	R 1.416	depth 0.375	D 6.250	G 0.187
O 11.841	T 0.688	H 0.531	C 24.925	d1 A 4
d2 A 4	Flange FC-184	AJ 7.250	AK 8.500	BD 8.875
BF UNC 1/2"x13	BB 0.250	BC 0.250	AH 3.750	

Three-phase induction motor  
Frame 256T - IP55

23-SEP-2016



1 2 3 4 5 6 7 8

A  
B  
C  
D  
E  
F

LOW VOLTAGE

HIGH VOLTAGE

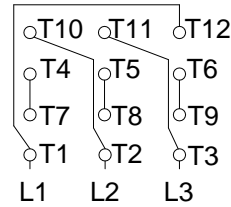
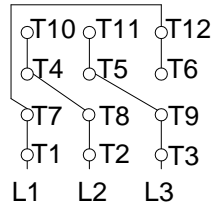

CONNECTIONS FOR STARTING ONLY:

LOW VOLTAGE

HIGH VOLTAGE

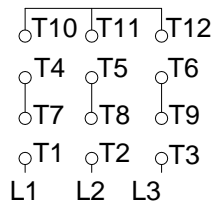
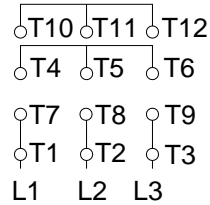

Notes: Downloaded from <http://dealerselectric.com>  
Generated for Model #02036ET3ERS256TC

Performed by:

Checked:

Customer:

Three-Phase : Rolled Steel Motor - NEMA Premium Efficiency

Three-phase induction motor  
Frame 256T - IP55

23-SEP-2016

