



Dealers Industrial Equipment

No.:

Date: 23-SEP-2016

Customer :

TECHNICAL PROPOSAL

Three-phase induction motor - Squirrel cage rotor

Product line : W22 NEMA Premium - Ball Bearings

Catalog Number : 02036ET3E256T-W22

List Price : \$2,382

Notes:

Downloaded from <http://dealerselectric.com>

Generated for Model #02036ET3E256T-W22

Performed by:

Checked:



Dealers Industrial Equipment

No.:

Date: 23-SEP-2016

DATA SHEET Three-phase induction motor - Squirrel cage rotor

Customer :
 Product line : W22 NEMA Premium - Ball Bearings

Frame : 254/6T
 Output : 20 HP
 Frequency : 60 Hz
 Poles : 2
 Full load speed : 3520 rpm
 Slip : 2.22 %
 Voltage : 208-230/460 V
 Rated current : 51.3-46.4/23.2 A
 Locked rotor current : 283/142 A
 Locked rotor current (I_L/I_n) : 6.1
 No-load current : 13.0/6.50 A
 Full load torque : 29.4 lb.ft
 Locked rotor torque : 200 %
 Breakdown torque : 240 %
 Design : B
 Insulation class : F
 Temperature rise : 80 K
 Locked rotor time : 21 s (hot)
 Service factor : 1.25
 Duty cycle : S1
 Ambient temperature : -20°C - +40°C
 Altitude : 1000 m
 Degree of Protection : IP55
 Approximate weight : 269 lb
 Moment of inertia : 1.5356 sq.ft.lb
 Noise level : 72 dB(A)

	D.E.	N.D.E.
Bearings	6309 C3	6209 C3
Regreasing interval	19000 h	20000 h
Grease amount	13 g	9 g

Load	Power factor	Efficiency (%)
100%	0.89	91.0
75%	0.87	91.7
50%	0.82	91.0

Notes:
 Downloaded from <http://dealerselectric.com>
 Generated for Model #02036ET3E256T-W22

Performed by

Checked



Dealers Industrial Equipment

No.:

Date: 23-SEP-2016

PERFORMANCE CURVES RELATED TO RATED OUTPUT Three-phase induction motor - Squirrel cage rotor

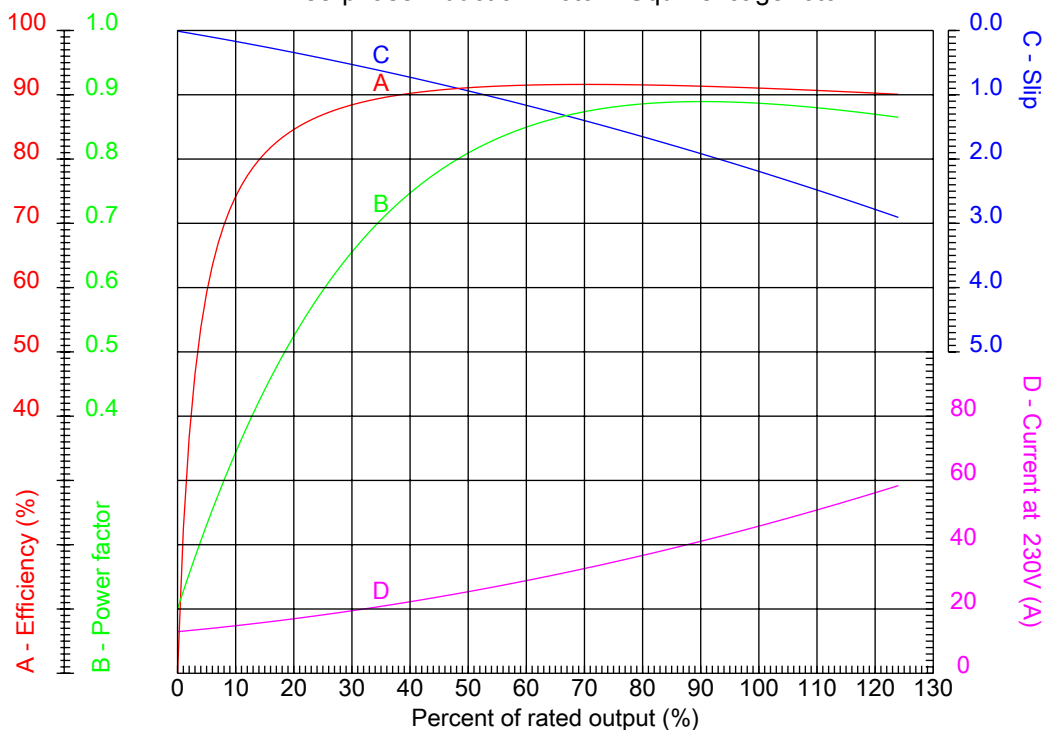

Customer :
 Product line : W22 NEMA Premium - Ball Bearings

Frame	: 254/6T	Locked rotor current (I _l /I _n)	: 6.1
Output	: 20 HP	Duty cycle	: S1
Frequency	: 60 Hz	Service factor	: 1.25
Full load speed	: 3520 rpm	Design	: B
Voltage	: 208-230/460 V	Locked rotor torque	: 200 %
Rated current	: 51.3-46.4/23.2 A	Breakdown torque	: 240 %
Insulation class	: F		

Notes:
 Downloaded from <http://dealerselectric.com>
 Generated for Model #02036ET3E256T-W22

Performed by

Checked



Dealers Industrial Equipment

No.:

Date: 23-SEP-2016

CHARACTERISTIC CURVES RELATED TO SPEED

Three-phase induction motor - Squirrel cage rotor

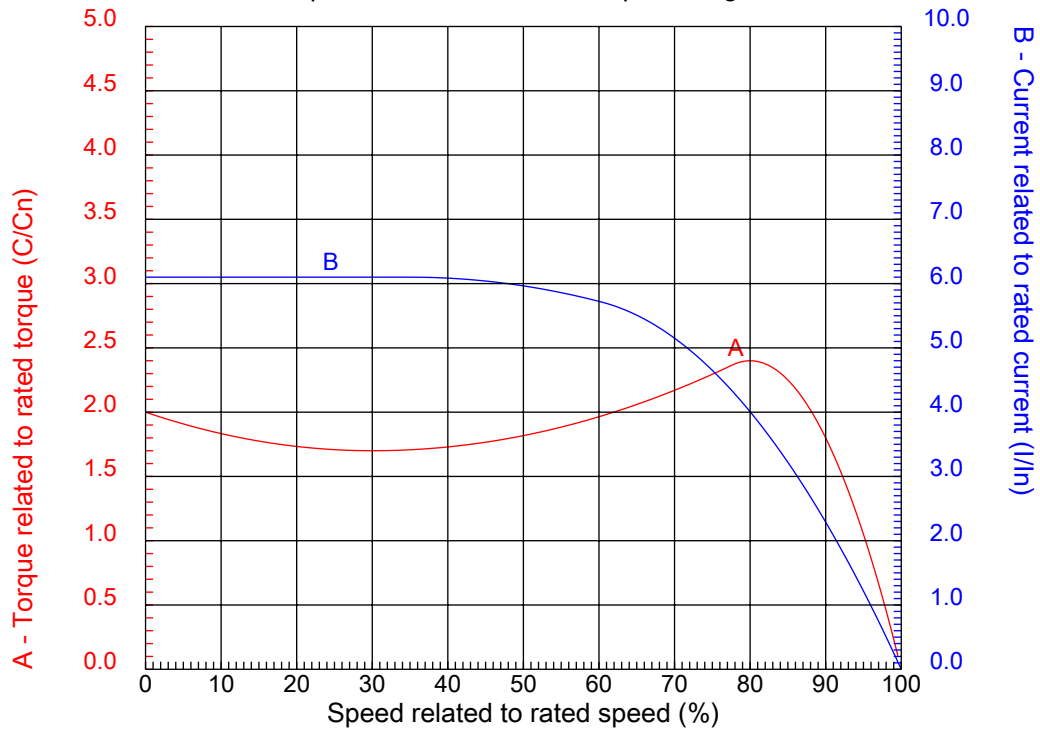

Customer :
Product line : W22 NEMA Premium - Ball Bearings

Frame	: 254/6T	Locked rotor current (I _l /I _n)	: 6.1
Output	: 20 HP	Duty cycle	: S1
Frequency	: 60 Hz	Service factor	: 1.25
Full load speed	: 3520 rpm	Design	: B
Voltage	: 208-230/460 V	Locked rotor torque	: 200 %
Rated current	: 51.3-46.4/23.2 A	Breakdown torque	: 240 %
Insulation class	: F		

Notes:
Downloaded from <http://dealerselectric.com>
Generated for Model #02036ET3E256T-W22

Performed by

Checked

1 2 3 4 5 6 7 8

A

B

C

D

E

F

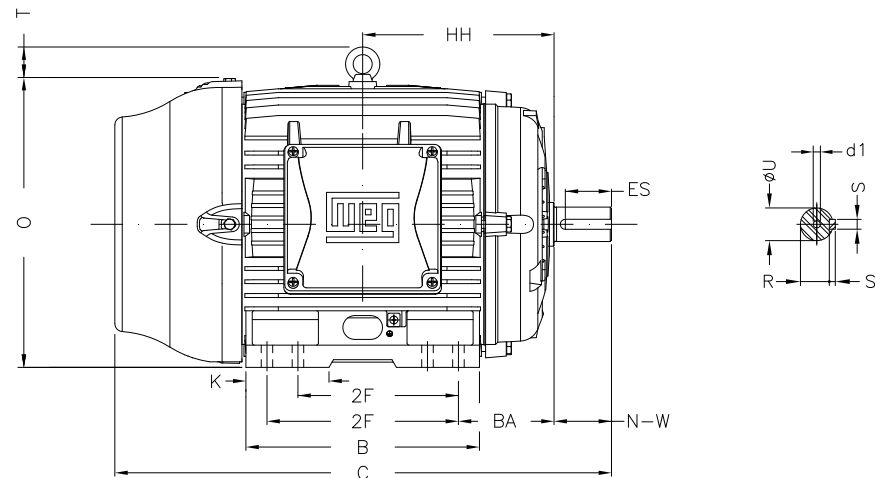
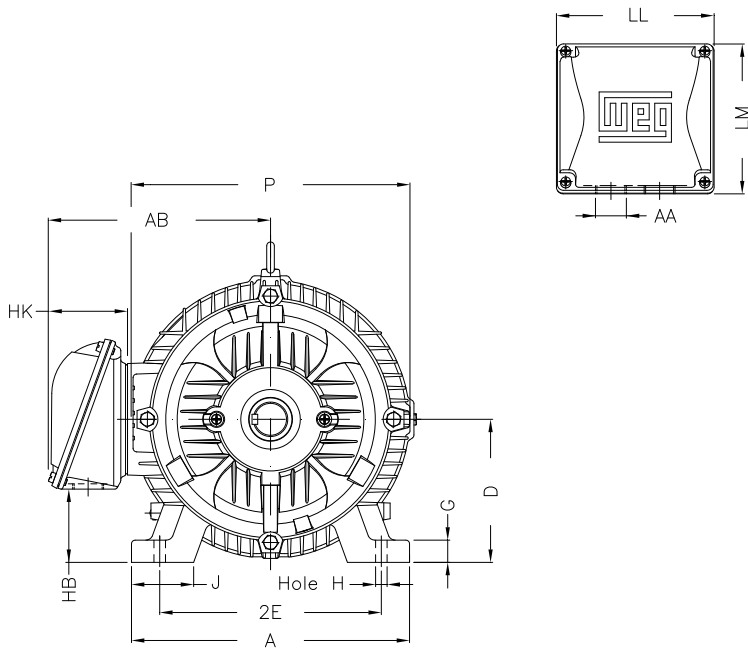

Notes: Downloaded from <http://dealerselectric.com>
Generated for Model #02036ET3E256T-W22

Performed by:

Checked:

Customer:

W22 NEMA Premium - Ball Bearings

Three-phase induction motor
Frame 254/6T - IP55

23-SEP-2016



2E 10.000	J 2.539	A 12.126	P 12.953	AB 10.483
2F 8.252/10.000	K 2.559	B 11.732	BA 4.250	FBA 6.852
U 1.625	N-W 4.000	ES 2.756	S 0.375	R 1.416
depth 0.375	D 6.250	G 0.827	HB 3.061	O 12.598
T 2.087	HF 6.565	HH 9.250	HK 3.976	H 0.531
C 24.945	LL 7.815	LM 7.480	AA NPT 1 1/2"	d1 A 4

1 2 3 4 5 6 7 8

A
B
C
D
E
F

LOW VOLTAGE

HIGH VOLTAGE



CONNECTIONS FOR STARTING ONLY:

LOW VOLTAGE

HIGH VOLTAGE



Notes: Downloaded from <http://dealerselectric.com>
Generated for Model #02036ET3E256T-W22

Performed by:

Checked:

Customer:

W22 NEMA Premium - Ball Bearings

Three-phase induction motor
Frame 254/6T - IP55

23-SEP-2016

