



Dealers Industrial Equipment

No.:

Date: 23-SEP-2016

Customer :

TECHNICAL PROPOSAL

Three-phase induction motor - Squirrel cage rotor

Product line : Three Phase: W01 (Rolled Steel) - TEFC - NEMA Premium Efficiency

Catalog Number : 02036ET3E256T-S

List Price : \$2,076

Notes:

Downloaded from <http://dealerselectric.com>

Generated for Model #02036ET3E256T-S

Performed by:

Checked:



Dealers Industrial Equipment

No.:

Date: 23-SEP-2016

DATA SHEET Three-phase induction motor - Squirrel cage rotor

Customer :
 Product line : Three Phase: W01 (Rolled Steel) - TEFC - NEMA Premium Efficiency

Frame : 254/6T
 Output : 20 HP
 Frequency : 60 Hz
 Poles : 2
 Full load speed : 3515 rpm
 Slip : 2.36 %
 Voltage : 208-230/460 V
 Rated current : 50.2-45.4/22.7 A
 Locked rotor current : 300/150 A
 Locked rotor current (I_L/I_n) : 6.6
 No-load current : 13.8/6.88 A
 Full load torque : 29.5 lb.ft
 Locked rotor torque : 200 %
 Breakdown torque : 290 %
 Design : B
 Insulation class : F
 Temperature rise : 80 K
 Locked rotor time : 12 s (hot)
 Service factor : 1.15
 Duty cycle : S1
 Ambient temperature : -20°C - +40°C
 Altitude : 1000 m
 Degree of Protection : IP55
 Approximate weight : 211 lb
 Moment of inertia : 1.2207 sq.ft.lb
 Noise level : 75 dB(A)

	D.E.	N.D.E.
Bearings	6309 Z-C3	6208 Z-C3
Regreasing interval	15797 h	20000 h
Grease amount	13 g	8 g

Load	Power factor	Efficiency (%)
100%	0.91	91.0
75%	0.88	91.0
50%	0.81	90.0

Notes:
 Downloaded from <http://dealerselectric.com>
 Generated for Model #02036ET3E256T-S

Performed by

Checked



Dealers Industrial Equipment

No.:

Date: 23-SEP-2016

PERFORMANCE CURVES RELATED TO RATED OUTPUT

Three-phase induction motor - Squirrel cage rotor

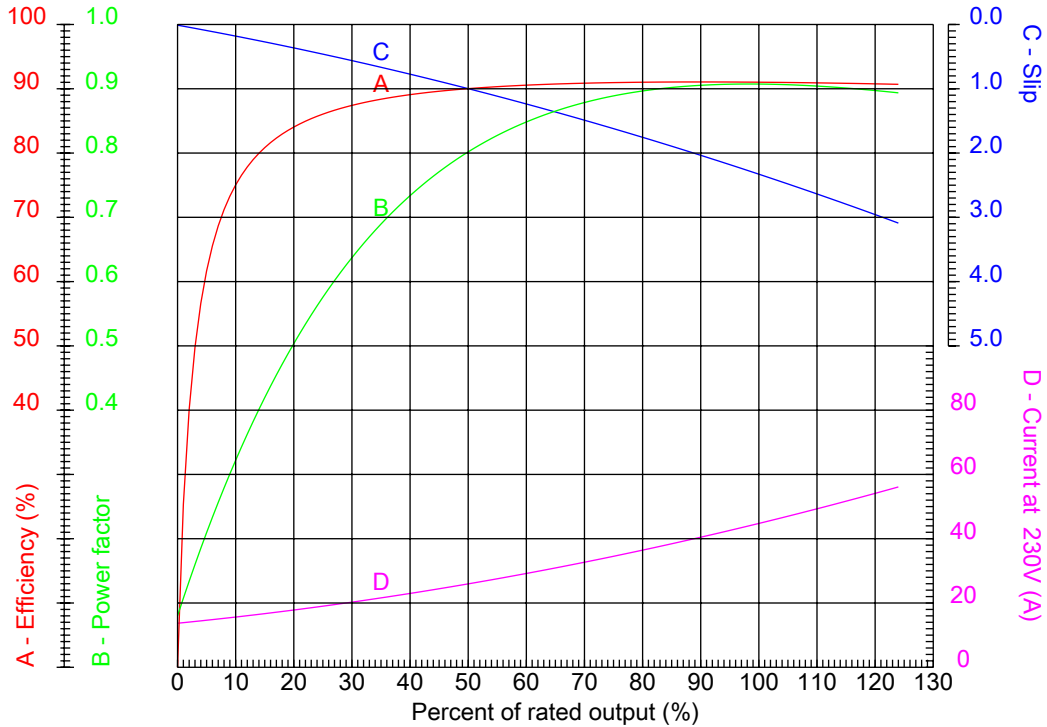

Customer :
 Product line : Three Phase: W01 (Rolled Steel) - TEFC - NEMA Premium Efficiency

Frame	: 254/6T	Locked rotor current (I _l /I _n)	: 6.6
Output	: 20 HP	Duty cycle	: S1
Frequency	: 60 Hz	Service factor	: 1.15
Full load speed	: 3515 rpm	Design	: B
Voltage	: 208-230/460 V	Locked rotor torque	: 200 %
Rated current	: 50.2-45.4/22.7 A	Breakdown torque	: 290 %
Insulation class	: F		

Notes:
 Downloaded from <http://dealerselectric.com>
 Generated for Model #02036ET3E256T-S

Performed by

Checked



CHARACTERISTIC CURVES RELATED TO SPEED

Three-phase induction motor - Squirrel cage rotor

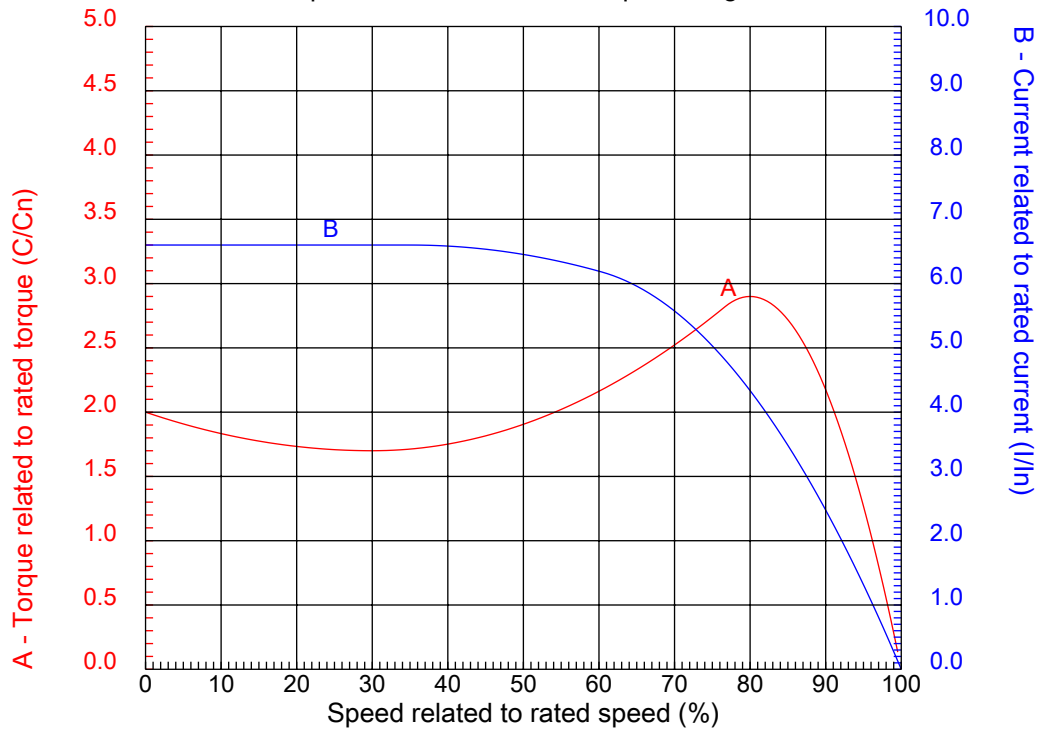

Customer :
Product line : Three Phase: W01 (Rolled Steel) - TEFC - NEMA Premium Efficiency

Frame	: 254/6T	Locked rotor current (I _l /I _n)	: 6.6
Output	: 20 HP	Duty cycle	: S1
Frequency	: 60 Hz	Service factor	: 1.15
Full load speed	: 3515 rpm	Design	: B
Voltage	: 208-230/460 V	Locked rotor torque	: 200 %
Rated current	: 50.2-45.4/22.7 A	Breakdown torque	: 290 %
Insulation class	: F		

Notes:
Downloaded from <http://dealerselectric.com>
Generated for Model #02036ET3E256T-S

Performed by

Checked

1 2 3 4 5 6 7 8

A

B

C

D

E

F

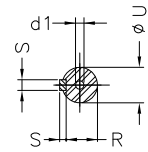
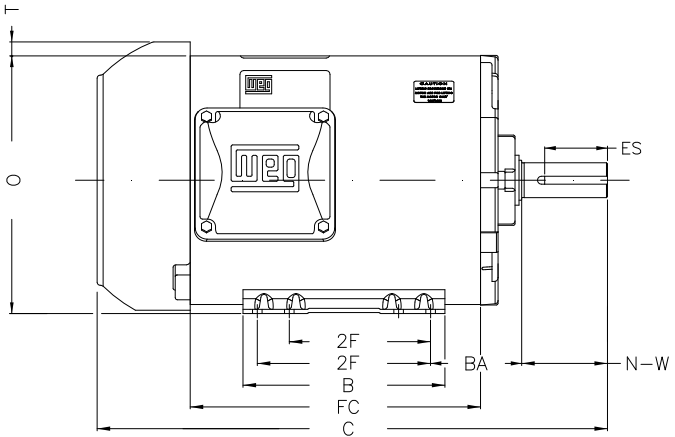
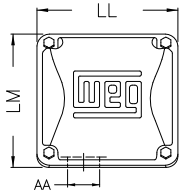
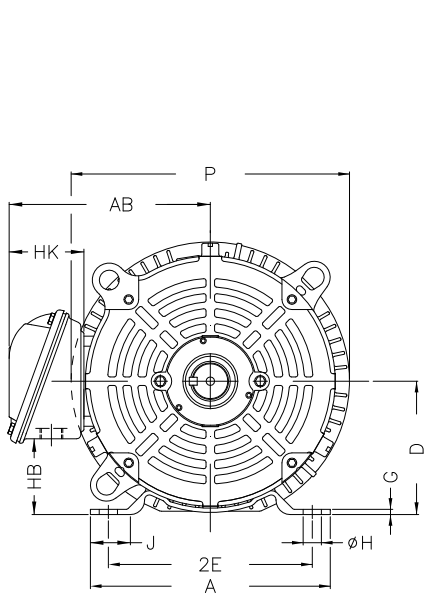

Notes: Downloaded from <http://dealerselectric.com>
Generated for Model #02036ET3E256T-S

Performed by:

Checked:

Customer:

Three Phase: W01 (Rolled Steel) - TEFC - NEMA Premium Efficiency

Three-phase induction motor
Frame 254/6T - IP55

23-SEP-2016



P	AB	J	2E	A
13.180	9.448	1.693	10.000	11.417
H	G	HB	HK	T
0.530	0.187	3.631	3.645	0.830
O	FC	2F	B	C
12.010	13.780	8.252/10.000	11.417	23.346
BA	N-W	ES	d1	S
4.250	4.000	2.756	A4	0.375
U	AA	depth	R	LL
1.625	1.732"	0.375	1.416	6.299
LM	BB	D	CH	
6.017	0.830	6.250	1.929	

1 2 3 4 5 6 7 8

A
B
C
D
E
F

LOW VOLTAGE

HIGH VOLTAGE



CONNECTIONS FOR STARTING ONLY:

LOW VOLTAGE

HIGH VOLTAGE



Notes: Downloaded from <http://dealerselectric.com>
Generated for Model #02036ET3E256T-S

Performed by:

Checked:

Customer:

Three Phase: W01 (Rolled Steel) - TEFC - NEMA Premium Efficiency

Three-phase induction motor
Frame 254/6T - IP55

23-SEP-2016

