



Dealers Industrial Equipment

No.:

Date: 23-SEP-2016

Customer :

TECHNICAL PROPOSAL

Three-phase induction motor - Squirrel cage rotor

Product line : Three Phase: W01 (Rolled Steel) - ODP - NEMA Premium Efficiency

Catalog Number : 02018OT3E256T-S

List Price : \$1,832

Notes:

Downloaded from <http://dealerselectric.com>

Generated for Model #02018OT3E256T-S

Performed by:

Checked:



Dealers Industrial Equipment

No.:

Date: 23-SEP-2016

DATA SHEET

Three-phase induction motor - Squirrel cage rotor

Customer :
 Product line : Three Phase: W01 (Rolled Steel) - ODP - NEMA Premium Efficiency

Frame : 254/6T
 Output : 20 HP
 Frequency : 60 Hz
 Poles : 4
 Full load speed : 1770 rpm
 Slip : 1.67 %
 Voltage : 208-230/460 V
 Rated current : 55.3-50.0/25.0 A
 Locked rotor current : 315/158 A
 Locked rotor current (I_L/I_n) : 6.3
 No-load current : 22.9/11.4 A
 Full load torque : 58.5 lb.ft
 Locked rotor torque : 240 %
 Breakdown torque : 290 %
 Design : B
 Insulation class : F
 Temperature rise : 80 K
 Locked rotor time : 15 s (hot)
 Service factor : 1.15
 Duty cycle : S1
 Ambient temperature : -20°C - +40°C
 Altitude : 1000 m
 Degree of Protection : ODP
 Approximate weight : 198 lb
 Moment of inertia : 2.2282 sq.ft.lb
 Noise level : 64 dB(A)

	D.E.	N.D.E.
Bearings	6309 Z-C3	6208 Z-C3
Regreasing interval	20000 h	20000 h
Grease amount	13 g	8 g

Load	Power factor	Efficiency (%)
100%	0.81	93.0
75%	0.74	92.4
50%	0.63	92.4

Notes:
 Downloaded from <http://dealerselectric.com>
 Generated for Model #02018OT3E256T-S

Performed by

Checked



Dealers Industrial Equipment

No.:

Date: 23-SEP-2016

PERFORMANCE CURVES RELATED TO RATED OUTPUT

Three-phase induction motor - Squirrel cage rotor

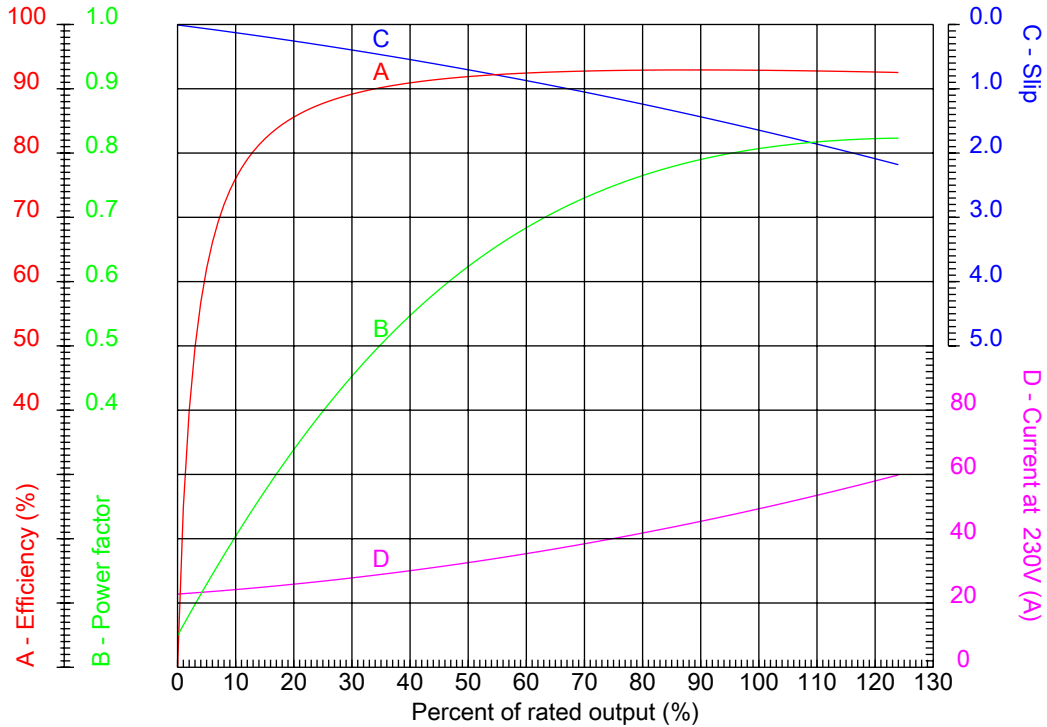

Customer :
 Product line : Three Phase: W01 (Rolled Steel) - ODP - NEMA Premium Efficiency

Frame	: 254/6T	Locked rotor current (I _l /I _n)	: 6.3
Output	: 20 HP	Duty cycle	: S1
Frequency	: 60 Hz	Service factor	: 1.15
Full load speed	: 1770 rpm	Design	: B
Voltage	: 208-230/460 V	Locked rotor torque	: 240 %
Rated current	: 55.3-50.0/25.0 A	Breakdown torque	: 290 %
Insulation class	: F		

Notes:
 Downloaded from <http://dealerselectric.com>
 Generated for Model #02018OT3E256T-S

Performed by

Checked



Dealers Industrial Equipment

No.:

Date: 23-SEP-2016

CHARACTERISTIC CURVES RELATED TO SPEED

Three-phase induction motor - Squirrel cage rotor

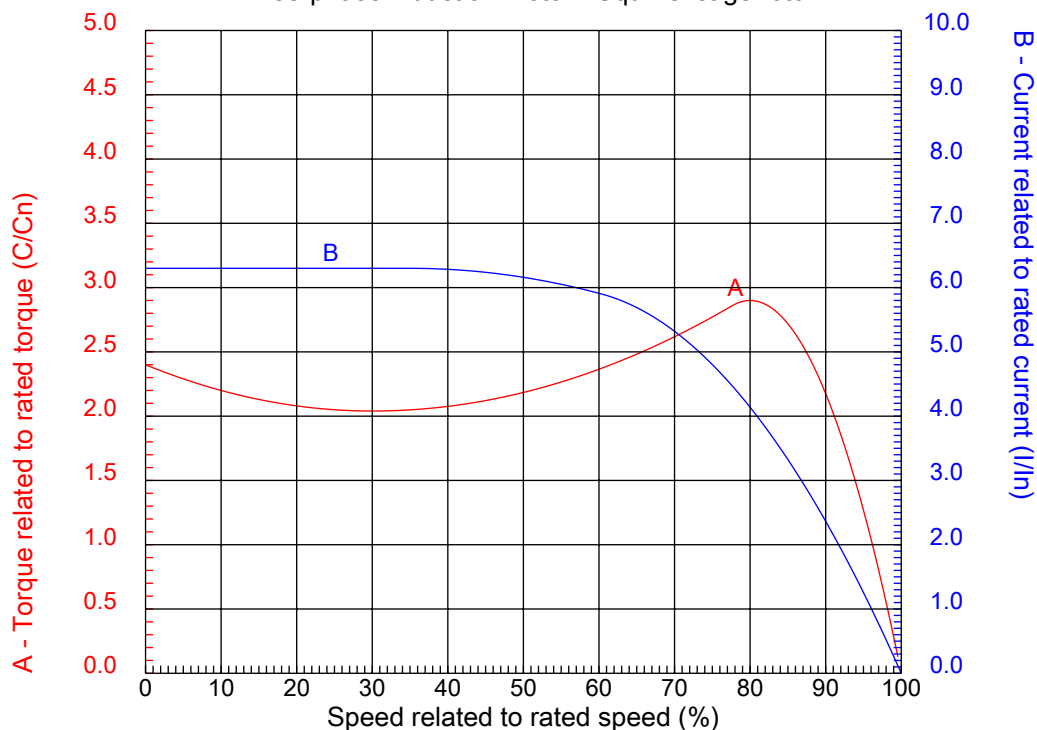

Customer :
Product line : Three Phase: W01 (Rolled Steel) - ODP - NEMA Premium Efficiency

Frame	: 254/6T	Locked rotor current (I _l /I _n)	: 6.3
Output	: 20 HP	Duty cycle	: S1
Frequency	: 60 Hz	Service factor	: 1.15
Full load speed	: 1770 rpm	Design	: B
Voltage	: 208-230/460 V	Locked rotor torque	: 240 %
Rated current	: 55.3-50.0/25.0 A	Breakdown torque	: 290 %
Insulation class	: F		

Notes:
Downloaded from <http://dealerselectric.com>
Generated for Model #02018OT3E256T-S

Performed by

Checked

1 2 3 4 5 6 7 8

A

B

C

D

E

F

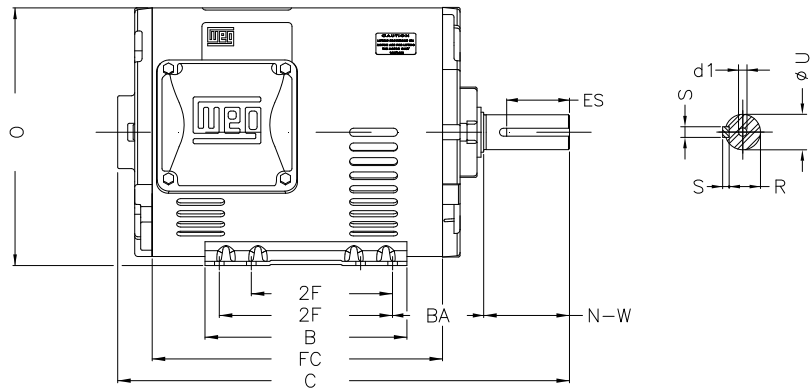
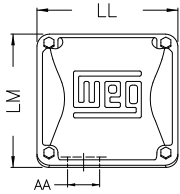
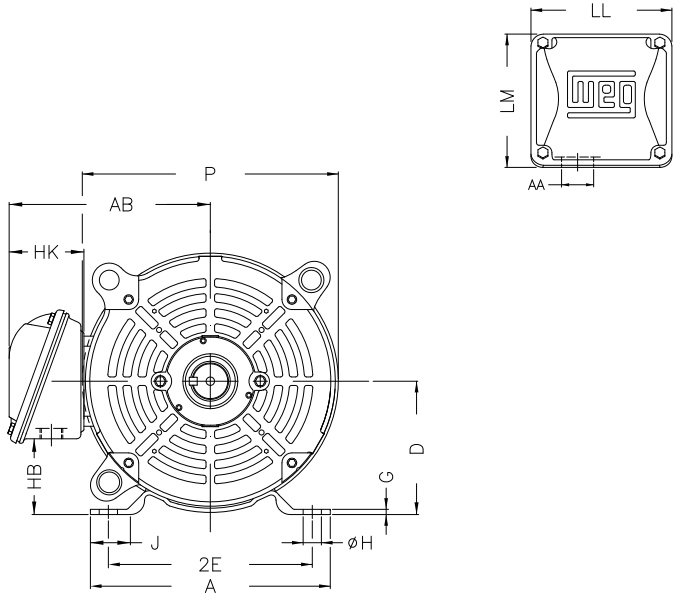

Notes: Downloaded from <http://dealerselectric.com>
Generated for Model #020180T3E256T-S

Performed by:

Checked:

Customer:

Three Phase: W01 (Rolled Steel) - ODP - NEMA Premium Efficiency

P	AB	J	2E	A
11.558	9.448	1.693	10.000	11.417
H	G	HB	HK	T
0.530	0.187	3.631	3.645	0.019
O	FC	2F	B	C
12.010	12.992	8.252/10.000	11.417	20.472
BA	N-W	ES	d1	S
4.250	4.000	2.756	A4	0.375
U	AA	depth	R	LL
1.625	1.732"	0.375	1.416	6.299
LM	BB	D	CH	
6.017	0.019	6.250	1.929	

Three-phase induction motor
Frame 254/6T - ODP

23-SEP-2016



1 2 3 4 5 6 7 8

A
B
C
D
E
F

LOW VOLTAGE

HIGH VOLTAGE



CONNECTIONS FOR STARTING ONLY:

LOW VOLTAGE

HIGH VOLTAGE



Notes: Downloaded from <http://dealerselectric.com>
Generated for Model #02018OT3E256T-S

Performed by:

Checked:

Customer:

Three Phase: W01 (Rolled Steel) - ODP - NEMA Premium Efficiency

Three-phase induction motor
Frame 254/6T - IP21

23-SEP-2016

