



Dealers Industrial Equipment

No.:

Date: 23-SEP-2016

Customer :

TECHNICAL PROPOSAL

Three-phase induction motor - Squirrel cage rotor

Product line : W22 NEMA Premium - Ball Bearings

Catalog Number : 02018ET3E256TC-W22

List Price : \$2,270

Notes:

Downloaded from <http://dealerselectric.com>

Generated for Model #02018ET3E256TC-W22

Performed by:

Checked:



Dealers Industrial Equipment

No.:

Date: 23-SEP-2016

DATA SHEET Three-phase induction motor - Squirrel cage rotor

Customer :
 Product line : W22 NEMA Premium - Ball Bearings

Frame : 254/6T
 Output : 20 HP
 Frequency : 60 Hz
 Poles : 4
 Full load speed : 1765 rpm
 Slip : 1.94 %
 Voltage : 208-230/460 V
 Rated current : 53.3-48.2/24.1 A
 Locked rotor current : 333/166 A
 Locked rotor current (I_L/I_n) : 6.9
 No-load current : 20.0/10.0 A
 Full load torque : 58.7 lb.ft
 Locked rotor torque : 230 %
 Breakdown torque : 270 %
 Design : B
 Insulation class : F
 Temperature rise : 80 K
 Locked rotor time : 15 s (hot)
 Service factor : 1.25
 Duty cycle : S1
 Ambient temperature : -20°C - +40°C
 Altitude : 1000 m
 Degree of Protection : IP55
 Approximate weight : 291 lb
 Moment of inertia : 3.0963 sq.ft.lb
 Noise level : 64 dB(A)

	D.E.	N.D.E.
Bearings	6309 C3	6209 C3
Regreasing interval	20000 h	20000 h
Grease amount	13 g	9 g

Load	Power factor	Efficiency (%)
100%	0.84	93.0
75%	0.79	92.4
50%	0.68	91.7

Notes:
 Downloaded from <http://dealerselectric.com>
 Generated for Model #02018ET3E256TC-W22

Performed by

Checked



Dealers Industrial Equipment

No.:

Date: 23-SEP-2016

PERFORMANCE CURVES RELATED TO RATED OUTPUT

Three-phase induction motor - Squirrel cage rotor

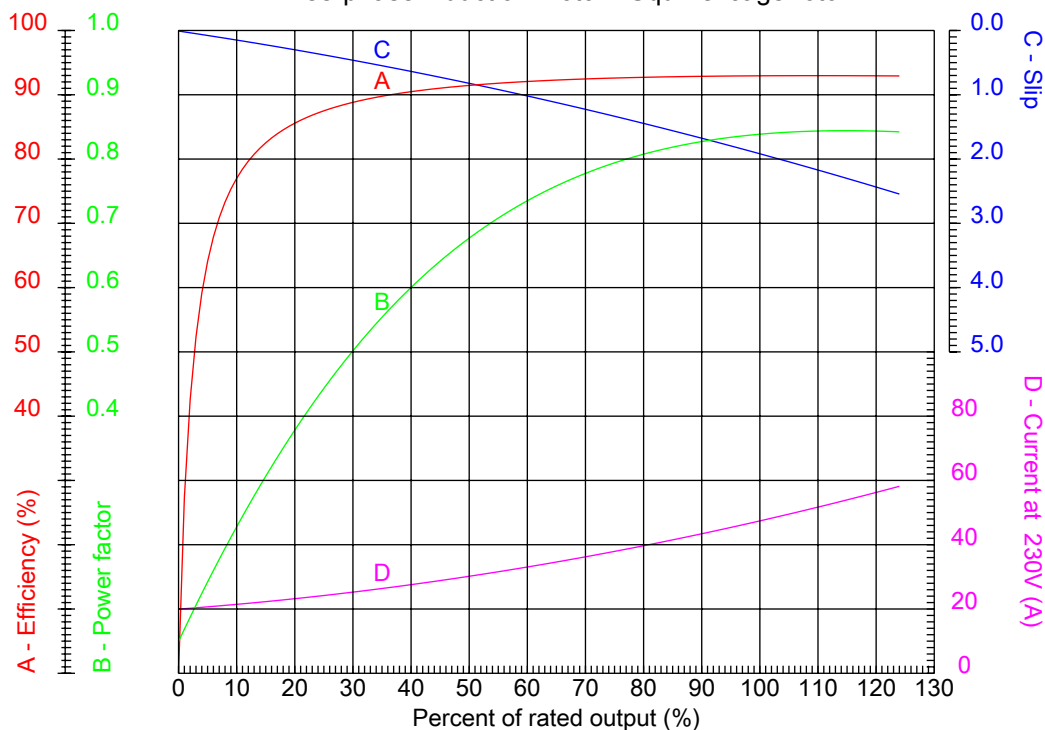

Customer :
Product line : W22 NEMA Premium - Ball Bearings

Frame	: 254/6T	Locked rotor current (I _l /I _n)	: 6.9
Output	: 20 HP	Duty cycle	: S1
Frequency	: 60 Hz	Service factor	: 1.25
Full load speed	: 1765 rpm	Design	: B
Voltage	: 208-230/460 V	Locked rotor torque	: 230 %
Rated current	: 53.3-48.2/24.1 A	Breakdown torque	: 270 %
Insulation class	: F		

Notes:
Downloaded from <http://dealerselectric.com>
Generated for Model #02018ET3E256TC-W22

Performed by

Checked



Dealers Industrial Equipment

No.:

Date: 23-SEP-2016

CHARACTERISTIC CURVES RELATED TO SPEED

Three-phase induction motor - Squirrel cage rotor

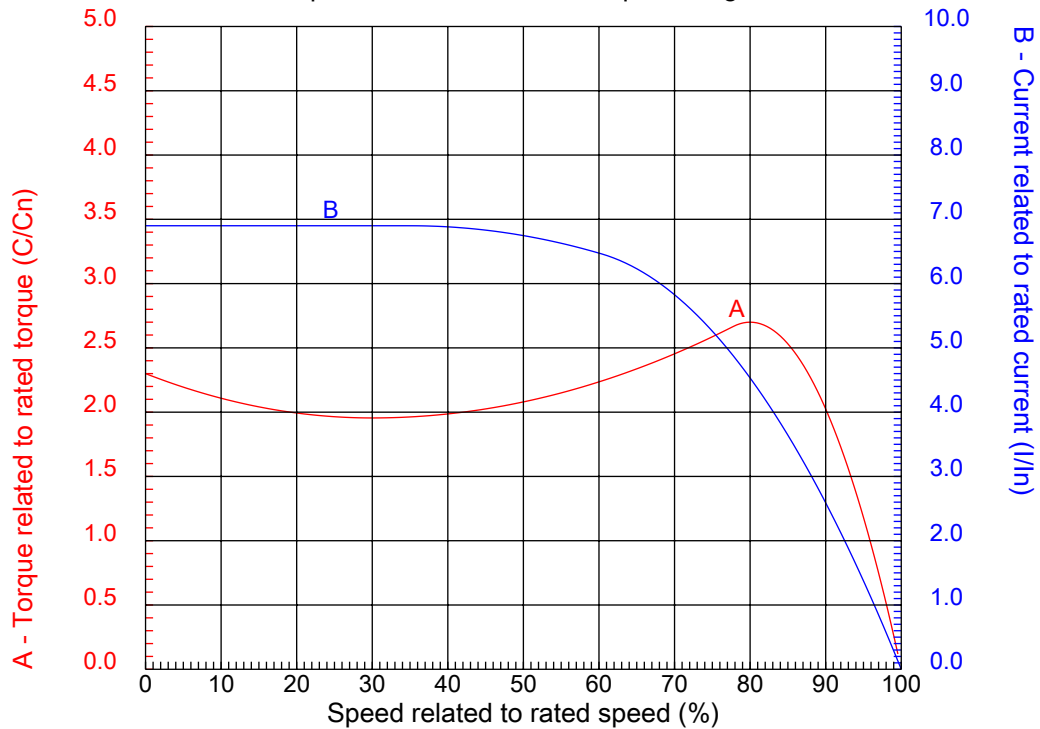

Customer :
Product line : W22 NEMA Premium - Ball Bearings

Frame	: 254/6T	Locked rotor current (I _l /I _n)	: 6.9
Output	: 20 HP	Duty cycle	: S1
Frequency	: 60 Hz	Service factor	: 1.25
Full load speed	: 1765 rpm	Design	: B
Voltage	: 208-230/460 V	Locked rotor torque	: 230 %
Rated current	: 53.3-48.2/24.1 A	Breakdown torque	: 270 %
Insulation class	: F		

Notes:
Downloaded from <http://dealerselectric.com>
Generated for Model #02018ET3E256TC-W22

Performed by

Checked

1 2 3 4 5 6 7 8

A

B

C

D

E

F

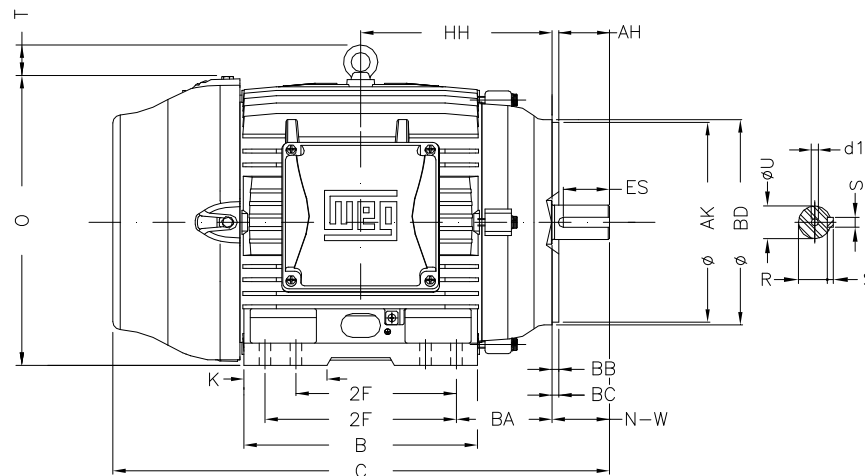
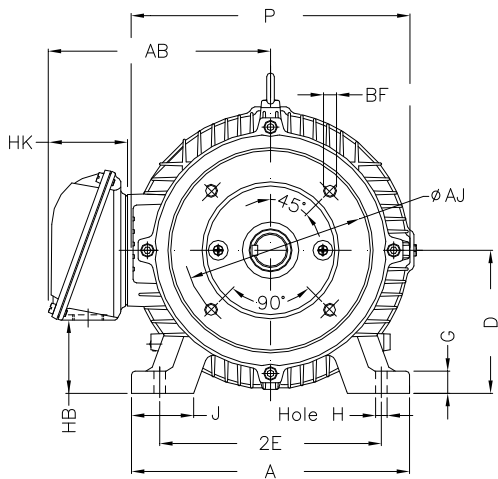
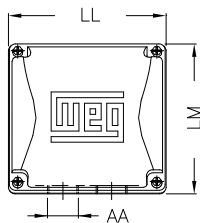

Notes: Downloaded from <http://dealerselectric.com>
Generated for Model #02018ET3E256TC-W22

2E	J	A	P	AB
10.000	2.539	12.126	12.953	10.483
2F	K	B	BA	FBA
8.252/10.000	2.559	11.732	4.250	6.852
U	N-W	ES	S	R
1.625	4.000	2.756	0.375	1.416
depth	D	G	HB	O
0.375	6.250	0.827	3.061	12.598
T	HF	HH	HK	H
2.087	6.565	9.250	3.976	0.531
C	LL	LM	AA	d1
24.945	7.815	7.480	NPT 1 1/2"	A 4
Flange	AJ	AK	BD	BF
FC-184	7.250	8.500	8.875	UNC 1/2"x13
BB	BC	AH		
0.250	0.250	3.750		

Performed by:

Checked:

Customer:

W22 NEMA Premium - Ball Bearings

Three-phase induction motor
Frame 254/6T - IP55

23-SEP-2016



1 2 3 4 5 6 7 8

A
B
C
D
E
F

LOW VOLTAGE

HIGH VOLTAGE

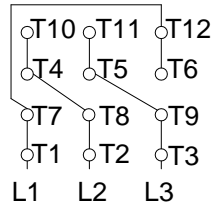

CONNECTIONS FOR STARTING ONLY:

LOW VOLTAGE

HIGH VOLTAGE



Notes: Downloaded from <http://dealerselectric.com>
Generated for Model #02018ET3E256TC-W22

Performed by:

Checked:

Customer:

W22 NEMA Premium - Ball Bearings

Three-phase induction motor
Frame 254/6T - IP55

23-SEP-2016

