



Dealers Industrial Equipment

No.:

Date: 23-SEP-2016

Customer :

TECHNICAL PROPOSAL

Three-phase induction motor - Squirrel cage rotor

Product line : Three-Phase: W22 IE3 IEC Tru-Metric - TEFC (IP55) Cast Iron Frame

Catalog Number : 01818ET3Y180M-W22

List Price : \$2,689

Notes:

Downloaded from <http://dealerselectric.com>

Generated for Model #01818ET3Y180M-W22

Performed by:

Checked:



Dealers Industrial Equipment

No.:

Date: 23-SEP-2016

DATA SHEET

Three-phase induction motor - Squirrel cage rotor

Customer :
 Product line : Three-Phase: W22 IE3 IEC Tru-Metric - TEFC (IP55) Cast Iron Frame

Frame : 180M
 Output : 25 HP
 Frequency : 60 Hz
 Poles : 4
 Full load speed : 1775 rpm
 Slip : 1.39 %
 Voltage : 460 V
 Rated current : 30.6 A
 Locked rotor current : 248 A
 Locked rotor current (I_L/I_n) : 8.1
 No-load current : 15.2 A
 Full load torque : 73.0 lb.ft
 Locked rotor torque : 330 %
 Breakdown torque : 380 %
 Design : ---
 Insulation class : F
 Temperature rise : 80 K
 Locked rotor time : 21 s (hot)
 Service factor : 1.25
 Duty cycle : S1
 Ambient temperature : -20°C - +40°C
 Altitude : 1000 m
 Degree of Protection : IP55
 Approximate weight : 397 lb
 Moment of inertia : 4.7491 sq.ft.lb
 Noise level : 64 dB(A)

	D.E.	N.D.E.
Bearings	6311 C3	6211 C3
Regreasing interval	20000 h	20000 h
Grease amount	18 g	11 g

Load	Power factor	Efficiency (%)
100%	0.81	93.6
75%	0.75	92.4
50%	0.62	91.0

Notes:
 Downloaded from <http://dealerselectric.com>
 Generated for Model #01818ET3Y180M-W22

Performed by

Checked



Dealers Industrial Equipment

No.:

Date: 23-SEP-2016

PERFORMANCE CURVES RELATED TO RATED OUTPUT

Three-phase induction motor - Squirrel cage rotor

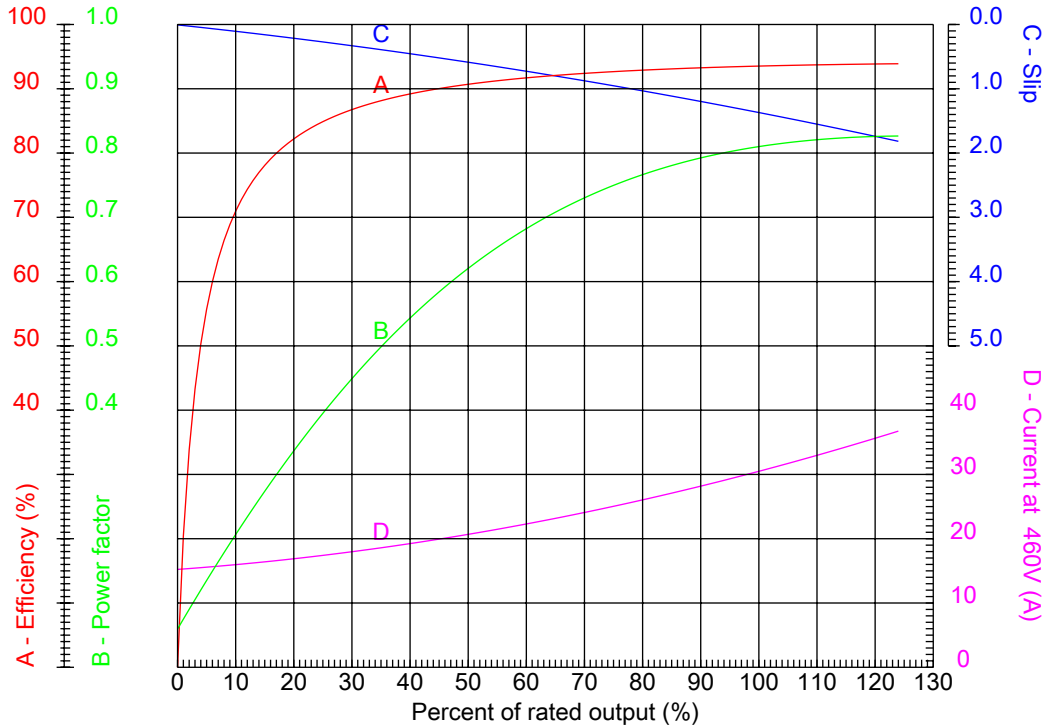

Customer :
 Product line : Three-Phase: W22 IE3 IEC Tru-Metric - TEFC (IP55) Cast Iron Frame

Frame : 180M	Locked rotor current (I _l /I _n) : 8.1
Output : 25 HP	Duty cycle : S1
Frequency : 60 Hz	Service factor : 1.25
Full load speed : 1775 rpm	Design : ---
Voltage : 460 V	Locked rotor torque : 330 %
Rated current : 30.6 A	Breakdown torque : 380 %
Insulation class : F	

Notes:
 Downloaded from <http://dealerselectric.com>
 Generated for Model #01818ET3Y180M-W22

Performed by

Checked



Dealers Industrial Equipment

No.:

Date: 23-SEP-2016

CHARACTERISTIC CURVES RELATED TO SPEED

Three-phase induction motor - Squirrel cage rotor

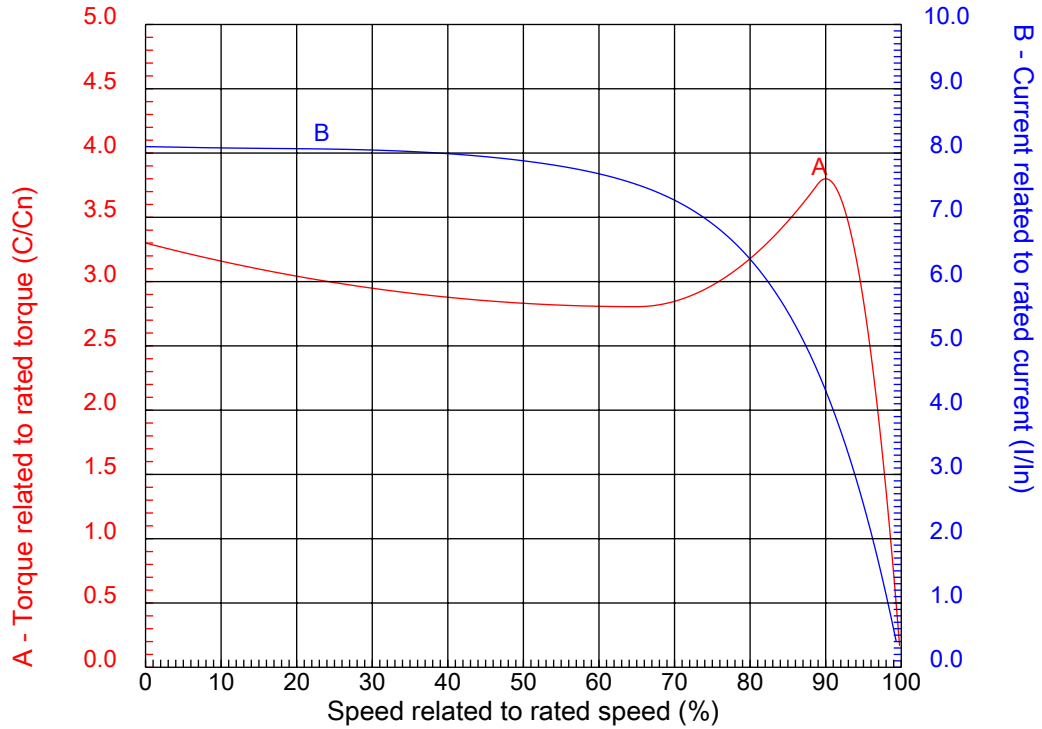

Customer :
Product line : Three-Phase: W22 IE3 IEC Tru-Metric - TEFC (IP55) Cast Iron Frame

Frame	: 180M	Locked rotor current (I _l /I _n)	: 8.1
Output	: 25 HP	Duty cycle	: S1
Frequency	: 60 Hz	Service factor	: 1.25
Full load speed	: 1775 rpm	Design	: ---
Voltage	: 460 V	Locked rotor torque	: 330 %
Rated current	: 30.6 A	Breakdown torque	: 380 %
Insulation class	: F		

Notes:
Downloaded from <http://dealerselectric.com>
Generated for Model #01818ET3Y180M-W22

Performed by

Checked

1 2 3 4 5 6 7 8

A

B

C

D

E

F

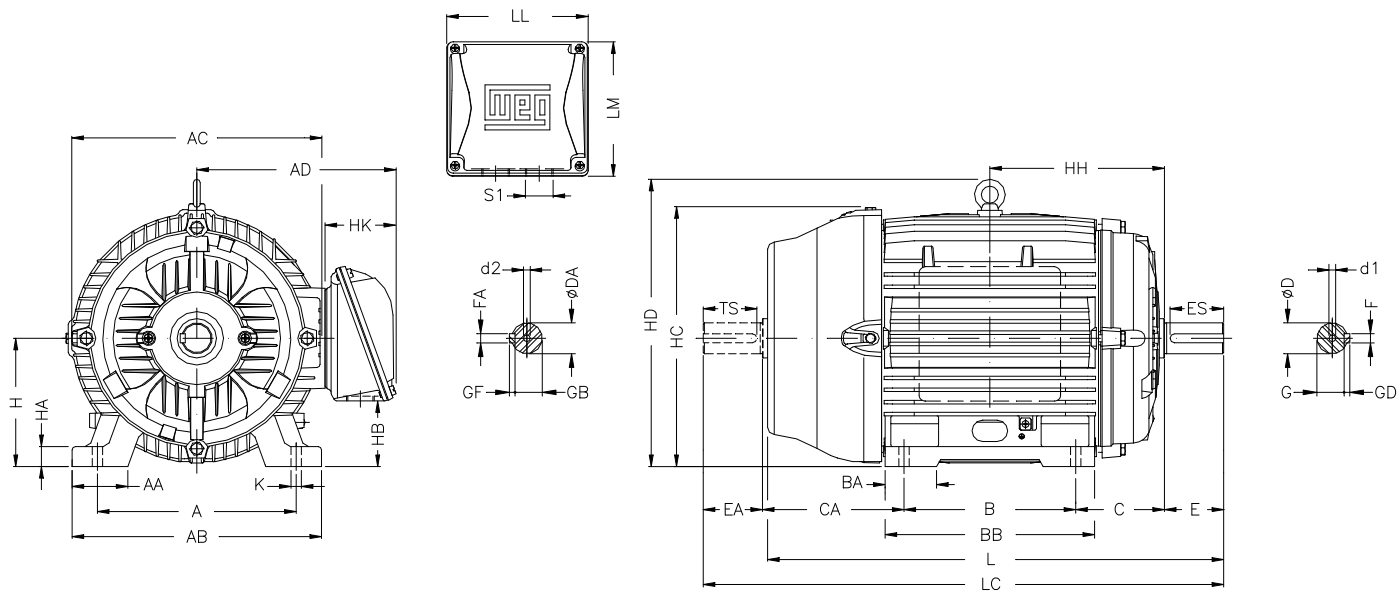

Notes: Downloaded from <http://dealerselectric.com>
Generated for Model #01818ET3Y180M-W22

A 279	AA 78	AB 350	AC 360	AD 281
B 241	BA 70	BB 294	C 121	CA 200
D 48k6	E 110	ES 80	F 14	G 42.5
GD 9	DA 48k6	EA 110	TS 80	FA 14
GB 42.5	GF 9	H 180	HA 28	HC 366
HD 413	K 14.5	L 664	LC 782	S1 2xM40x1,5
d1 DM16	d2 DM16			

Performed by:	
Checked:	
Customer:	
Three-Phase: W22 IE3 IEC Tru-Metric - TEFC (IP55) Cast Iron Frame	
Three-phase induction motor Frame 180M - IP55	23-SEP-2016



LOW VOLTAGE

HIGH VOLTAGE

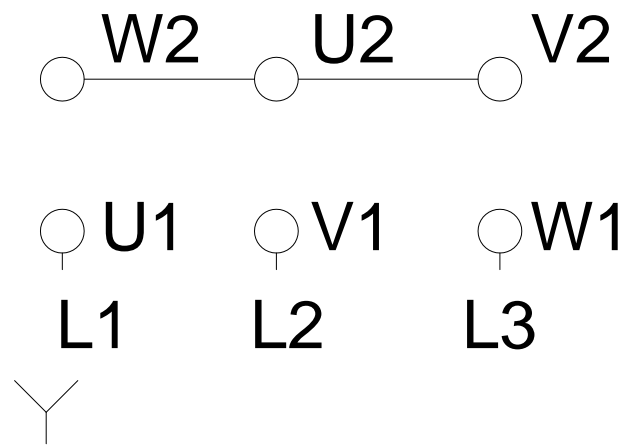
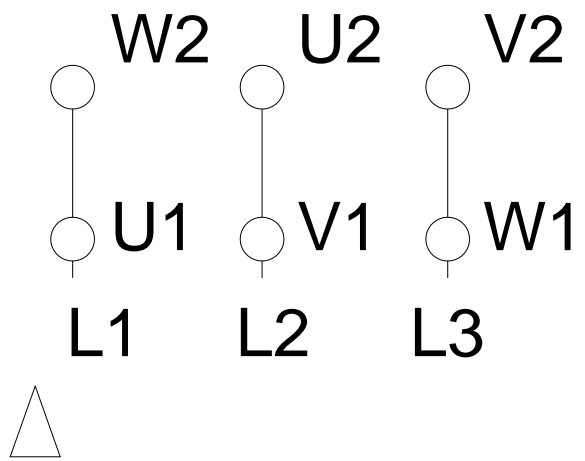

Notes: Downloaded from <http://dealerselectric.com>
Generated for Model #01818ET3Y180M-W22

Performed by:

Checked:

Customer:

Three-Phase: W22 IE3 IEC Tru-Metric - TEFC (IP55) Cast Iron Frame

Three-phase induction motor
Frame 180M - IP55

23-SEP-2016

