



Dealers Industrial Equipment

No.:

Date: 23-SEP-2016

Customer :

TECHNICAL PROPOSAL

Three-phase induction motor - Squirrel cage rotor

Product line : Three Phase: W01 (Rolled Steel) - ODP - NEMA Premium Efficiency

Catalog Number : 01536OT3E215TC-S

List Price : \$1,543

Notes:

Downloaded from <http://dealerselectric.com>

Generated for Model #01536OT3E215TC-S

Performed by:

Checked:



Dealers Industrial Equipment

No.:

Date: 23-SEP-2016

DATA SHEET Three-phase induction motor - Squirrel cage rotor

Customer :
 Product line : Three Phase: W01 (Rolled Steel) - ODP - NEMA Premium Efficiency

Frame : 213/5T
 Output : 15 HP
 Frequency : 60 Hz
 Poles : 2
 Full load speed : 3535 rpm
 Slip : 1.81 %
 Voltage : 208-230/460 V
 Rated current : 38.0-34.4/17.2 A
 Locked rotor current : 237/119 A
 Locked rotor current (I_L/I_n) : 6.9
 No-load current : 12.3/6.17 A
 Full load torque : 22.0 lb.ft
 Locked rotor torque : 210 %
 Breakdown torque : 280 %
 Design : B
 Insulation class : F
 Temperature rise : 80 K
 Locked rotor time : 8 s (hot)
 Service factor : 1.15
 Duty cycle : S1
 Ambient temperature : -20°C - +40°C
 Altitude : 1000 m
 Degree of Protection : ODP
 Approximate weight : 131 lb
 Moment of inertia : 0.55125 sq.ft.lb
 Noise level : 66 dB(A)

	D.E.	N.D.E.
Bearings	6208 ZZ	6206 ZZ
Regreasing interval	---	---
Grease amount	---	---

Load	Power factor	Efficiency (%)
100%	0.89	90.2
75%	0.86	90.2
50%	0.77	90.2

Notes:
 Downloaded from <http://dealerselectric.com>
 Generated for Model #01536OT3E215TC-S

Performed by

Checked



Dealers Industrial Equipment

No.:

Date: 23-SEP-2016

PERFORMANCE CURVES RELATED TO RATED OUTPUT

Three-phase induction motor - Squirrel cage rotor

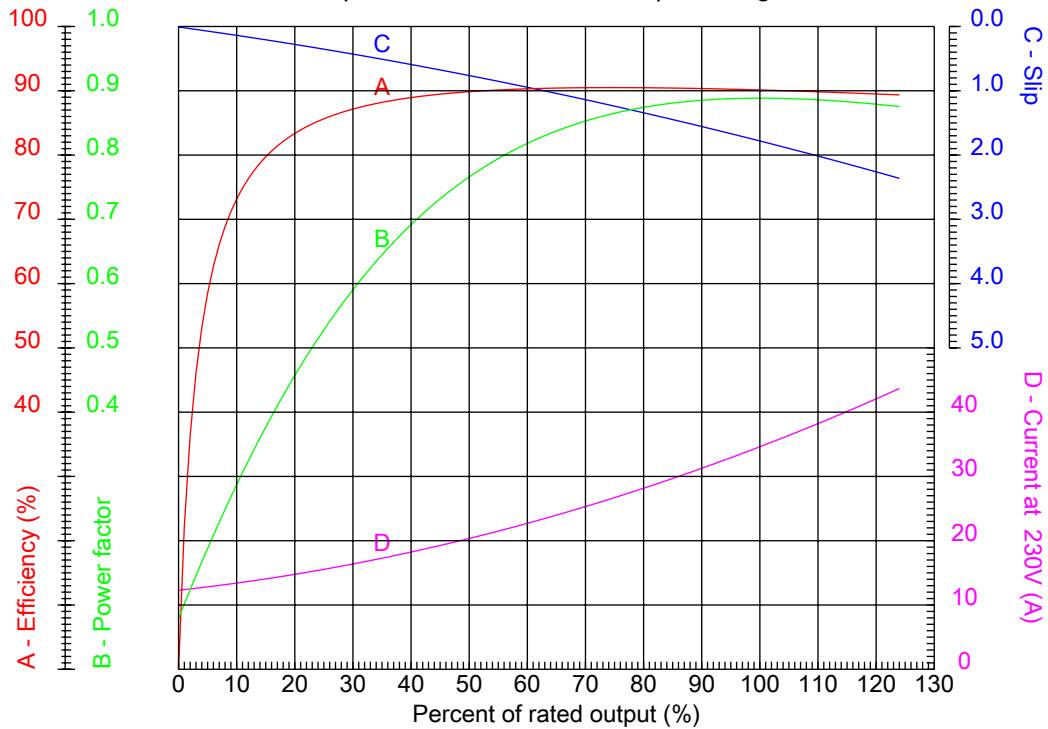

Customer :
Product line : Three Phase: W01 (Rolled Steel) - ODP - NEMA Premium Efficiency

Frame	: 213/5T	Locked rotor current (I _l /I _n)	: 6.9
Output	: 15 HP	Duty cycle	: S1
Frequency	: 60 Hz	Service factor	: 1.15
Full load speed	: 3535 rpm	Design	: B
Voltage	: 208-230/460 V	Locked rotor torque	: 210 %
Rated current	: 38.0-34.4/17.2 A	Breakdown torque	: 280 %
Insulation class	: F		

Notes:
Downloaded from <http://dealerselectric.com>
Generated for Model #01536OT3E215TC-S

Performed by

Checked



Dealers Industrial Equipment

No.:

Date: 23-SEP-2016

CHARACTERISTIC CURVES RELATED TO SPEED

Three-phase induction motor - Squirrel cage rotor

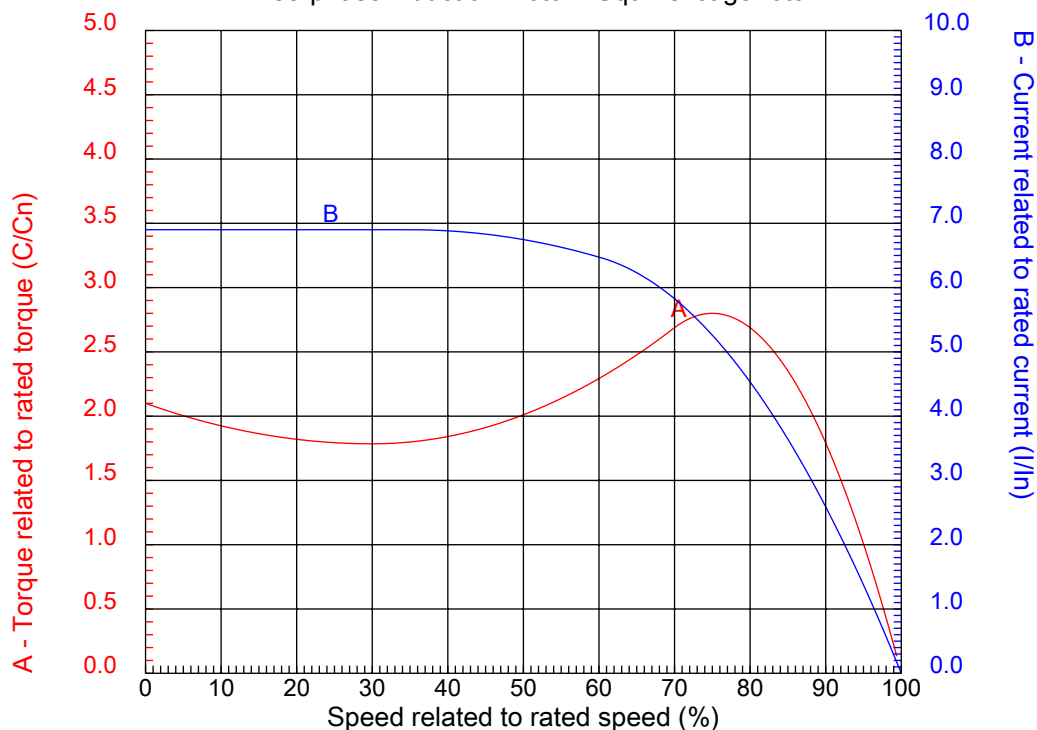

Customer :
Product line : Three Phase: W01 (Rolled Steel) - ODP - NEMA Premium Efficiency

Frame	: 213/5T	Locked rotor current (I _l /I _n)	: 6.9
Output	: 15 HP	Duty cycle	: S1
Frequency	: 60 Hz	Service factor	: 1.15
Full load speed	: 3535 rpm	Design	: B
Voltage	: 208-230/460 V	Locked rotor torque	: 210 %
Rated current	: 38.0-34.4/17.2 A	Breakdown torque	: 280 %
Insulation class	: F		

Notes:
Downloaded from <http://dealerselectric.com>
Generated for Model #01536OT3E215TC-S

Performed by

Checked

1 2 3 4 5 6 7 8

A

B

C

D

E

F

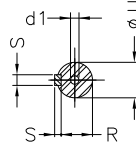
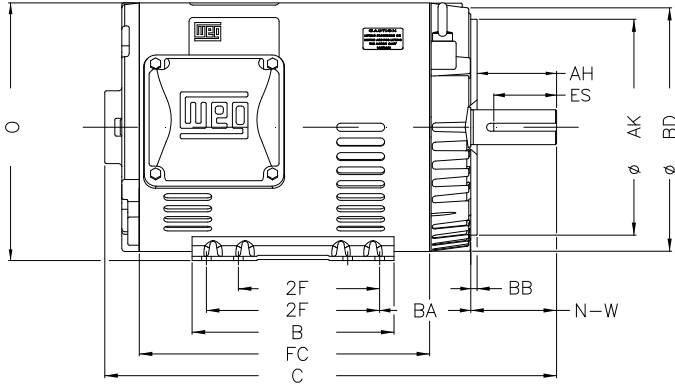
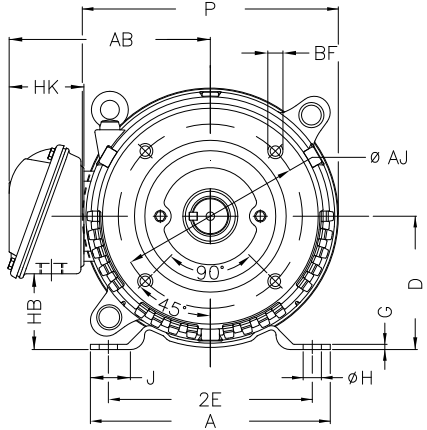
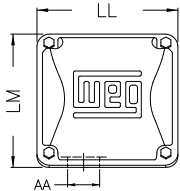

Notes: Downloaded from <http://dealerselectric.com>
Generated for Model #01536OT3E215TC-S

P	AB	J	2E	A
9.846	7.973	1.575	8.500	9.449
H	G	HB	HK	T
0.406	0.167	2.982	3.022	0.029
O	FC	2F	B	C
10.144	11.417	5.500/7.000	7.953	17.756
BA	N-W	ES	d1	S
4.250	3.380	2.480	A 4	0.313
U	AA	depth	R	LL
1.375	1.377"	0.313	1.203	5.551
LM	D	CH	Flange	AJ
5.250	5.250	1.929	FC-184	7.250
AK	BD	BF	BB	AH
8.500	9.401	UNC 1/2"x13	0.250	3.129

Performed by:	Three Phase: W01 (Rolled Steel) - ODP - NEMA Premium Efficiency Three-phase induction motor Frame 213/5T - ODP	23-SEP-2016	
Checked:			
Customer:			

1 2 3 4 5 6 7 8

LOW VOLTAGE

HIGH VOLTAGE

A
B
C
D
E
F

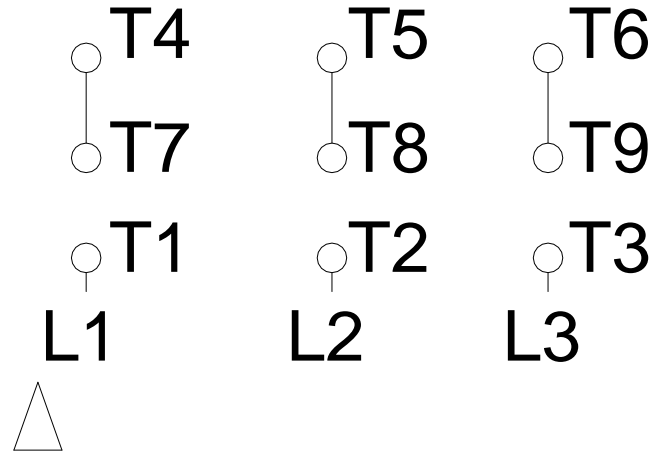

Notes: Downloaded from <http://dealerselectric.com>
 Generated for Model #01536OT3E215TC-S

Performed by:

Checked:

Customer:

Three Phase: W01 (Rolled Steel) - ODP - NEMA Premium Efficiency

Three-phase induction motor
 Frame 213/5T - IP21

23-SEP-2016

