



# Dealers Industrial Equipment

No.:

Date: 23-SEP-2016

Customer :

## TECHNICAL PROPOSAL

### Three-phase induction motor - Squirrel cage rotor

Product line : W22 NEMA Premium - Ball Bearings

Catalog Number : 01536ET3E254TC-W22

List Price : \$1,893

#### Notes:

Downloaded from <http://dealerselectric.com>

Generated for Model #01536ET3E254TC-W22

Performed by:

Checked:



# Dealers Industrial Equipment

No.:

Date: 23-SEP-2016

## DATA SHEET Three-phase induction motor - Squirrel cage rotor

Customer :  
Product line : W22 NEMA Premium - Ball Bearings

Frame : 254/6T  
Output : 15 HP  
Frequency : 60 Hz  
Poles : 2  
Full load speed : 3530 rpm  
Slip : 1.94 %  
Voltage : 208-230/460 V  
Rated current : 38.0-34.4/17.2 A  
Locked rotor current : 230/115 A  
Locked rotor current (I<sub>L</sub>/I<sub>n</sub>) : 6.7  
No-load current : 12.0/6.00 A  
Full load torque : 22.0 lb.ft  
Locked rotor torque : 220 %  
Breakdown torque : 270 %  
Design : B  
Insulation class : F  
Temperature rise : 80 K  
Locked rotor time : 25 s (hot)  
Service factor : 1.25  
Duty cycle : S1  
Ambient temperature : -20°C - +40°C  
Altitude : 1000 m  
Degree of Protection : IP55  
Approximate weight : 236 lb  
Moment of inertia : 1.2565 sq.ft.lb  
Noise level : 72 dB(A)

	D.E.	N.D.E.
Bearings	6309 C3	6209 C3
Regreasing interval	19000 h	20000 h
Grease amount	13 g	9 g

Load	Power factor	Efficiency (%)
100%	0.88	91.0
75%	0.85	91.0
50%	0.77	89.5

Notes:  
Downloaded from <http://dealerselectric.com>  
Generated for Model #01536ET3E254TC-W22

Performed by

Checked



# Dealers Industrial Equipment

No.:

Date: 23-SEP-2016

## PERFORMANCE CURVES RELATED TO RATED OUTPUT

Three-phase induction motor - Squirrel cage rotor

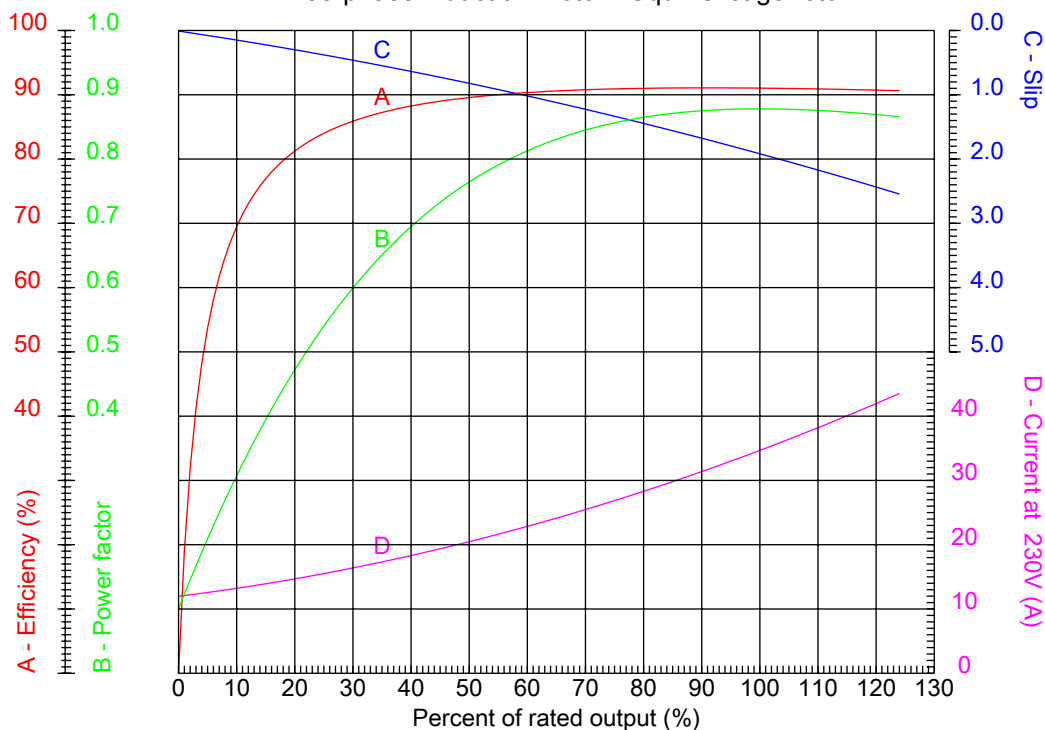

Customer :  
Product line : W22 NEMA Premium - Ball Bearings

Frame	: 254/6T	Locked rotor current (I <sub>l</sub> /I <sub>n</sub> )	: 6.7
Output	: 15 HP	Duty cycle	: S1
Frequency	: 60 Hz	Service factor	: 1.25
Full load speed	: 3530 rpm	Design	: B
Voltage	: 208-230/460 V	Locked rotor torque	: 220 %
Rated current	: 38.0-34.4/17.2 A	Breakdown torque	: 270 %
Insulation class	: F		

Notes:  
Downloaded from <http://dealerselectric.com>  
Generated for Model #01536ET3E254TC-W22

Performed by

Checked



# Dealers Industrial Equipment

No.:

Date: 23-SEP-2016

## CHARACTERISTIC CURVES RELATED TO SPEED

Three-phase induction motor - Squirrel cage rotor

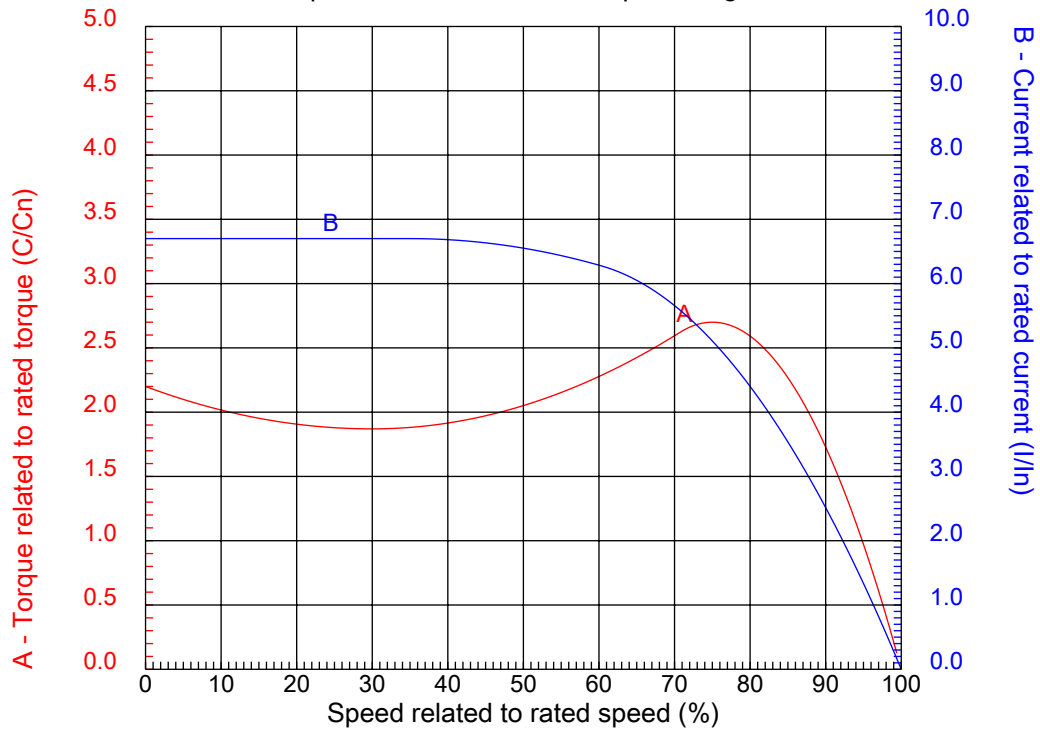

Customer :  
Product line : W22 NEMA Premium - Ball Bearings

Frame	: 254/6T	Locked rotor current (I <sub>l</sub> /I <sub>n</sub> )	: 6.7
Output	: 15 HP	Duty cycle	: S1
Frequency	: 60 Hz	Service factor	: 1.25
Full load speed	: 3530 rpm	Design	: B
Voltage	: 208-230/460 V	Locked rotor torque	: 220 %
Rated current	: 38.0-34.4/17.2 A	Breakdown torque	: 270 %
Insulation class	: F		

Notes:  
Downloaded from <http://dealerselectric.com>  
Generated for Model #01536ET3E254TC-W22

Performed by

Checked

1 2 3 4 5 6 7 8

A

B

C

D

E

F

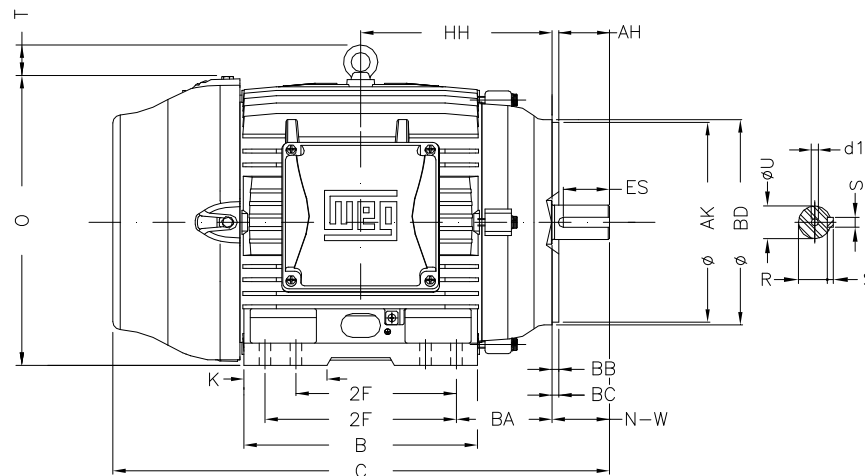
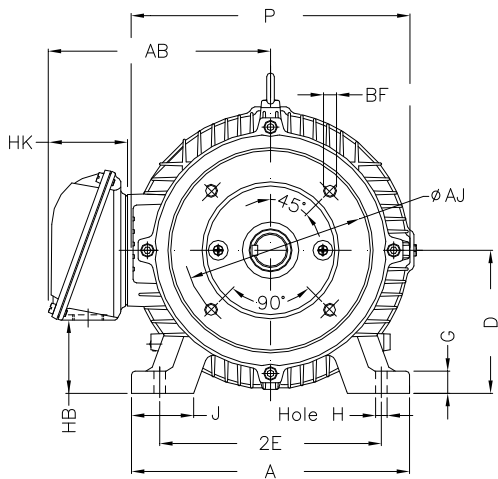
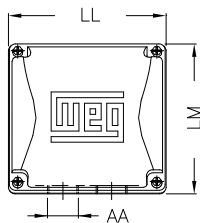

Notes: Downloaded from <http://dealerselectric.com>  
Generated for Model #01536ET3E254TC-W22

Performed by:

Checked:

Customer:

W22 NEMA Premium - Ball Bearings

Three-phase induction motor  
Frame 254/6T - IP55

23-SEP-2016



2E	J	A	P	AB
10.000	2.539	12.126	12.953	10.483
2F	K	B	BA	FBA
8.252/10.000	2.559	11.732	4.250	6.852
U	N-W	ES	S	R
1.625	4.000	2.756	0.375	1.416
depth	D	G	HB	O
0.375	6.250	0.827	3.061	12.598
T	HF	HH	HK	H
2.087	6.565	9.250	3.976	0.531
C	LL	LM	AA	d1
24.945	7.815	7.480	NPT 1 1/2"	A 4
Flange	AJ	AK	BD	BF
FC-184	7.250	8.500	8.875	UNC 1/2"x13
BB	BC	AH		
0.250	0.250	3.750		

1 2 3 4 5 6 7 8

A  
B  
C  
D  
E  
F

LOW VOLTAGE

HIGH VOLTAGE



CONNECTIONS FOR STARTING ONLY:

LOW VOLTAGE

HIGH VOLTAGE



Notes: Downloaded from <http://dealerselectric.com>  
Generated for Model #01536ET3E254TC-W22

Performed by:

Checked:

Customer:

W22 NEMA Premium - Ball Bearings

Three-phase induction motor  
Frame 254/6T - IP55

23-SEP-2016

