



Dealers Industrial Equipment

No.:

Date: 23-SEP-2016

Customer :

TECHNICAL PROPOSAL

Three-phase induction motor - Squirrel cage rotor

Product line : W22 High Efficiency

Catalog Number : 01536EP3ER254TC-W22

List Price : \$1,707

Notes:

Downloaded from <http://dealerselectric.com>

Generated for Model #01536EP3ER254TC-W22

Performed by:

Checked:



Dealers Industrial Equipment

No.:

Date: 23-SEP-2016

DATA SHEET Three-phase induction motor - Squirrel cage rotor

Customer :
Product line : W22 High Efficiency

Frame : 254T
Output : 15 HP
Frequency : 60 Hz
Poles : 2
Full load speed : 3520 rpm
Slip : 2.22 %
Voltage : 230/460 V
Rated current : 34.8/17.4 A
Locked rotor current : 216/108 A
Locked rotor current (I_L/I_n) : 6.2
No-load current : 11.0/5.50 A
Full load torque : 22.1 lb.ft
Locked rotor torque : 200 %
Breakdown torque : 250 %
Design : B
Insulation class : F
Temperature rise : 80 K
Locked rotor time : 18 s (hot)
Service factor : 1.25
Duty cycle : S1
Ambient temperature : -20°C - +40°C
Altitude : 1000 m
Degree of Protection : IP55
Approximate weight : 225 lb
Moment of inertia : 1.2565 sq.ft.lb
Noise level : 72 dB(A)

	D.E.	N.D.E.
Bearings	6309 C3	6209 C3
Regreasing interval	19000 h	20000 h
Grease amount	13 g	9 g

Load	Power factor	Efficiency (%)
100%	0.88	90.2
75%	0.86	90.2
50%	0.78	89.5

Notes:

Downloaded from <http://dealerselectric.com>
Generated for Model #01536EP3ER254TC-W22

Performed by

Checked



Dealers Industrial Equipment

No.:

Date: 23-SEP-2016

PERFORMANCE CURVES RELATED TO RATED OUTPUT

Three-phase induction motor - Squirrel cage rotor

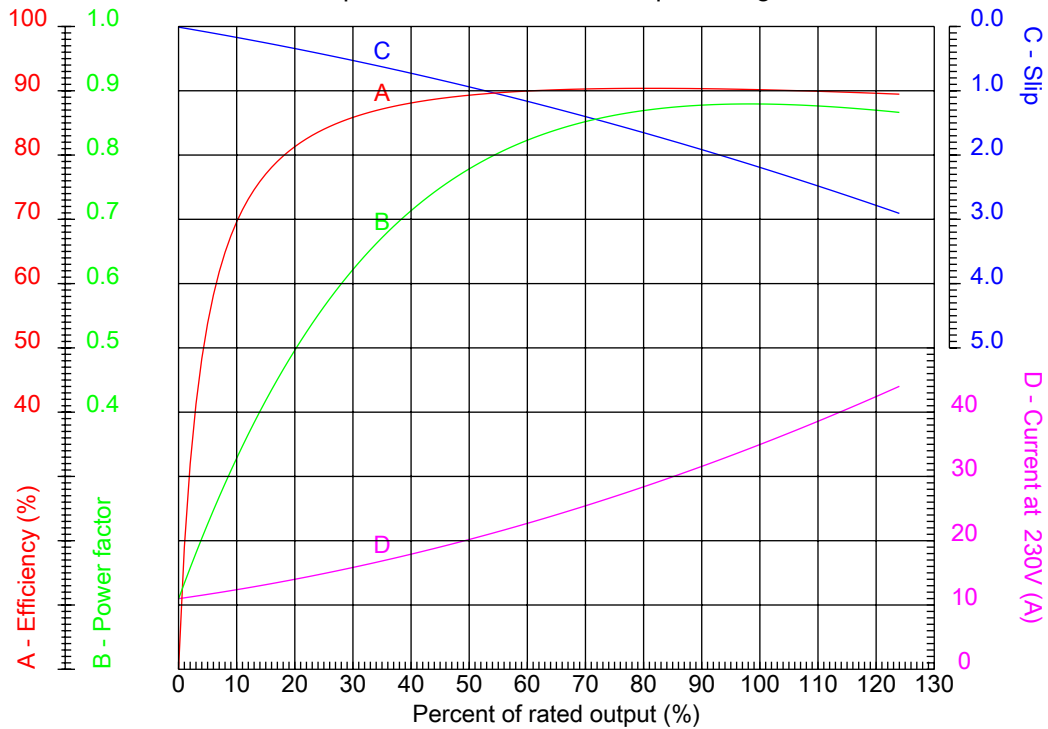

Customer :
Product line : W22 High Efficiency

Frame : 254T	Locked rotor current (I _l /I _n) : 6.2
Output : 15 HP	Duty cycle : S1
Frequency : 60 Hz	Service factor : 1.25
Full load speed : 3520 rpm	Design : B
Voltage : 230/460 V	Locked rotor torque : 200 %
Rated current : 34.8/17.4 A	Breakdown torque : 250 %
Insulation class : F	

Notes:
Downloaded from <http://dealerselectric.com>
Generated for Model #01536EP3ER254TC-W22

Performed by

Checked



Dealers Industrial Equipment

No.:

Date: 23-SEP-2016

CHARACTERISTIC CURVES RELATED TO SPEED

Three-phase induction motor - Squirrel cage rotor

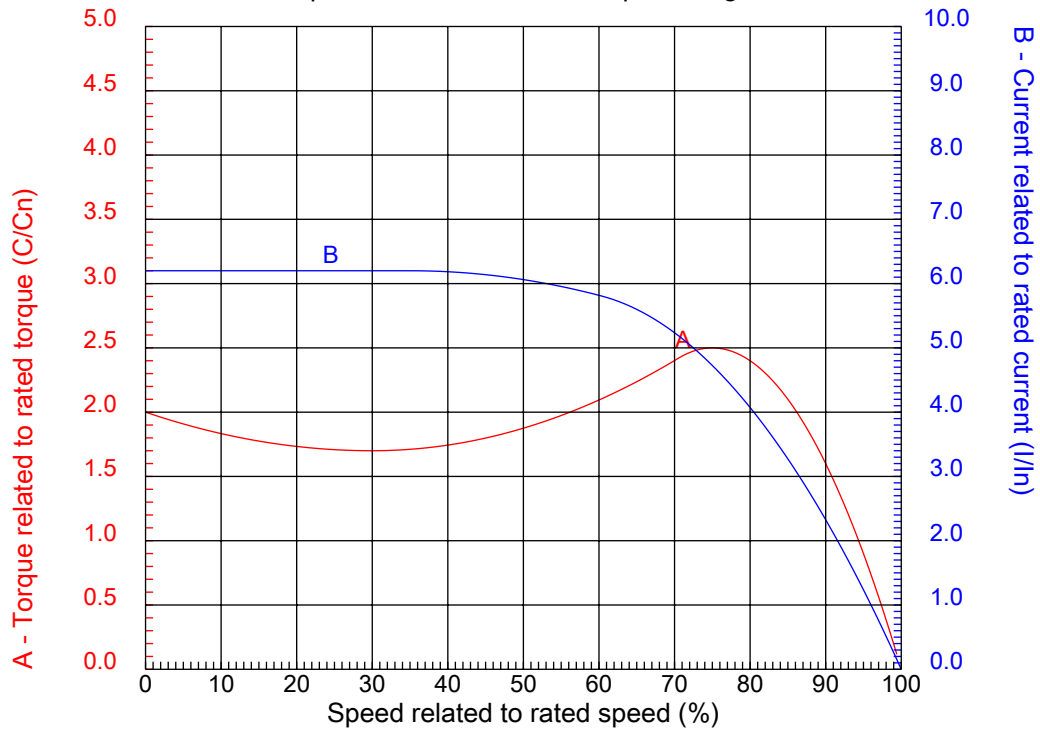

Customer :
Product line : W22 High Efficiency

Frame	: 254T	Locked rotor current (I _l /I _n)	: 6.2
Output	: 15 HP	Duty cycle	: S1
Frequency	: 60 Hz	Service factor	: 1.25
Full load speed	: 3520 rpm	Design	: B
Voltage	: 230/460 V	Locked rotor torque	: 200 %
Rated current	: 34.8/17.4 A	Breakdown torque	: 250 %
Insulation class	: F		

Notes:
Downloaded from <http://dealerselectric.com>
Generated for Model #01536EP3ER254TC-W22

Performed by

Checked

1 2 3 4 5 6 7 8

A
B
C
D
E
F

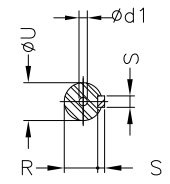
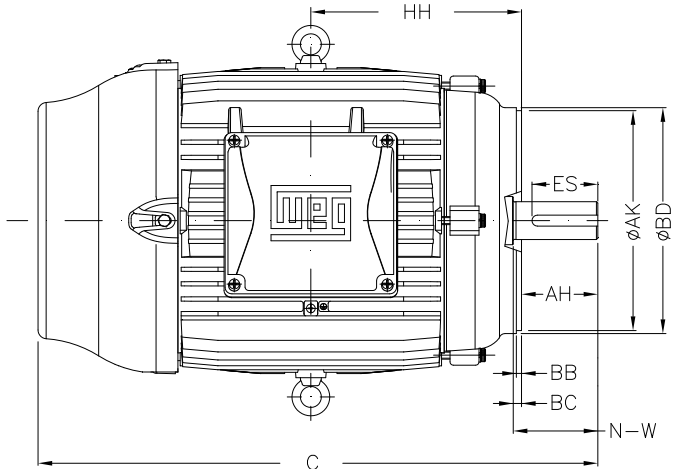
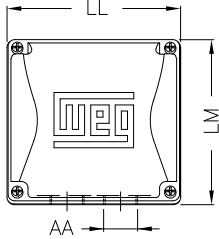
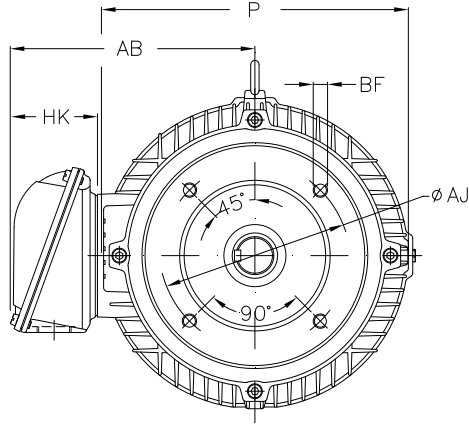

Notes: Downloaded from <http://dealerselectric.com>
Generated for Model #01536EP3ER254TC-W22

Performed by:

Checked:

Customer:

W22 High Efficiency

P	AB	U	N-W	ES
12.953	10.483	1.625	4.000	2.756
S	R	depth	HH	HK
0.375	1.416	0.375	8.376	3.976
C	LL	LM	AA	d1
23.213	7.815	7.480	NPT 1 1/2"	A 4
Flange	AJ	AK	BD	BF
FC-184	7.250	8.500	8.875	UNC 1/2"x13
BB	BC	AH		
0.250	0.250	3.750		

Three-phase induction motor
Frame 254T - IP55

23-SEP-2016



1 2 3 4 5 6 7 8

A
B
C
D
E
F

LOW VOLTAGE

HIGH VOLTAGE



CONNECTIONS FOR STARTING ONLY:

LOW VOLTAGE

HIGH VOLTAGE



Notes: Downloaded from <http://dealerselectric.com>
Generated for Model #01536EP3ER254TC-W22

Performed by:

Checked:

Customer:

W22 High Efficiency

Three-phase induction motor
Frame 254T - IP55

23-SEP-2016

