



Dealers Industrial Equipment

No.:

Date: 23-SEP-2016

Customer :

TECHNICAL PROPOSAL

Three-phase induction motor - Squirrel cage rotor

Product line : Three-Phase : Explosion Proof - NEMA Premium

Catalog Number : 01518XT3H254T

List Price : \$2,653

Notes:

Downloaded from <http://dealerselectric.com>

Generated for Model #01518XT3H254T

Performed by:

Checked:



# Dealers Industrial Equipment

No.:

Date: 23-SEP-2016

## DATA SHEET Three-phase induction motor - Squirrel cage rotor

Customer :  
 Product line : Three-Phase : Explosion Proof - NEMA Premium

Frame : 254T  
 Output : 15 HP  
 Frequency : 60 Hz  
 Poles : 4  
 Full load speed : 1770 rpm  
 Slip : 1.67 %  
 Voltage : 575 V  
 Rated current : 14.7 A  
 Locked rotor current : 107 A  
 Locked rotor current (I<sub>L</sub>/I<sub>n</sub>) : 7.3  
 No-load current : 6.88 A  
 Full load torque : 43.9 lb.ft  
 Locked rotor torque : 300 %  
 Breakdown torque : 300 %  
 Design : B  
 Insulation class : F  
 Temperature rise : 80 K  
 Locked rotor time : 26 s (hot)  
 Service factor : 1.15  
 Duty cycle : S1  
 Ambient temperature : -20°C - +40°C  
 Altitude : 1000 m  
 Degree of Protection : IP55  
 Approximate weight : 329 lb  
 Moment of inertia : 2.3111 sq.ft.lb  
 Noise level : 69 dB(A)

	D.E.	N.D.E.
Bearings	6309 2RS-C3	6209 2RS-C3
Regreasing interval	---	---
Grease amount	---	---

Load	Power factor	Efficiency (%)
100%	0.81	92.4
75%	0.75	91.7
50%	0.65	90.2

Notes:  
 Downloaded from <http://dealerselectric.com>  
 Generated for Model #01518XT3H254T

Performed by

Checked



# Dealers Industrial Equipment

No.:

Date: 23-SEP-2016

## PERFORMANCE CURVES RELATED TO RATED OUTPUT

Three-phase induction motor - Squirrel cage rotor

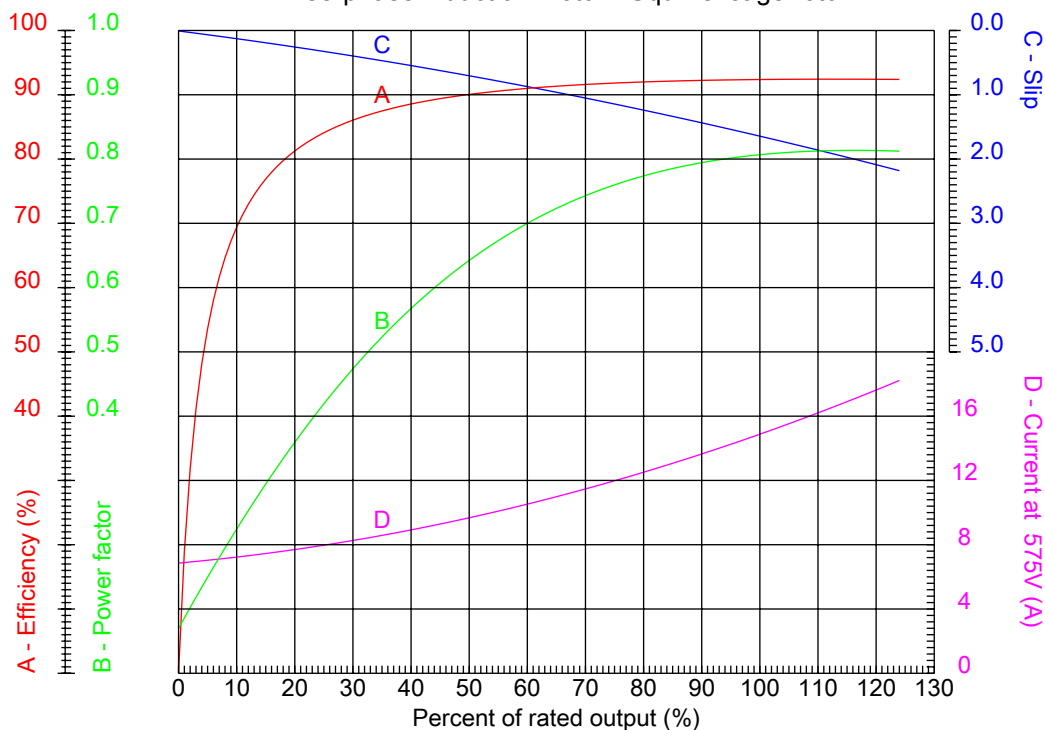

Customer :  
Product line : Three-Phase : Explosion Proof - NEMA Premium

Frame	: 254T	Locked rotor current (I <sub>l</sub> /I <sub>n</sub> )	: 7.3
Output	: 15 HP	Duty cycle	: S1
Frequency	: 60 Hz	Service factor	: 1.15
Full load speed	: 1770 rpm	Design	: B
Voltage	: 575 V	Locked rotor torque	: 300 %
Rated current	: 14.7 A	Breakdown torque	: 300 %
Insulation class	: F		

Notes:  
Downloaded from <http://dealerselectric.com>  
Generated for Model #01518XT3H254T

Performed by

Checked



# Dealers Industrial Equipment

No.:

Date: 23-SEP-2016

## CHARACTERISTIC CURVES RELATED TO SPEED

Three-phase induction motor - Squirrel cage rotor

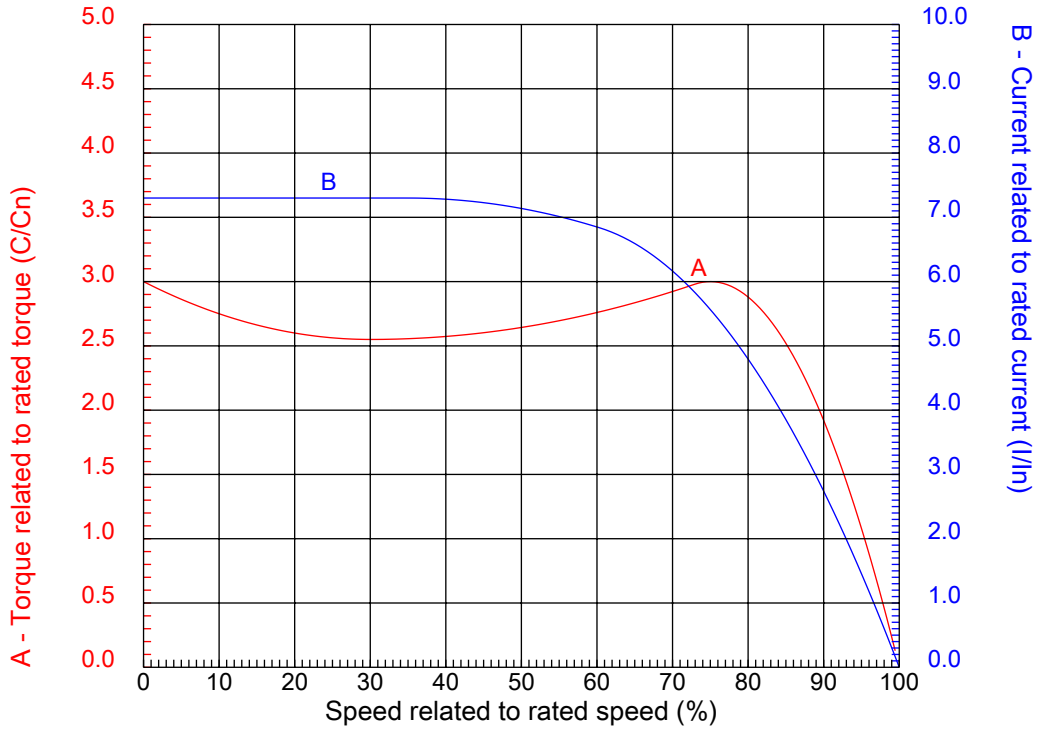

Customer :  
Product line : Three-Phase : Explosion Proof - NEMA Premium

Frame	: 254T	Locked rotor current (I <sub>l</sub> /I <sub>n</sub> )	: 7.3
Output	: 15 HP	Duty cycle	: S1
Frequency	: 60 Hz	Service factor	: 1.15
Full load speed	: 1770 rpm	Design	: B
Voltage	: 575 V	Locked rotor torque	: 300 %
Rated current	: 14.7 A	Breakdown torque	: 300 %
Insulation class	: F		

Notes:  
Downloaded from <http://dealerselectric.com>  
Generated for Model #01518XT3H254T

Performed by

Checked

1 2 3 4 5 6 7 8

A

B

C

D

E

F

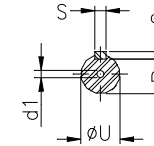

Notes: Downloaded from <http://dealerselectric.com>  
Generated for Model #01518XT3H254T

Performed by:

Checked:

Customer:

Three-Phase : Explosion Proof - NEMA Premium

Three-phase induction motor  
Frame 254T - IP55

23-SEP-2016



2E 10.000	A 12.126	2F 8.252	B 10.000	BA 4.250
J 2.520	K 2.559	P 12.224	ES 2.756	depth 0.375
S 0.375	N-W 4.000	U 1.625	R 1.416	AB 11.063
D 6.250	G 0.817	O 12.352	T 2.087	H 0.531
C 23.175	AA NPT 1 1/2"	d1 A 4	d2 A 4	

1 2 3 4 5 6 7 8

A  
B  
C  
D  
E  
F

### RUN

### ONLY FOR START

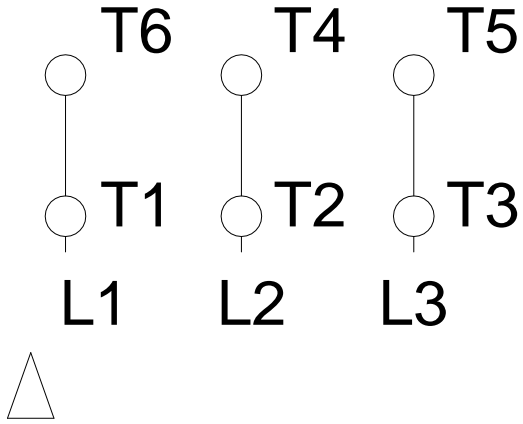

Notes: Downloaded from <a href="http://dealerselectric.com">http://dealerselectric.com</a> Generated for Model #01518XT3H254T		
Performed by:		
Checked:		
Customer:		
Three-Phase : Explosion Proof - NEMA Premium		
Three-phase induction motor Frame 254T - IP55	23-SEP-2016	