



Dealers Industrial Equipment

No.:

Date: 23-SEP-2016

Customer :

TECHNICAL PROPOSAL

Three-phase induction motor - Squirrel cage rotor

Product line : Close Coupled Pump: Three-Phase - W22 "JP" Type - TEFC - NEMA Premium

Catalog Number : 01518ET3E254JP-W22

List Price : \$2,653

Notes:

Downloaded from <http://dealerselectric.com>

Generated for Model #01518ET3E254JP-W22

Performed by:

Checked:



Dealers Industrial Equipment

No.:

Date: 23-SEP-2016

DATA SHEET Three-phase induction motor - Squirrel cage rotor

Customer :
 Product line : Close Coupled Pump: Three-Phase - W22 "JP" Type - TEFC - NEMA Premium

Frame : 254/6JP
 Output : 15 HP
 Frequency : 60 Hz
 Poles : 4
 Full load speed : 1765 rpm
 Slip : 1.94 %
 Voltage : 208-230/460 V
 Rated current : 39.8-36.0/18.0 A
 Locked rotor current : 230/115 A
 Locked rotor current (I_L/I_n) : 6.4
 No-load current : 16.0/8.00 A
 Full load torque : 44.0 lb.ft
 Locked rotor torque : 230 %
 Breakdown torque : 270 %
 Design : B
 Insulation class : F
 Temperature rise : 80 K
 Locked rotor time : 17 s (hot)
 Service factor : 1.25
 Duty cycle : S1
 Ambient temperature : -20°C - +40°C
 Altitude : 1000 m
 Degree of Protection : IP55
 Approximate weight : 251 lb
 Moment of inertia : 2.6198 sq.ft.lb
 Noise level : 64 dB(A)

	D.E.	N.D.E.
Bearings	6309 C3	6209 C3
Regreasing interval	20000 h	20000 h
Grease amount	13 g	9 g

Load	Power factor	Efficiency (%)
100%	0.83	92.4
75%	0.78	91.7
50%	0.68	91.0

Notes:
 Downloaded from <http://dealerselectric.com>
 Generated for Model #01518ET3E254JP-W22

Performed by

Checked



Dealers Industrial Equipment

No.:

Date: 23-SEP-2016

PERFORMANCE CURVES RELATED TO RATED OUTPUT

Three-phase induction motor - Squirrel cage rotor

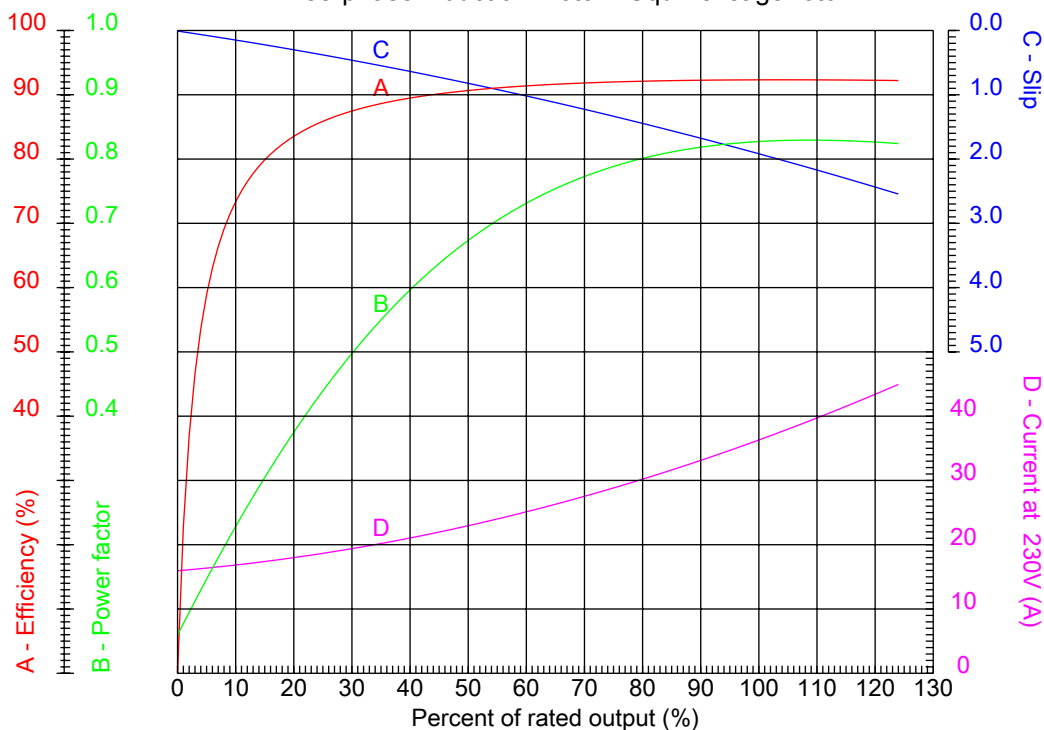

Customer :
 Product line : Close Coupled Pump: Three-Phase - W22 "JP" Type - TEFC - NEMA Premium

Frame	: 254/6JP	Locked rotor current (I _l /I _n)	: 6.4
Output	: 15 HP	Duty cycle	: S1
Frequency	: 60 Hz	Service factor	: 1.25
Full load speed	: 1765 rpm	Design	: B
Voltage	: 208-230/460 V	Locked rotor torque	: 230 %
Rated current	: 39.8-36.0/18.0 A	Breakdown torque	: 270 %
Insulation class	: F		

Notes:
 Downloaded from <http://dealerselectric.com>
 Generated for Model #01518ET3E254JP-W22

Performed by

Checked



Dealers Industrial Equipment

No.:

Date: 23-SEP-2016

CHARACTERISTIC CURVES RELATED TO SPEED

Three-phase induction motor - Squirrel cage rotor

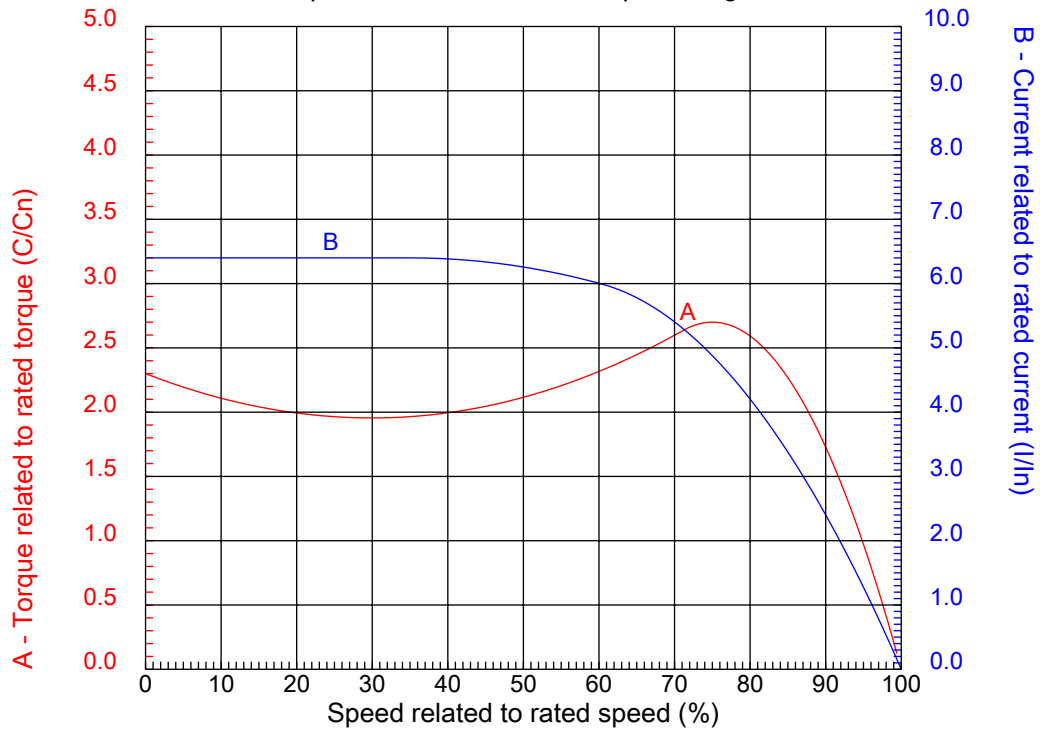

Customer :
Product line : Close Coupled Pump: Three-Phase - W22 "JP" Type - TEFC - NEMA Premium

Frame	: 254/6JP	Locked rotor current (I _l /I _n)	: 6.4
Output	: 15 HP	Duty cycle	: S1
Frequency	: 60 Hz	Service factor	: 1.25
Full load speed	: 1765 rpm	Design	: B
Voltage	: 208-230/460 V	Locked rotor torque	: 230 %
Rated current	: 39.8-36.0/18.0 A	Breakdown torque	: 270 %
Insulation class	: F		

Notes:
Downloaded from <http://dealerselectric.com>
Generated for Model #01518ET3E254JP-W22

Performed by

Checked

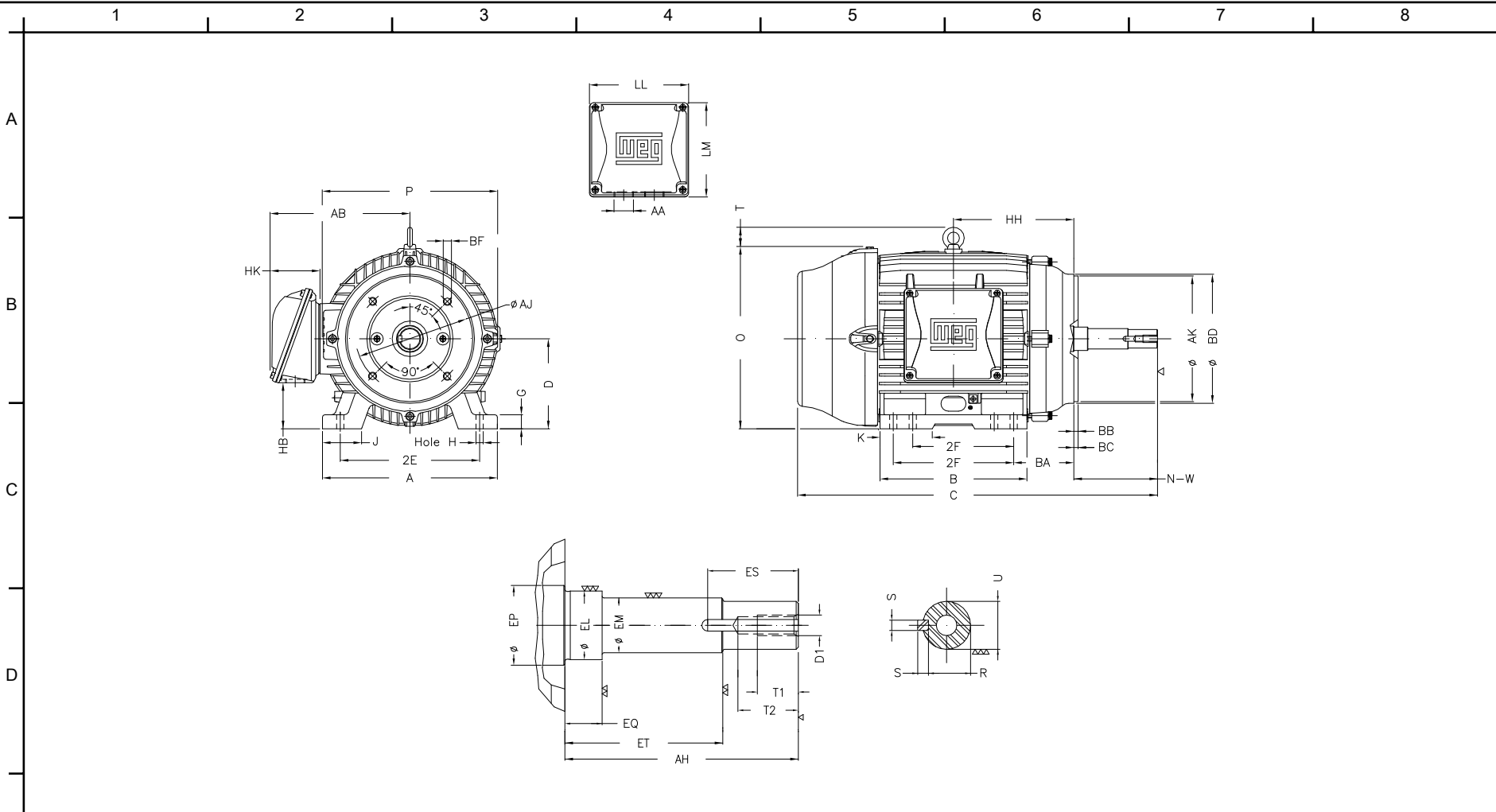

Notes: Downloaded from <http://dealerselectric.com>
 Generated for Model #01518ET3E254JP-W22

2E	J	A	P	AB
10.000	2.539	12.126	12.953	10.483
2F	K	B	BA	D
8.252/10.000	2.559	11.732	4.250	6.250
G	O	T	H	AA
0.827	12.598	2.087	0.531	NPT 1 1/2"
EQ	ET	U	EM	EL
2.382	5.886	1.249	1.375	1.750
EP	ES	t1	t2	C
1.770	2.480	0.984	1.496	29.106
d1	HH	HK	HB	LL
EUNC 1/2"-13	9.250	3.976	3.061	7.815
LM	S	R	Flange	AJ
7.480	0.250	1.110	FC-184	7.252
AK	BD	BF	BB	AH
8.500	8.858	UNC 1/2"x13	0.248	8.130

Performed by:

Checked:

Customer:

Close Coupled Pump: Three-Phase - W22 "JP" Type - TEFC - NEMA Premium

Three-phase induction motor
 Frame 254/6JP - IP55

23-SEP-2016



1 2 3 4 5 6 7 8

A
B
C
D
E
F

LOW VOLTAGE

HIGH VOLTAGE

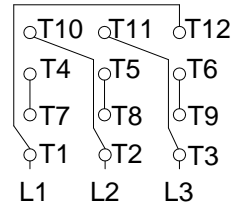
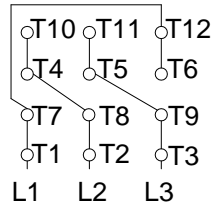

CONNECTIONS FOR STARTING ONLY:

LOW VOLTAGE

HIGH VOLTAGE

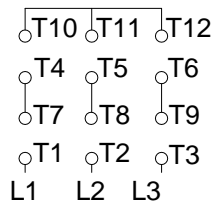
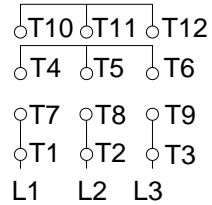

Notes: Downloaded from <http://dealerselectric.com>
Generated for Model #01518ET3E254JP-W22

Performed by:

Checked:

Customer:

Close Coupled Pump: Three-Phase - W22 "JP" Type - TEFC - NEMA Premium

Three-phase induction motor
Frame 254/6JP - IP55

23-SEP-2016

