



Dealers Industrial Equipment

No.:

Date: 23-SEP-2016

Customer :

TECHNICAL PROPOSAL

Three-phase induction motor - Squirrel cage rotor

Product line : Brake Motors : Three-Phase - High Efficiency
Catalog Number : 01518EP3EBM254T
List Price : \$>(discontinued)

Notes:
Downloaded from <http://dealerselectric.com>
Generated for Model #01518EP3EBM254T

Performed by:

Checked:



Dealers Industrial Equipment

No.:

Date: 23-SEP-2016

DATA SHEET

Three-phase induction motor - Squirrel cage rotor

Customer :
 Product line : Brake Motors : Three-Phase - High Efficiency

Frame : 254T
 Output : 15 HP
 Frequency : 60 Hz
 Poles : 4
 Full load speed : 1760 rpm
 Slip : 2.22 %
 Voltage : 230/460 V
 Rated current : 36.2/18.1 A
 Locked rotor current : 232/116 A
 Locked rotor current (I_L/I_n) : 6.4
 No-load current : 15.6/7.80 A
 Full load torque : 44.2 lb.ft
 Locked rotor torque : 250 %
 Breakdown torque : 250 %
 Design : B
 Insulation class : F
 Temperature rise : 80 K
 Locked rotor time : 23 s (hot)
 Service factor : 1.25
 Duty cycle : S1
 Ambient temperature : -20°C - +40°C
 Altitude : 1000 m
 Degree of Protection : IP55
 Approximate weight : 299 lb
 Moment of inertia : 2.1900 sq.ft.lb
 Noise level : 69 dB(A)

| | D.E. | N.D.E. |
|---------------------|---------|-----------|
| Bearings | 6309 C3 | 6209 Z-C3 |
| Regreasing interval | 20000 h | 20000 h |
| Grease amount | 13 g | 9 g |

| Load | Power factor | Efficiency (%) |
|------|--------------|----------------|
| 100% | 0.82 | 91.0 |
| 75% | 0.76 | 91.0 |
| 50% | 0.66 | 90.2 |

Notes:
 Downloaded from <http://dealerselectric.com>
 Generated for Model #01518EP3EBM254T

Performed by

Checked



Dealers Industrial Equipment

No.:

Date: 23-SEP-2016

PERFORMANCE CURVES RELATED TO RATED OUTPUT

Three-phase induction motor - Squirrel cage rotor

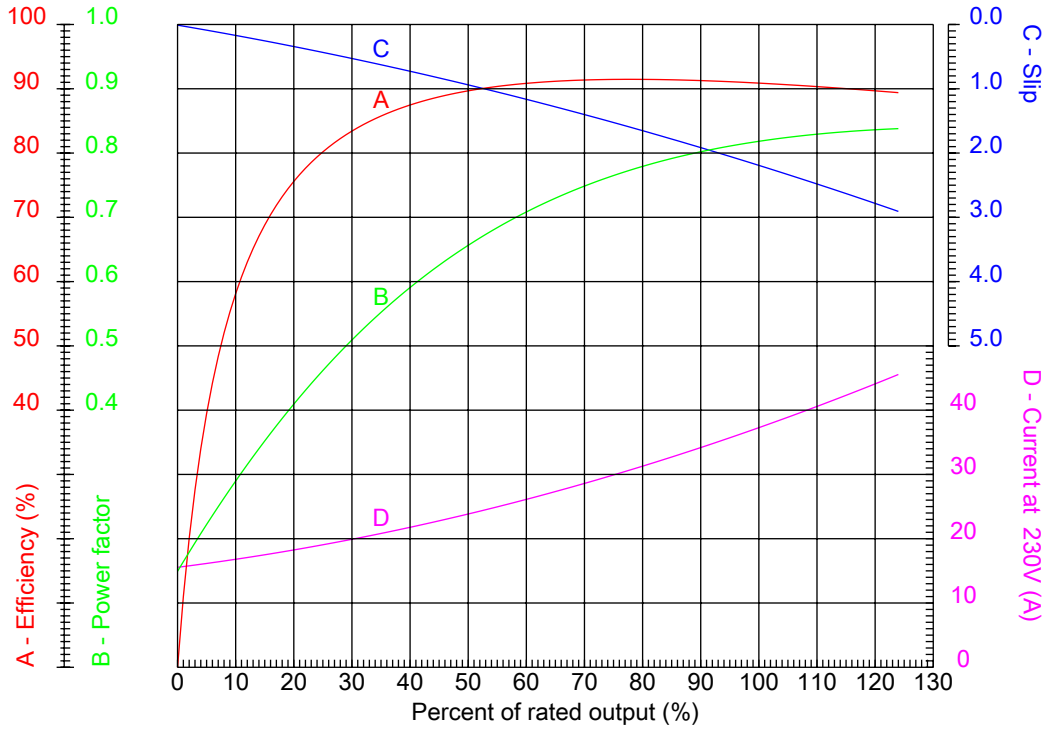

Customer :
 Product line : Brake Motors : Three-Phase - High Efficiency

| | | | |
|------------------|---------------|--|---------|
| Frame | : 254T | Locked rotor current (I _l /I _n) | : 6.4 |
| Output | : 15 HP | Duty cycle | : S1 |
| Frequency | : 60 Hz | Service factor | : 1.25 |
| Full load speed | : 1760 rpm | Design | : B |
| Voltage | : 230/460 V | Locked rotor torque | : 250 % |
| Rated current | : 36.2/18.1 A | Breakdown torque | : 250 % |
| Insulation class | : F | | |

Notes:
 Downloaded from <http://dealerselectric.com>
 Generated for Model #01518EP3EBM254T

Performed by

Checked



Dealers Industrial Equipment

No.:

Date: 23-SEP-2016

CHARACTERISTIC CURVES RELATED TO SPEED

Three-phase induction motor - Squirrel cage rotor

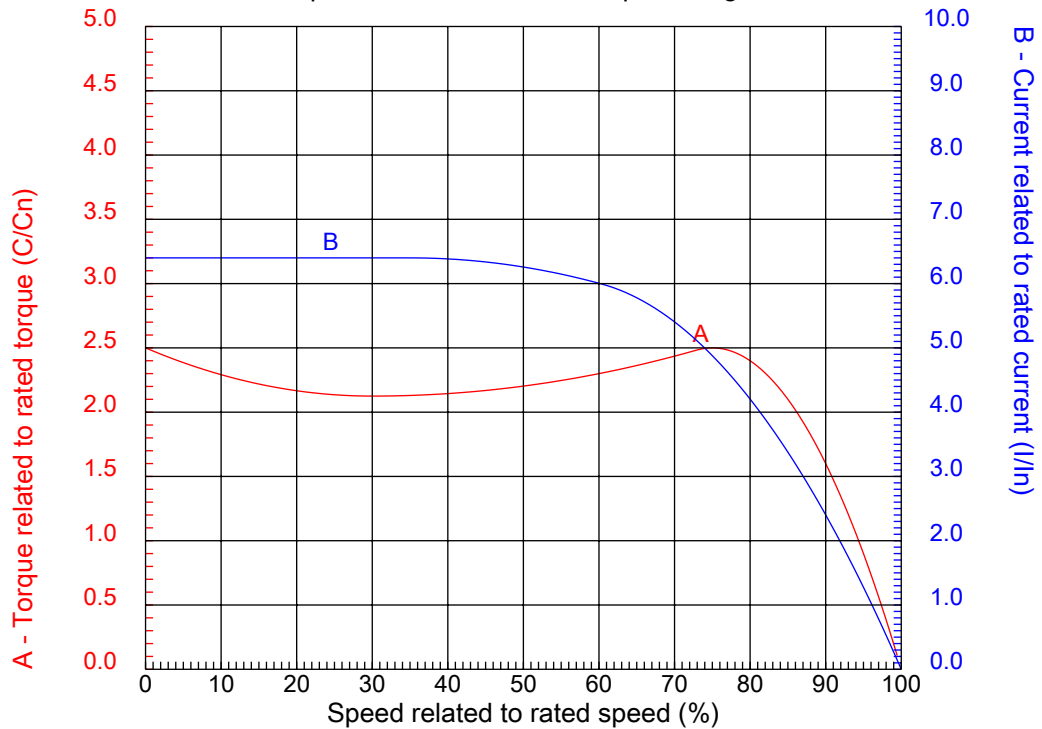

Customer :
Product line : Brake Motors : Three-Phase - High Efficiency

| | | | |
|------------------|---------------|--|---------|
| Frame | : 254T | Locked rotor current (I _l /I _n) | : 6.4 |
| Output | : 15 HP | Duty cycle | : S1 |
| Frequency | : 60 Hz | Service factor | : 1.25 |
| Full load speed | : 1760 rpm | Design | : B |
| Voltage | : 230/460 V | Locked rotor torque | : 250 % |
| Rated current | : 36.2/18.1 A | Breakdown torque | : 250 % |
| Insulation class | : F | | |

Notes:
Downloaded from <http://dealerselectric.com>
Generated for Model #01518EP3EBM254T

Performed by

Checked

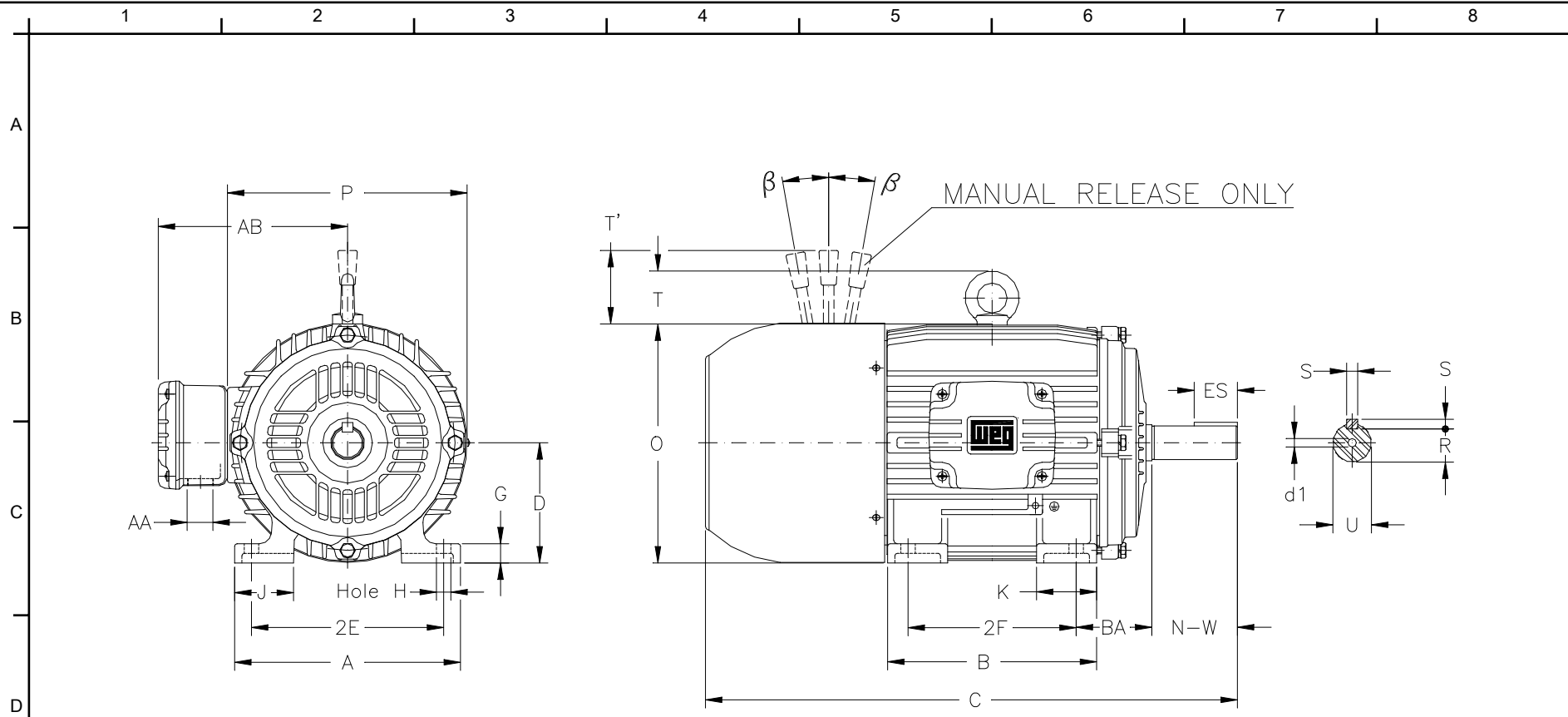

Notes: Downloaded from <http://dealerselectric.com>
 Generated for Model #01518EP3EBM254T

Performed by:

Checked:

Customer:

Brake Motors : Three-Phase - High Efficiency

| | | | | |
|------------------|--------------|-------------|-------------|----------------|
| 2E 10.000 | A 12.126 | 2F 8.252 | B 10.000 | BA 4.250 |
| J 2.520 | K 2.559 | P 12.283 | ES 2.756 | depth 0.375 |
| S 0.375 | N-W 4.000 | U 1.625 | R 1.416 | D 6.250 |
| G 0.817 | O 12.431 | T 2.087 | H 0.531 | C 28.095 |
| AA NPT 1 1/2" | d1 A 4 | d2 A 4 | | |

Three-phase induction motor
 Frame 254T - IP55

23-SEP-2016



1 2 3 4 5 6 7 8

A
B
C
D
E
F

LOW VOLTAGE

HIGH VOLTAGE

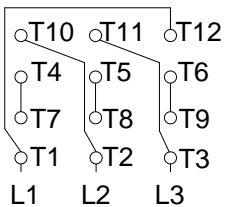
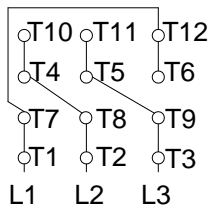

CONNECTIONS FOR STARTING ONLY:

LOW VOLTAGE

HIGH VOLTAGE

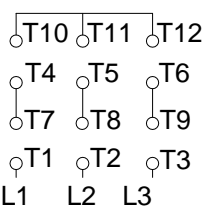
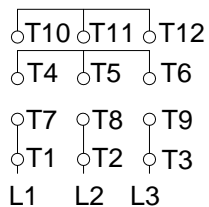

Notes: Downloaded from <http://dealerselectric.com>
Generated for Model #01518EP3EBM254T

Performed by:

Checked:

Customer:

Brake Motors : Three-Phase - High Efficiency

Three-phase induction motor
Frame 254T - IP55

23-SEP-2016

