



Dealers Industrial Equipment

No.:

Date: 23-SEP-2016

Customer :

TECHNICAL PROPOSAL

Three-phase induction motor - Squirrel cage rotor

Product line : W22 Cooling Tower Motors: NEMA Premium - TEAO

Catalog Number : 01518AT3ECT254T-W22

List Price : \$2,186

Notes:

Downloaded from <http://dealerselectric.com>

Generated for Model #01518AT3ECT254T-W22

Performed by:

Checked:



Dealers Industrial Equipment

No.:

Date: 23-SEP-2016

DATA SHEET Three-phase induction motor - Squirrel cage rotor

Customer :
Product line : W22 Cooling Tower Motors: NEMA Premium - TEAO

Frame : 254T
Output : 15 HP
Frequency : 60 Hz
Poles : 4
Full load speed : 1765 rpm
Slip : 1.94 %
Voltage : 208-230/460 V
Rated current : 39.8-36.0/18.0 A
Locked rotor current : 230/115 A
Locked rotor current (I_L/I_n) : 6.4
No-load current : 16.0/8.00 A
Full load torque : 44.0 lb.ft
Locked rotor torque : 230 %
Breakdown torque : 270 %
Design : B
Insulation class : F
Temperature rise : 80 K
Locked rotor time : 17 s (hot)
Service factor : 1.25
Duty cycle : S1
Ambient temperature : -20°C - +40°C
Altitude : 1000 m
Degree of Protection : IP55
Approximate weight : 251 lb
Moment of inertia : 2.6198 sq.ft.lb
Noise level : 64 dB(A)

	D.E.	N.D.E.
Bearings	6309 2RS-C3	6209 2RS-C3
Regreasing interval	---	---
Grease amount	---	---

Load	Power factor	Efficiency (%)
100%	0.83	92.4
75%	0.78	91.7
50%	0.68	91.0

Notes:
Downloaded from <http://dealerselectric.com>
Generated for Model #01518AT3ECT254T-W22

Performed by

Checked



Dealers Industrial Equipment

No.:

Date: 23-SEP-2016

PERFORMANCE CURVES RELATED TO RATED OUTPUT

Three-phase induction motor - Squirrel cage rotor

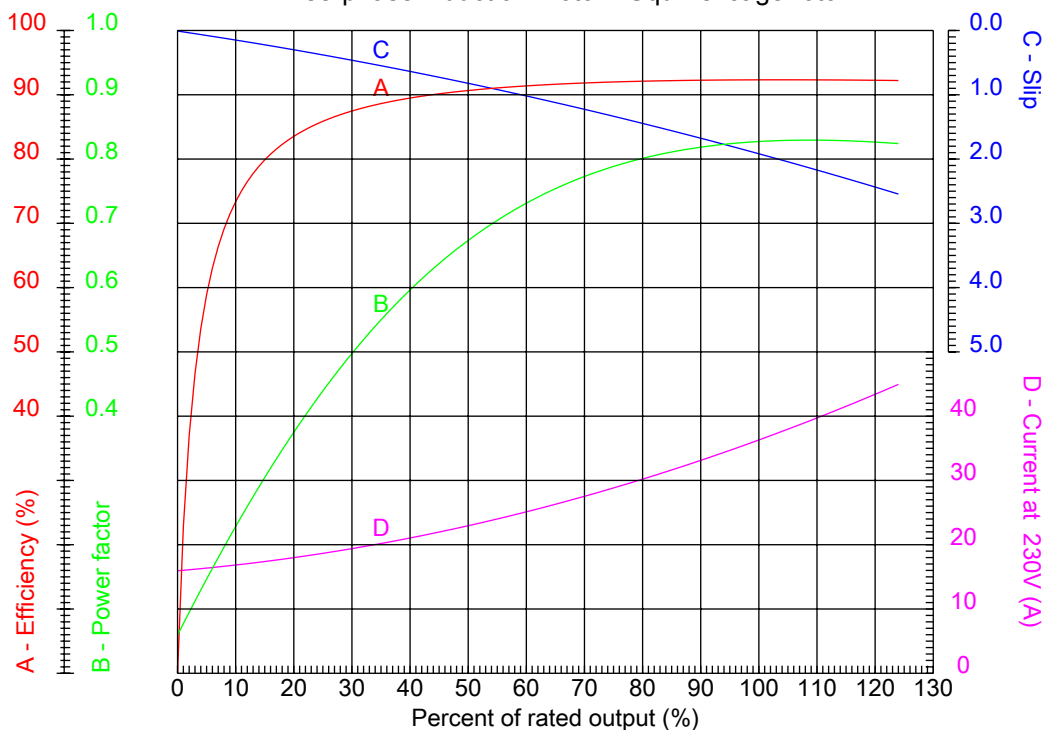

Customer :
 Product line : W22 Cooling Tower Motors: NEMA Premium - TEAO

Frame	: 254T	Locked rotor current (I _l /I _n)	: 6.4
Output	: 15 HP	Duty cycle	: S1
Frequency	: 60 Hz	Service factor	: 1.25
Full load speed	: 1765 rpm	Design	: B
Voltage	: 208-230/460 V	Locked rotor torque	: 230 %
Rated current	: 39.8-36.0/18.0 A	Breakdown torque	: 270 %
Insulation class	: F		

Notes:
 Downloaded from <http://dealerselectric.com>
 Generated for Model #01518AT3ECT254T-W22

Performed by

Checked



Dealers Industrial Equipment

No.:

Date: 23-SEP-2016

CHARACTERISTIC CURVES RELATED TO SPEED

Three-phase induction motor - Squirrel cage rotor

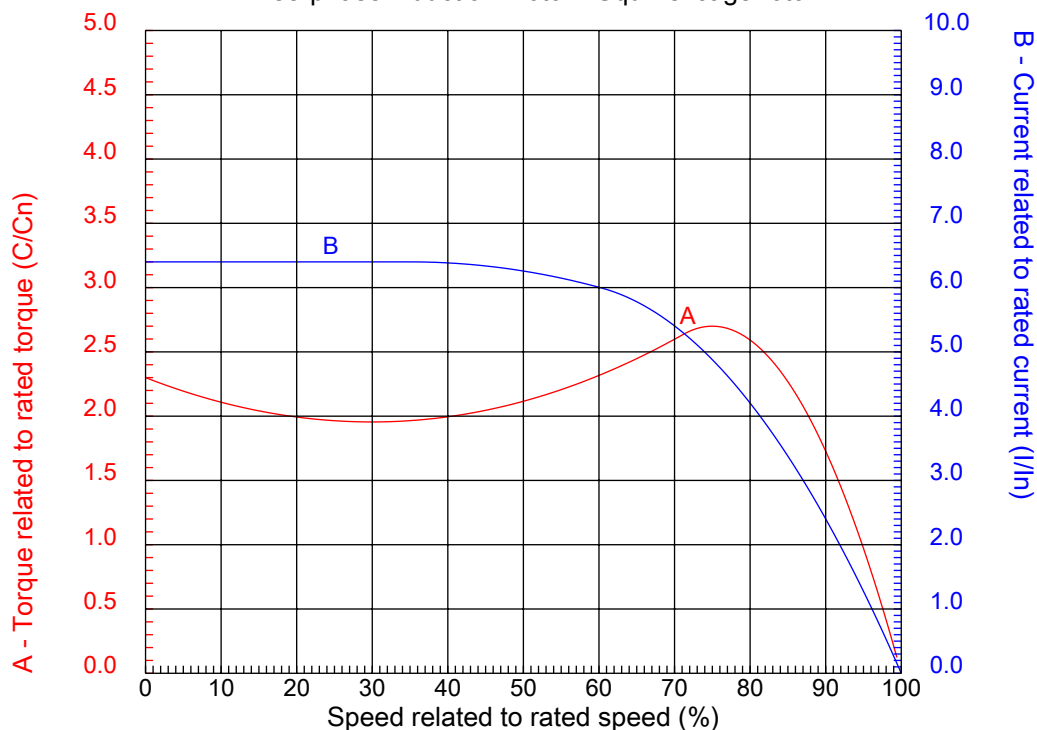

Customer :
Product line : W22 Cooling Tower Motors: NEMA Premium - TEAO

Frame	: 254T	Locked rotor current (I _l /I _n)	: 6.4
Output	: 15 HP	Duty cycle	: S1
Frequency	: 60 Hz	Service factor	: 1.25
Full load speed	: 1765 rpm	Design	: B
Voltage	: 208-230/460 V	Locked rotor torque	: 230 %
Rated current	: 39.8-36.0/18.0 A	Breakdown torque	: 270 %
Insulation class	: F		

Notes:
Downloaded from <http://dealerselectric.com>
Generated for Model #01518AT3ECT254T-W22

Performed by

Checked

1 2 3 4 5 6 7 8

A

B

C

D

E

F

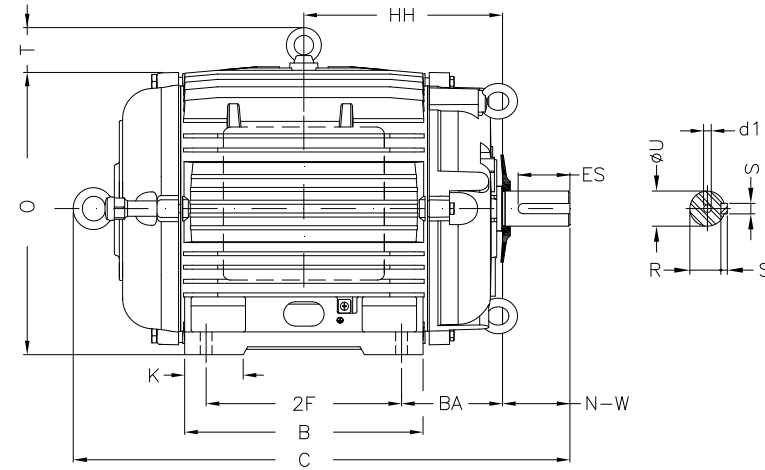
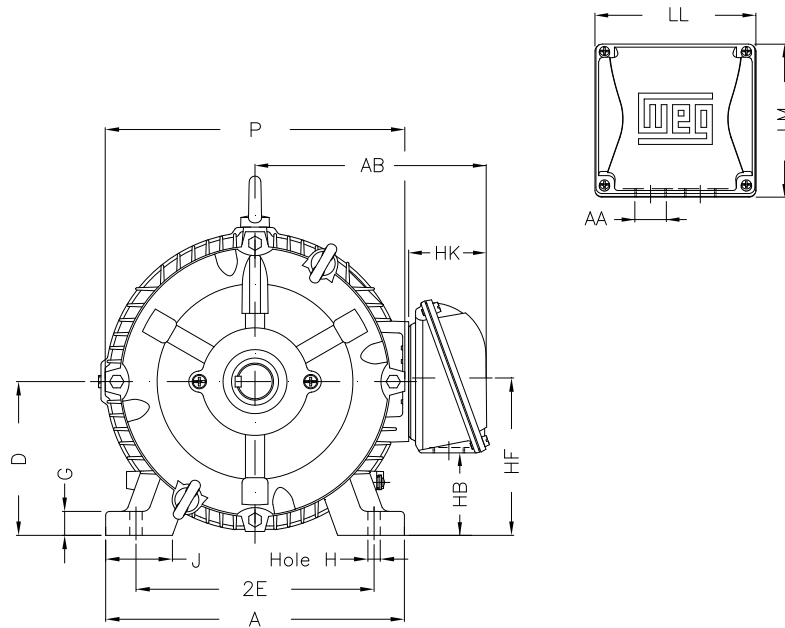

Notes: Downloaded from <http://dealerselectric.com>
Generated for Model #01518AT3ECT254T-W22

Performed by:

Checked:

Customer:

W22 Cooling Tower Motors: NEMA Premium - TEAO

Three-phase induction motor
Frame 254T - IP55

23-SEP-2016



2E 10.000	J 2.539	A 12.126	P 12.480	AB 10.483
2F 8.252	K 2.559	B 10.000	BA 4.250	U 1.625
N-W 4.000	ES 2.756	S 0.375	R 1.416	depth 0.375
D 6.250	G 0.827	HB 3.061	O 12.598	T 2.087
HF 6.565	HH 8.376	HK 3.976	H 0.531	C 21.594
LL 7.815	LM 7.480	AA NPT 1 1/2"	d1 A 4	

1 2 3 4 5 6 7 8

A
B
C
D
E
F

LOW VOLTAGE

HIGH VOLTAGE



CONNECTIONS FOR STARTING ONLY:

LOW VOLTAGE

HIGH VOLTAGE



Notes: Downloaded from <http://dealerselectric.com>
Generated for Model #01518AT3ECT254T-W22

Performed by:

Checked:

Customer:

W22 Cooling Tower Motors: NEMA Premium - TEAO

Three-phase induction motor
Frame 254T - IP55

23-SEP-2016

