



Dealers Industrial Equipment

No.:

Date: 23-SEP-2016

Customer :

TECHNICAL PROPOSAL

Three-phase induction motor - Squirrel cage rotor

Product line : Three-Phase : Explosion Proof - NEMA Premium

Catalog Number : 01512XT3H284T

List Price : \$4,048

Notes:

Downloaded from <http://dealerselectric.com>

Generated for Model #01512XT3H284T

Performed by:

Checked:



Dealers Industrial Equipment

No.:

Date: 23-SEP-2016

DATA SHEET Three-phase induction motor - Squirrel cage rotor

Customer :
 Product line : Three-Phase : Explosion Proof - NEMA Premium

Frame : 284T
 Output : 15 HP
 Frequency : 60 Hz
 Poles : 6
 Full load speed : 1180 rpm
 Slip : 1.67 %
 Voltage : 575 V
 Rated current : 14.0 A
 Locked rotor current : 101 A
 Locked rotor current (I_L/I_n) : 7.2
 No-load current : 5.60 A
 Full load torque : 65.9 lb.ft
 Locked rotor torque : 250 %
 Breakdown torque : 260 %
 Design : B
 Insulation class : F
 Temperature rise : 80 K
 Locked rotor time : 25 s (hot)
 Service factor : 1.15
 Duty cycle : S1
 Ambient temperature : -20°C - +40°C
 Altitude : 1000 m
 Degree of Protection : IP55
 Approximate weight : 463 lb
 Moment of inertia : 7.0742 sq.ft.lb
 Noise level : 59 dB(A)

	D.E.	N.D.E.
Bearings	6311 2RS-C3	6211 2RS-C3
Regreasing interval	---	---
Grease amount	---	---

Load	Power factor	Efficiency (%)
100%	0.86	91.7
75%	0.83	91.7
50%	0.74	91.0

Notes:
 Downloaded from <http://dealerselectric.com>
 Generated for Model #01512XT3H284T

Performed by

Checked



Dealers Industrial Equipment

No.:

Date: 23-SEP-2016

PERFORMANCE CURVES RELATED TO RATED OUTPUT

Three-phase induction motor - Squirrel cage rotor

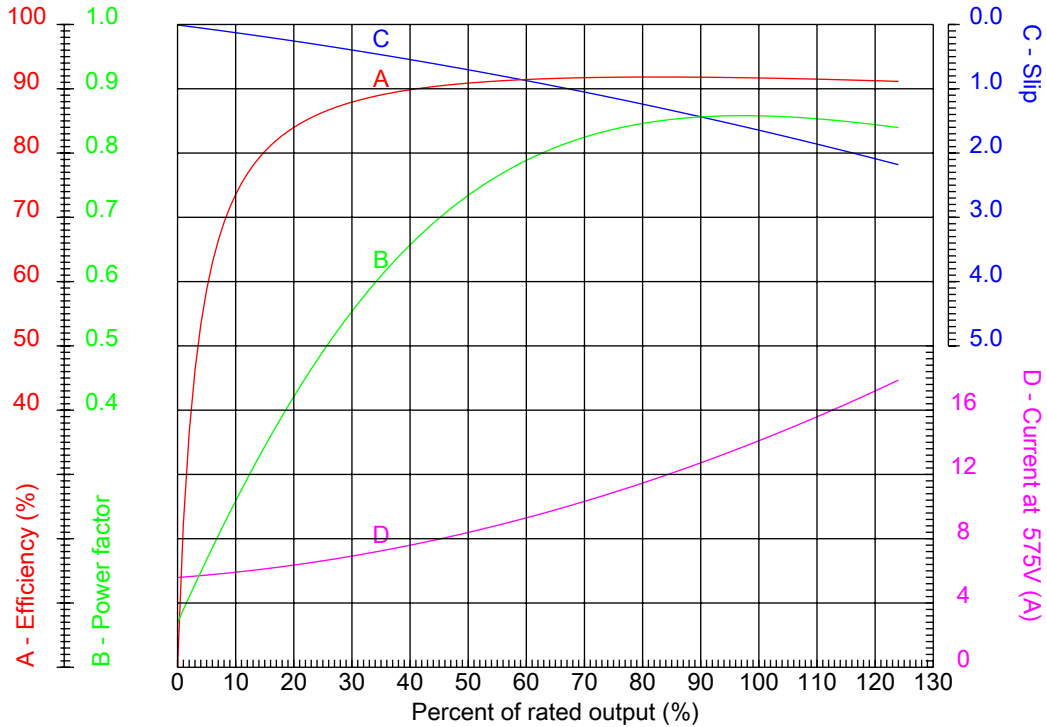

Customer :
 Product line : Three-Phase : Explosion Proof - NEMA Premium

Frame : 284T	Locked rotor current (I _L /I _n) : 7.2
Output : 15 HP	Duty cycle : S1
Frequency : 60 Hz	Service factor : 1.15
Full load speed : 1180 rpm	Design : B
Voltage : 575 V	Locked rotor torque : 250 %
Rated current : 14.0 A	Breakdown torque : 260 %
Insulation class : F	

Notes:
 Downloaded from <http://dealerselectric.com>
 Generated for Model #01512XT3H284T

Performed by

Checked



Dealers Industrial Equipment

No.:

Date: 23-SEP-2016

CHARACTERISTIC CURVES RELATED TO SPEED

Three-phase induction motor - Squirrel cage rotor

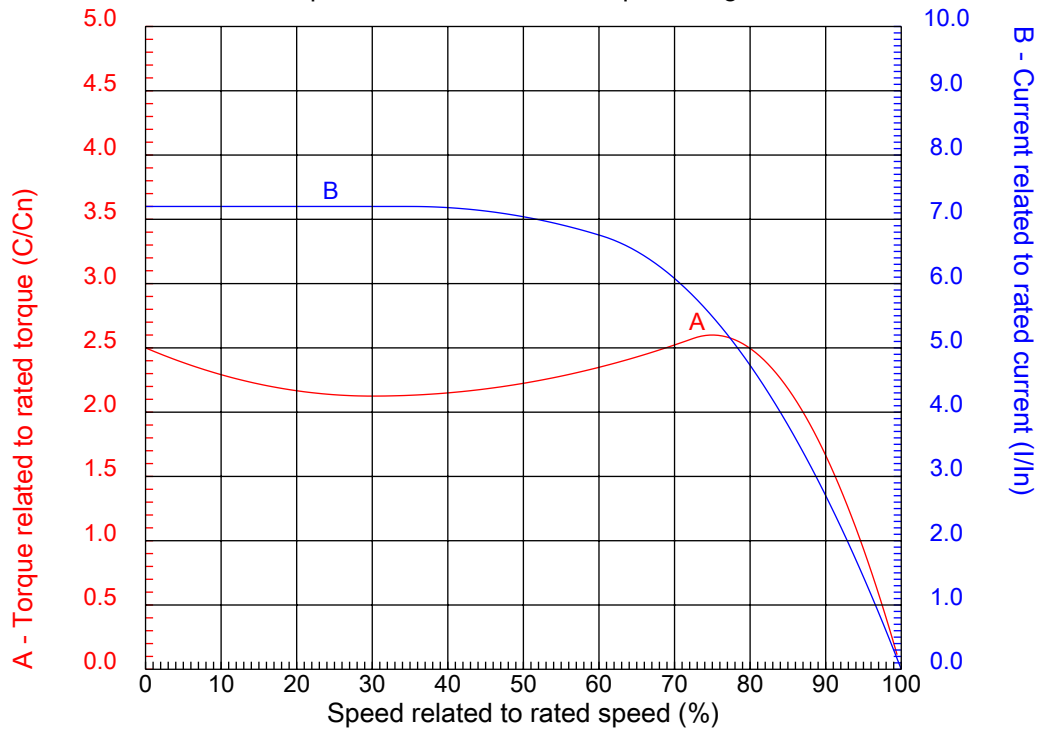

Customer :
Product line : Three-Phase : Explosion Proof - NEMA Premium

Frame	: 284T	Locked rotor current (I _l /I _n)	: 7.2
Output	: 15 HP	Duty cycle	: S1
Frequency	: 60 Hz	Service factor	: 1.15
Full load speed	: 1180 rpm	Design	: B
Voltage	: 575 V	Locked rotor torque	: 250 %
Rated current	: 14.0 A	Breakdown torque	: 260 %
Insulation class	: F		

Notes:
Downloaded from <http://dealerselectric.com>
Generated for Model #01512XT3H284T

Performed by

Checked

1 2 3 4 5 6 7 8

A

B

C

D

E

F

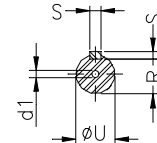
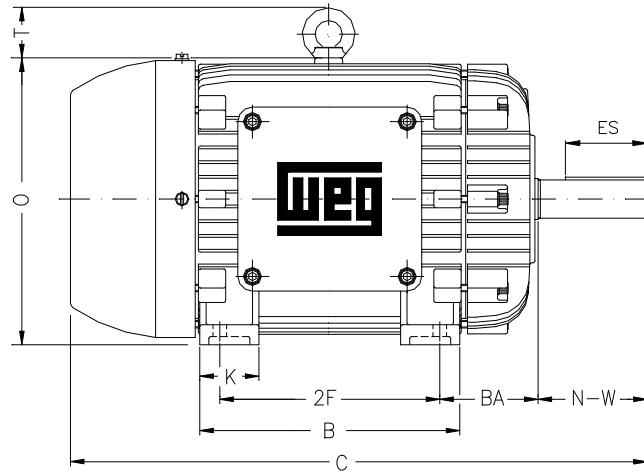
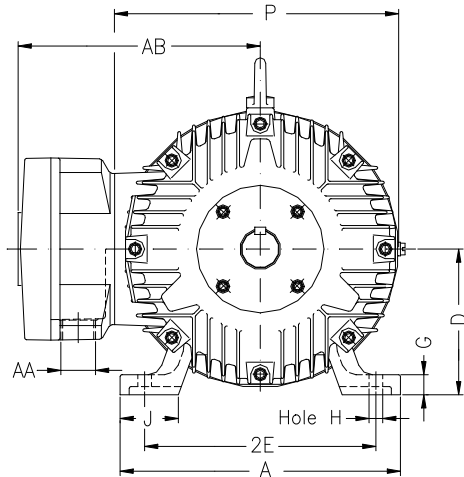

Notes: Downloaded from <http://dealerselectric.com>
Generated for Model #01512XT3H284T

Performed by:

Checked:

Customer:

Three-Phase : Explosion Proof - NEMA Premium

Three-phase induction motor
Frame 284T - IP55

23-SEP-2016



2E 11.000	A 13.780	2F 9.500	B 11.575	BA 4.750
J 3.150	K 2.953	P 14.094	ES 3.149	depth 0.500
S 0.500	N-W 4.622	U 1.875	R 1.594	AB 11.850
D 7.000	G 1.024	O 14.362	T 2.441	H 0.531
C 26.407	AA NPT 1 1/2"	d1 A 4	d2 A 4	

1 2 3 4 5 6 7 8

A
B
C
D
E
F

RUN

ONLY FOR START



Notes: Downloaded from http://dealerselectric.com Generated for Model #01512XT3H284T		
Performed by:		
Checked:		
Customer:		
Three-Phase : Explosion Proof - NEMA Premium		
Three-phase induction motor Frame 284T - IP55	23-SEP-2016	