



Dealers Industrial Equipment

No.:

Date: 13-SEP-2016

Customer :

TECHNICAL PROPOSAL

Three-phase induction motor - Squirrel cage rotor

Product line : W22 NEMA Premium - Ball Bearings

Catalog Number : 01012ET3H256T-W22

List Price : \$2,396

Notes:

Downloaded from <http://dealerselectric.com>

Generated for Model #01012ET3H256T-W22

Performed by:

Checked:



Dealers Industrial Equipment

No.:

Date: 13-SEP-2016

DATA SHEET Three-phase induction motor - Squirrel cage rotor

Customer :
 Product line : W22 NEMA Premium - Ball Bearings

Frame : 254/6T
 Output : 10 HP
 Frequency : 60 Hz
 Poles : 6
 Full load speed : 1175 rpm
 Slip : 2.08 %
 Voltage : 575 V
 Rated current : 10.3 A
 Locked rotor current : 67.1 A
 Locked rotor current (I_L/I_n) : 6.5
 No-load current : 4.80 A
 Full load torque : 44.1 lb.ft
 Locked rotor torque : 230 %
 Breakdown torque : 280 %
 Design : B
 Insulation class : F
 Temperature rise : 80 K
 Locked rotor time : 26 s (hot)
 Service factor : 1.25
 Duty cycle : S1
 Ambient temperature : -20°C - +40°C
 Altitude : 1000 m
 Degree of Protection : IP55
 Approximate weight : 289 lb
 Moment of inertia : 4.4311 sq.ft.lb
 Noise level : 59 dB(A)

	D.E.	N.D.E.
Bearings	6309 C3	6209 C3
Regreasing interval	20000 h	20000 h
Grease amount	13 g	9 g

Load	Power factor	Efficiency (%)
100%	0.80	91.0
75%	0.74	91.0
50%	0.63	90.2

Notes:
 Downloaded from <http://dealerselectric.com>
 Generated for Model #01012ET3H256T-W22

Performed by

Checked



Dealers Industrial Equipment

No.:

Date: 13-SEP-2016

PERFORMANCE CURVES RELATED TO RATED OUTPUT

Three-phase induction motor - Squirrel cage rotor

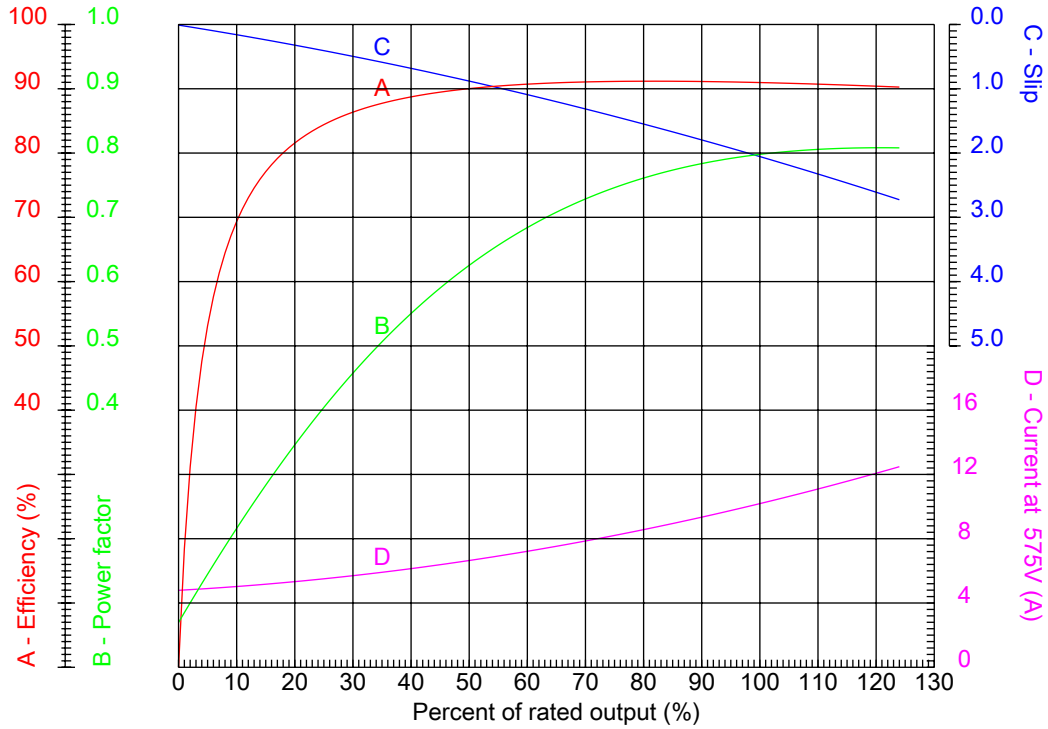

Customer :
Product line : W22 NEMA Premium - Ball Bearings

Frame : 254/6T	Locked rotor current (I _L /I _n) : 6.5
Output : 10 HP	Duty cycle : S1
Frequency : 60 Hz	Service factor : 1.25
Full load speed : 1175 rpm	Design : B
Voltage : 575 V	Locked rotor torque : 230 %
Rated current : 10.3 A	Breakdown torque : 280 %
Insulation class : F	

Notes:
Downloaded from <http://dealerselectric.com>
Generated for Model #01012ET3H256T-W22

Performed by

Checked



CHARACTERISTIC CURVES RELATED TO SPEED

Three-phase induction motor - Squirrel cage rotor

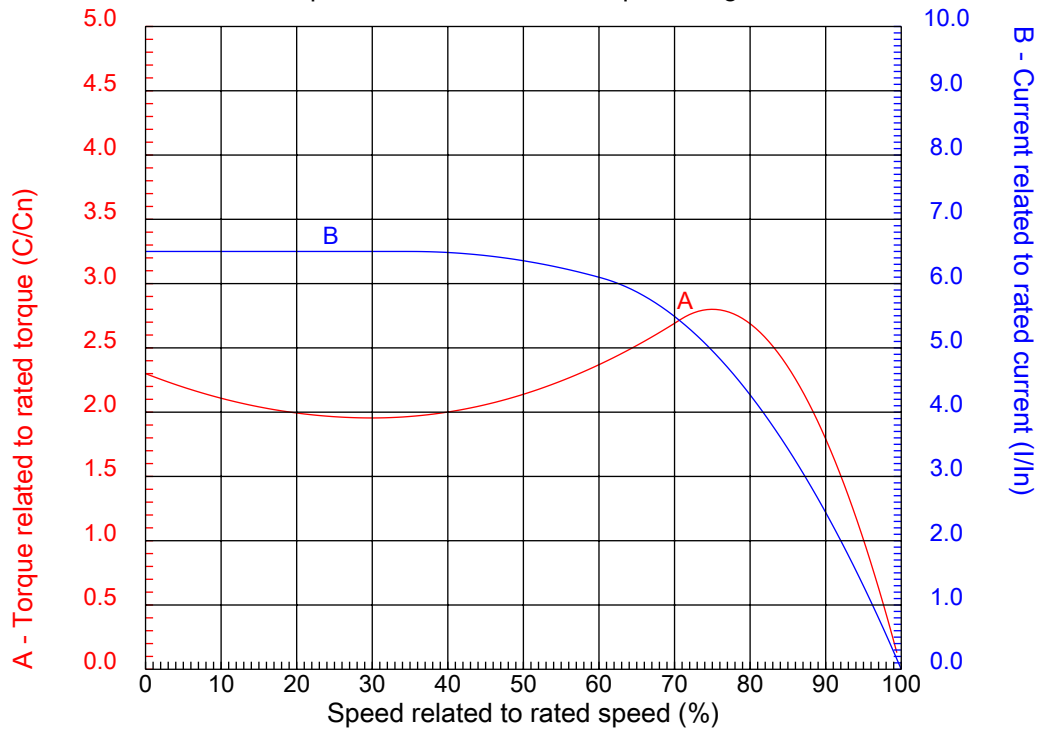

Customer :
Product line : W22 NEMA Premium - Ball Bearings

Frame	: 254/6T	Locked rotor current (I _l /I _n)	: 6.5
Output	: 10 HP	Duty cycle	: S1
Frequency	: 60 Hz	Service factor	: 1.25
Full load speed	: 1175 rpm	Design	: B
Voltage	: 575 V	Locked rotor torque	: 230 %
Rated current	: 10.3 A	Breakdown torque	: 280 %
Insulation class	: F		

Notes:
Downloaded from <http://dealerselectric.com>
Generated for Model #01012ET3H256T-W22

Performed by

Checked

1 2 3 4 5 6 7 8

A

B

C

D

E

F

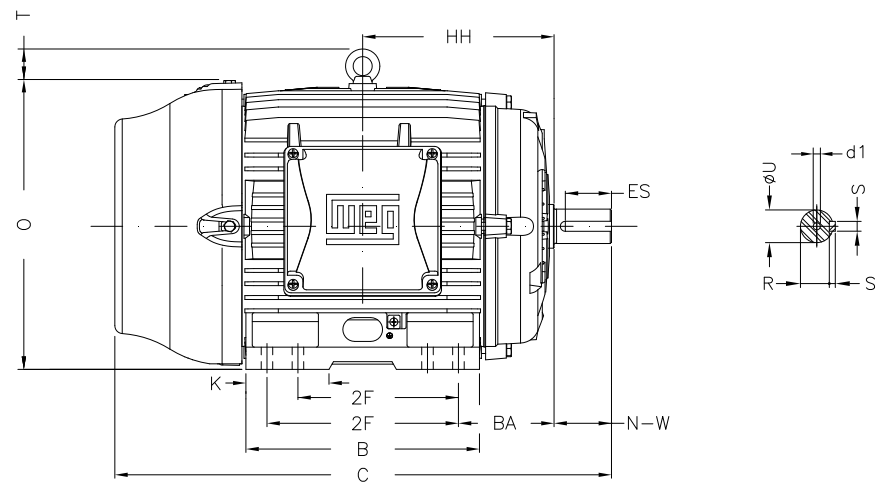
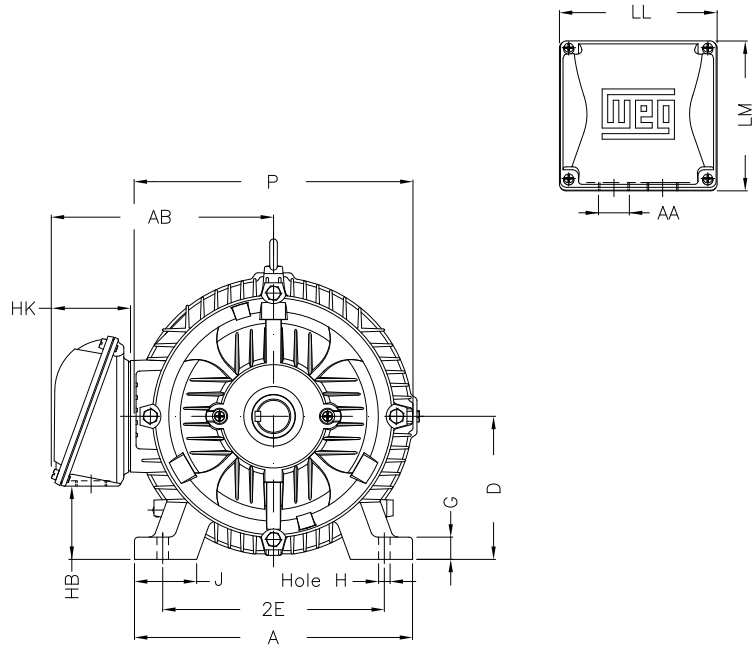

Notes: Downloaded from <http://dealerselectric.com>
Generated for Model #01012ET3H256T-W22

Performed by:

Checked:

Customer:

W22 NEMA Premium - Ball Bearings

Three-phase induction motor
Frame 254/6T - IP55

13-SEP-2016



2E 10.000	J 2.539	A 12.126	P 12.953	AB 10.483
2F 8.252/10.000	K 2.559	B 11.732	BA 4.250	FBA 6.852
U 1.625	N-W 4.000	ES 2.756	S 0.375	R 1.416
depth 0.375	D 6.250	G 0.827	HB 3.061	O 12.598
T 2.087	HF 6.565	HH 9.250	HK 3.976	H 0.531
C 24.945	LL 7.815	LM 7.480	AA NPT 1 1/2"	d1 A 4

1 2 3 4 5 6 7 8

A
B
C
D
E
F

RUN

ONLY FOR START



Notes: Downloaded from http://dealerselectric.com Generated for Model #01012ET3H256T-W22		
Performed by:		
Checked:		
Customer:		
W22 NEMA Premium - Ball Bearings		
Three-phase induction motor Frame 254/6T - IP55	13-SEP-2016	